

PHILCO

PARTS and ACCESSORIES

Catalog

EMPIRE STATE DISTRIBUTORS, INC.

SARATOGA & ONTARIO STS.

COHOES, N. Y.

PHONE COHOES 2120

JANUARY, 1949

3rd Edition of
The PHILCO
PARTS and ACCESSORIES *Catalog*

This new edition of the Philco Parts and Accessories Catalog brings you the latest and most complete information on repair parts and consumer sale accessories for Philco and all other makes of Radios, Television, Refrigeration, and Air Conditioning parts are also included. You will find the new edition not only convenient in ordering, but also excellent as a reference publication for your technical library.

This new catalog includes factual material on most of the standard and special parts used in these fields — information culled from blueprints, design specifications, laboratory tests, and the wide experience of Philco technical men.

Special sections are included for the convenience of servicemen, dealers, and distributors. For servicemen there is the complete price list for all items—including replacement parts—sold by the Accessory Division. And for dealers and distributors, sections on promotional material and auto radios are included.

The result is this complete and easily read catalog, offering an outstanding line of products by PHILCO, "Famous for Quality the World Over."

COPYRIGHT, JANUARY 1949, PHILCO CORPORATION

INDEX

A	PAGE		PAGE
"A" Radio Batteries	26	Carbon Resistors	93-95
Acorn Nuts	119	Cartridges, Crystal	99
Adapter Kits, Phono	100	Cements	
Adjustable Resistors	97	Plastic	109
Adjustable Shims	109	Polystyrene	110
Aerials	46-52	Radio and Speaker	109
Auto	50-52	Rubber	110
Couplers	48	Solvent	109
Farm Kit	49	Chassis Mounts	116
FM	49	Chokes, Filter	80
Mounting Brackets	48	Cleaners, Refrigerator	126
Outdoor Kits	49	Clips	
Television	46-47	Dial Cord	117
Air Conditioning	127	Fahnestock	117
Filters	127	Fuse	118
Parts Price List	232-234	Spring	117
Power Cables	126	Clutch Gear	104
Window Lock	127	Coaxial Cables	48
Window Silencer	127	Coils	61
Album Length Record Player	100	Compression Shaft Seals	124
Alignment Generators, Visual	55	Compression Springs	116
Alignment Tools	108	Condensers	83-89
Angle Brackets	117	Ceramic	86
Antenna Coils	61	Dry Electrolytic	87-89
Anti-Rock Bumpers	125	Mica and Silver Mica	85
Arrestors, Lightning	48	Mounting Plates	88
Auto Radio Accessories	43-45	Paper	84
Aerial Connectors	44	Part Number System	83
Aerial Lead-in Extension	52	Cone Patches	109
Cables for Nash Cars	45	Connectors	
Foot-Control Kits	45	Auto Aerial	44
Fuses	43	Speaker	123
Fuse Holders	43	Contact Bands, for Adj. Resistors	97
Fuse Insulators	43	Contact Cleaners	110
Ignition Noise Suppressors	44	Control Kit, Foot	49
Speaker Kits, Rear Seat	44	Controls	
Wheel-Static Eliminators	44	Bias	62
Auto Radio Knob Kit	121	Tone	62
Auto Radio Parts Price List	185-221	Volume	62
Auto Radio Replacement Parts List	172-183	Universal	62
Auto Radio Sales Promotional Material	239	Conversion Transformers, Freezer and Refrigerator	82
Auto Radio Tube Compliments	7	Cord, Dial	113
		Cord, Line	122
		Cord, Strainreliefs	116
		Cotter Pins	119
		Couplers, Aerial	48
		Crosshatch Generators	53
		Dial	
		Cables, Bronze	113
		Cord	113
		Cord Clips	117
		Cord Dressing	112
		Drive Belts	113
		Drive Springs	116
		Windows	113
		Dry Electrolytic Condensers	
		Exact-Replacement, Clamp-Mounting	89
		Mounting Plates	88
		Tab Mounting	88
		Tubular Self-Mounting	87
		Universal Clamp-Mounting	89
		Dynamic Pickups	98
		Dynamic Tester	57
		Duoflex Auto Aerial	52
		E	
		Electrolytic Condenser	\$7-99
		Self Mounting	87
		Tab Mounting	88
		Clamp Mounting	89
		Electrodynamic Speakers	75
		Electronic Circuit Master	54
		Electronic Hardware Assortment	119
		Escutcheon Pins	117
		Escutcheon Screws	119
		Expansion Springs	116
		Eyelets	119
		F	
		Fahnestock Clips	117
		Farm Aerial Kits	49
		Farm Radio Batteries	28
		Farm Radio Philco Battery	
		Replacements	29
		Feet, Cabinet	120
		Felt Washers	118
		Fender Aerials	50-51
		Filters, Air Conditioning	127
		Filter Chokes	80
		Flashlight and All-Purpose Batteries	28
		Flock, Felt	
		Finish Kit	111
		Undercoat	111
		Undercoat Thinner	111
		FM Aerial Kit	49
		FM Mast Kit	49
		FM Reflector Kit	49
		Foot-Control Kit	45
		Freezer and Refrigerator Conversion	
		Transformers	82
		Furniture Polish	114
		Fuse	
		Clips	118
		Holders	43
		Insulators	43
		Fuses	43
		G	
		Gram Scale	100
		Grid Caps	117
		Grille, Cloth	111
		Grille, Screening	111
		Grommets	116
		H	
		Hairpins	119
		Hardware	115-119
		Hex Nuts	119
		High-Frequency Probe	54
		High-Voltage Probe	54
		Hole Cutter, Metal	105
		I	
		Ice-Cube Tray	126
		I-F Transformers	80
		Ignition Noise Suppressors	44
		Insulating	
		Spacers	117
		Tubing	112
		Washers	118
		Insulation, Refrigerator	125
		Insulators	
		Fuse	43
		Standoff	48
		J	
		Junior Scope	56
		K	
		Key Wrenches	108
		Kits	
		Adapter Phonograph	100
		Auto Radio Knobs	121
		Farm Aerial	49
		Flock Finish	111
		FM Aerial	49
		FM Mast	49
		FM Reflector	47, 49
		Foot Control	45
		Fuse Holder	43
		Motor Conversion, Phono	105
		Outdoor Aerial	49
		Rear Seat Speaker	45
		Television-Aerial-and-Mast	46-47
		Tool	108
		Knob	
		Kit	121
		Springs	116
		Washers	118
		Knobs	121
		L	
		Lacquer	
		Cabinet	114
		Refrigerator	125
		Thinner	125
		Lamps, Miniature	9
		Lightning Arrestor	48
		Line Cords	122
		Lock Washers	118
		Loktal Tube Sockets	123
		Lock, Window	127
		Lubricants	110, 112
		Lugs	117

M	PAGE
Machine Screws	115
Mast Kits	
FM Aerial	49
Television Aerial	46
Metal Hole Cutter	105
Metal Spacers	117
Metal Washers	118
Mica Condensers	85
Miniature Lamps	9
Miniature Sockets	58, 123
Mounting Brackets	48
Mounting Nuts	119
Mounts, Chassis	116

N	
Needles	
Phonograph	102, 103
Recording	103
Noise Suppressors	44
Nuts	
Acorn	119
Hex	119
Mounting	119
Speed	118
Thumb	119
Wing	119

O	
Octal Tube Sockets	123
Offset Screw Driver	107
Oscilloscope	56
Oscillator Coils	61
Ornamental Head Screws	115
Outdoor Aerial Kits	49
Output Transformers	81

P	
Paper Condensers	84
Parts Price List	
Air Conditioner	229-231
Radio and Television	185-228
Refrigeration	222-228
Parts Replacement List	
Auto Radio	172-183
Home Radio	134-171
Television	128-133
Permanent-Magnet Speakers	75
Phillips Screw Driver	107
Phone Tips	117
Phono Parts	98-105
Adapter Kit	100
Album Length Record Player	100
Cartridges	99
Changers	101
Changer Bases	101
Clutch Gears	104
Gram Scale	100
Light-Beam Tone Arm	104
Motor Conversion Kits	105
Motor Drives	99
Motor Kits	102
Needles	102, 103
Pickups	98
Recording Blanks	102
Set Screws	115
Stroboscope Disc	100
Trip Conversion Kits	105
Photo Cell, Selenium	122
Pliers	106
Plugs	
Battery	123
Snaphole	118
Police-Band Coils	61
Polish, Refrigerator	126
Portable Radio Battery Replacements	32-42
Portable Radio Tube Complements	7
Power Cables, Air Conditioner	127
Power Transformers	
Master	78-79
Universal	76-77
Portable Radio Batteries	27
Portable Radio Battery	
Replacements	29, 32-42
Probes	54
Push-Button Knobs	121

R	
Radio	
Auto	
Parts Price List	187-224
Replacement Parts List	172-183

	PAGE
Cabinets	120
Home	
Parts Price List	187-224
Replacement Parts List	134-171
Tubes	3-4
Rear Seat Speaker Kit	45
Record Changer	
Bases	101
Clutch Gears	104
Motor Kits	102
Trip-Conversion Kits	105
Recording	
Blanks	102
Needles	102, 103
Record Player, Album Length	100
Reflector Kits	47
Refrigeration	124-126
Bumpers	125
Compression Shaft Seals	124
Ice-Cube Tray	126
Insulation	125
Lacquer	125
Parts Price List	225-231
Polish	126
Shelf Studs	124
Thinner, Lacquer	125
Refrigerator Conversion Transformers	82
Resistors	93-97
Adjustable	97
Carbon	93-95
Contact Bands	97
Part Number System	95
Wire-Wound	96-97
Retaining Rings	118
R-F Coils	61
R-F Signal Generators	59
Rivets	119
Rubber Washers	116
Rubbing Compound	114

S	
Sales Aids, Service	90-92
Sales Promotional Material	235-240
Scope, Junior	56
Screw Drivers	106-108
Alignment	107-108
Offset	107
Phillips	107
Screws	115-119
Selenium Photo Cell	122
Selenium Rectifier	122
Service Aids	109-114
Cements	109, 110
Cone Patches	109
Contact Cleaner	110
Dial Cables	113
Dial-Cord Dressing	112
Dial Cords	113
Dial Windows	114
Drive Belts	113
Felt Flock	111
Flock Finish Kit	111
Flock, Undercoat	111
Furniture Polish	114
Grille Cloth	111
Lacquers	112, 114
Lubricants	110, 112
Screening	111
Set Screws	115
Sheet-Metal Screws	115
Shelf Studs	124
Shims	109
Short-Wave Coil	61
Side-Cowl Aerials	50, 51, 52
Signal Generators	59
Sockets, Tube	123
Socket, Tube Tester	58
Socket Wrenches	107
Soldering Lugs	117
Snaphole Plugs	118
Spacers	117
Spade Bolts	115
Spaghetti	112
Speaker	
Baffles	116
Cone Patches	109

	PAGE
Connectors	123
Rear Seat	45
Shims	109
Universal	75
Special-Purpose Tubes	4
Speed Nuts	118
Springs	116
Stains, Cabinet	114
Standoff Insulators	48
Step-down Transformers	82
Stroboscope Disc	100
Strainreliefs, Cord	116
Suppressors, Ignition Noise	44

T	
Television	46, 47
Aerials	46, 47
Parts Price List	185-228
Replacement Parts List	128-133
Receiver Tube Complements	8
Picture Tubes	4
Tester, Dynamic	57
Test Equipment	53-59
Crosshatch Generator	53
Dynamic Tester	57
Electronic Circuit Master	54
Junior Scope	56
Signal Generators	59
Tube Complements	8
Tube Tester	58
Visual Alignment Generator	55
Thinner, Lacquer	125
Thumb Nuts, Knurled	119
Tone Arms	98
Light-Beam, Parts	104
Tone Controls	62
Tools	105-108
Alignment	108
Kits	108
Metal Hole Cutter	105
Pliers	106
Screw Drivers	106-108
Tuning Wand	108
Wrenches	107, 108
Top-Cowl Aerials	50, 51
Transformers	76-82
Intermediate-Frequency	60
Output	81
Power	76-79
Refrigerator and Freezer	82
Step-Down	82
Transmission Lines	48
Tray, Ice-Cube	126
Trimounts	118
Tube Sockets	123
Tube Tester	58
Tubes	3-24
Ballast	10-24
Complements of Late Philco Radios	5-8
Radio	3-5
Special Purpose	5
Television Picture	5

V	
Vernier-Drive Knobs	121
Vibrators	63-74
Replacements for All Auto Radio	
Models	66-74
Replacements for Vibrators of Other	
Makes	64-65
Schematic Wiring	63
Visual Alignment Generator	55
Volume Controls, Universal	62

W	
Washers	115, 117, 118
Wheel-Static Eliminator	44
Window Lock, Air Conditioner	127
Window Silencer, Air Conditioner	127
Wing Nuts	119
Wire-Wound Resistors	96-97
Wood Screws	118
Wrenches	
Alignment	108
Key	108
Socket	107



PHILCO RADIO TUBES

Scientifically engineered, precision-built by Philco, and subjected to thorough tests in every stage of manufacture, Philco tubes give long, dependable, and economical service.

Philco's tremendous public acceptance—plus the fact that there are more Philco tube sockets than any other make—guarantees you more sales and **BIGGER PROFITS WITH PHILCO TUBES!**

TYPE	LIST PRICE	TYPE	LIST PRICE	TYPE	LIST PRICE	TYPE	LIST PRICE	TYPE	LIST PRICE
0A4G	\$1.35	1LC5	2.65	3V4	2.00	6AR5	1.65	6J5GT	1.50
OY4	4.80	1LC6	2.65	5AZ4	1.35	6AS7G	4.90	6J6	2.90
OZ4	2.20	1LD5	2.65	5T4	3.90	6AT6	1.50	6J6/TV	3.20
OZ4G	2.20	1LE3	2.65	5U4G	1.50	6AU6	2.00	6J7	2.00
1A3	2.20	1LG5	2.65	5V4G	2.40	6AV6	1.50	6J7GT	2.00
1A4P	3.90	1LH4	2.65	5W4	2.65	6B4G	3.20	6J8G	3.20
1A5GT	1.80	1LN5	2.65	5W4GT	1.65	6B5	3.90	6K5GT	2.40
1A6	3.20	1NSGT	2.00	5X4G	1.80	6B6G	2.20	6K6GT	1.50
1A7GT	2.00	1PSGT	2.65	5Y3G	1.05	6B7	3.20	6K6GT/TV	2.00
1B3GT/TV	3.20	1QSGT	2.65	5Y3GT	1.05	6B8	3.20	6K7	1.65
1B4P	3.90	1R4/1294	2.20	5Y4G	1.50	6B8G	3.20	6K7G	1.65
1B5/25S	3.20	1R5	2.00	5Z3	1.80	6BA6	1.80	6K8	2.40
1B7GT	3.20	1S4	2.40	5Z4	2.65	6BD6	2.00	6K9GT	2.40
1C5GT	2.20	1S5	1.80	6A3	3.20	6BE6	1.30	6L3G	2.65
1C6	3.20	1T4	2.00	6A5G	3.90	6BG6G/TV	4.80	6L6	3.55
1C7G	3.20	1T5GT	2.65	6A6	2.65	6BH6	2.00	6L6G	2.90
1D5GP	3.90	1U4	2.00	6A7	2.00	6BJ6	2.00	6L7	2.40
1D7G	3.20	1U5	1.80	6A8	2.00	6C4	1.65	6L7G	2.90
1D8GT	3.90	1V	2.20	6A8GT	2.00	6C5	1.65	6N6G	3.90
1E5GP	3.90	2A3	3.20	6AB5/6N5	2.65	6C5GT	1.65	6N7	2.40
1E7GT	3.90	2A5	2.20	6AB7/1853	3.20	6C6	2.00	6N7GT	2.40
1F4	2.65	2A6	2.65	6AC5GT	2.90	6C8G	3.20	6P5GT	2.40
1F5G	2.65	2A7	2.65	6AC7/1852	2.90	6D6	1.65	6Q7	2.00
1G4GT	2.65	2B7	2.65	6AD7G	3.20	6D8G	3.20	6Q7GT	1.80
1G5G	2.65	2E5	2.65	6AF6G	2.65	6E5	2.20	6R7	2.65
1G6GT	2.65	3A8GT	4.80	6AG5	2.65	6F5	1.65	6R7GT	2.65
1H4G	2.20	3B7/1291	2.65	6AG5/TV	2.90	6F5GT	1.65	6S7G	3.20
1H5GT	1.65	3C6/XXB	3.20	6AG7	3.20	6F6	2.00	6S8GT	2.65
1H6GT	3.20	3D6/1299	2.65	6AH6	3.90	6F6G	1.65	6SA7	1.65
1J6GT	3.20	3E6	2.65	6AK5	1.95	6F6GT	1.65	6SA7GT	1.65
1L4	2.00	3LF4	2.65	6AL5	2.00	6F7	3.20	6SB7Y	2.40
1LA4	2.65	3Q4	2.20	6AL5/TV	2.40	6F8G	3.20	6SC7	2.00
1LA6	2.65	3Q5GT	2.40	6AL7GT	2.65	6G6G	2.65	6SD7GT	2.90
1LB4	2.65	3S4	2.00	6AQ5	2.00	6H6	1.65	6SF5	1.65
				6AQ6	1.80	6H6GT	1.65	6SF5GT	1.80
						6J5	1.50	6SF7	2.00



PHILCO RADIO TUBES (Cont.)

TYPE	LIST PRICE	TYPE	LIST PRICE	TYPE	LIST PRICE	TYPE	LIST PRICE	TYPE	LIST PRICE		
6SG7	2.00	7C6	1.80	12Q7GT	1.80	25Z5	1.50	71A	2.00		
6SH7	2.20	7C7	1.80	12S8GT	2.65	25Z6GT	1.35	75	1.65		
6SJ7	1.65	7E5	2.65	12SA7	1.65	26	1.80	76	1.65		
6SJ7GT	1.65	7E6	1.80	12SA7GT	1.65	27	1.50	77	1.65		
6SK7	1.65	7E7	2.20	12SC7	2.20	30	2.00	78	1.65		
6SK7GT	1.65	7F7	2.20	12SF5GT	2.00	31	2.65	79	2.65		
6SL7GT	2.40	7F7/TV	2.65	12SF7	2.00	32	3.55	80	1.15		
6SN7GT	2.20	7F8	2.65	12SG7	2.00	32L7GT	3.20	81	3.90		
6SQ7	1.50	7G7/1232	2.65	12SH7	2.20	33	3.20	82	2.65		
6SQ7GT	1.50	7H7	2.00	12SJ7GT	1.65	34	3.20	83	2.65		
6SR7	1.80	7H7/TV	2.40	12SK7	1.65	35/51	2.00	83V	3.20		
6SR7GT	1.80	7J7	2.65	12SK7GT	1.65	35A5	1.80	84/6Z4	1.80		
6SS7	1.80	7K7	2.65	12SL7GT	2.40	35B5	2.00	85	2.20		
6ST7	2.65	7L7	2.20	12SN7GT	2.20	35C5	2.00	89	2.20		
6T7G	3.20	7N7	2.20	12SQ7	1.50	35L6GT	1.65	99	3.20		
6T8	3.55	7N7/TV	2.65	12SQ7GT	1.50	35W4	1.25	117L7/M7GT	3.90		
6U5/6G5	2.00	7Q7	1.80	12SR7	2.20	35Y4	1.80	117N7GT	3.90		
6U6GT	2.00	7R7	2.20	12Z3	2.65	35Z3	1.80	117P7GT	3.90		
6U7G	1.80	7S7	2.65	14A4	2.65	35Z4GT	1.50	117Z3	1.50		
6V6	3.20	7V7	2.65	14A5	3.90	35Z5GT	1.25	117Z4GT	2.90		
6V6GT	2.00	7W7	2.65	14A7/12B7	2.20	36	2.65	117Z6GT	2.40		
6W4GT	1.80	7X7/XXFM	2.65	14AF7/XXD	2.20	37	1.80	FM1000	3.20		
6X4	1.50	7Y4	1.80	14B6	2.20	38	2.20	<p style="text-align: center;">SPECIAL PURPOSE TUBES</p> <p>2E24</p> <p>2E26</p> <p>2E30</p> <p>2X2/879</p> <p>3A4</p> <p>5R4GY</p> <p>4-125A</p> <p>807</p> <p>829B</p> <p>886A/866</p> <p>9003</p> <p>HY1269</p> <p>VR-150</p>			
6X5	2.20	7Z4	1.80	14B8	2.20	39/44	2.65			2E24	\$5.70
6X5GT	1.50	7Z4/TV	2.20	14C5	2.20	40Z5/45Z5GT	1.80			2E26	3.85
6Y6G	2.40	10	3.90	14C7	2.20	41	1.65			2E30	2.45
6Z7G	3.90	12A6	2.90	14E7	2.20	42	1.65			2X2/879	2.05
6ZY5G	2.20	12A7	3.20	14F7	2.20	43	1.65			3A4	1.20
7A4/XXL	1.80	12A8GT	2.00	14F8	2.65	45	1.65			5R4GY	1.50
7A5	1.80	12AH7GT	2.65	14H7	2.20	46	2.65			4-125A	32.00
7A6	1.80	12AL5	2.00	14H7	2.20	47	2.40			807	2.50
7A7	1.80	12AT6	1.50	14J7	2.65	49	2.65			829B	16.25
7A8	1.80	12AT7	2.90	14Q7	2.20	50	3.90			886A/866	1.95
7AD7	2.65	12AU6	2.00	14R7	2.20	50A5	2.20			9003	3.10
7AF7	1.80	12AU7	2.40	14S7	2.65	50B5	2.00	HY1269	5.50		
7AG7	2.20	12AV6	1.50	14W7	2.65	50C5	2.00	VR-150	1.30		
7AH7	2.20	12AW6	2.65	14X7	2.65	50C6G	2.90	<p style="text-align: center;">TELEVISION PICTURE TUBES</p> <p>2AP1A</p> <p>7JP4</p> <p>10BP4</p> <p>12LP4</p> <p>TP400A</p>			
7B4	1.80	12BA6	1.80	14Y4	2.20	50L6GT	1.65			2AP1A	\$10.55
7B4/TV	2.20	12BD6	1.65	19	3.20	50X6	2.20			7JP4	27.60
7B5	1.80	12BE6	1.80	19T8	3.55	50Y6GT	1.80			10BP4	44.50
7B5/TV	2.20	12C8	3.20	24A	2.20	50Y7GT	2.00			12LP4	75.00
7B6	1.80	12F5GT	1.80	25A6G	2.65	55	2.20			TP400A	60.75
7B7	1.80	12H6	1.80	25AC5GT	2.90	56	1.80				
7B8	1.80	12J5GT	1.50	25C8G	2.90	57	2.00				
7C4/1203	2.65	12J7GT	2.00	25L6	3.20	58	2.00				
7C5	1.80	12K7GT	1.65	25L6GT	1.65	59	3.55				
7C5/TV	2.20	12K8GT	2.40	25Y5	2.90	70L7GT	3.90				



TUBE COMPLEMENTS OF LATE PHILCO RADIOS

MODEL NO.	TUBE TYPES	MODEL NO.	TUBE TYPES
HOME RADIO			
46-131 (121)	1LA6, 1LN5, 1LH4, 1A5GT	46-1203 (121)	7A8, 7C7, 7B7, 7C6, 35L6GT, 50Y6GT
46-131 (122)	1LA6, 1LN5, 1LH4, 1A5GT	46-1203 (122)	7C7, 7A8, 7B7, 7C6, 35L6GT, 50Y6GT
46-132	1A5GT (2), 1LA6, 1LH4, 1LN5	46-1203 (125)	7C7, 7A8, 7B7, 7C6, 35L6GT, 50X6
46-142	1LA6, 1LN5, 1LH4, 1AGT/G (2)	46-1203 (126)	7C7, 7A8, 14A7, 7C6, 35L6GT, 50X6
46-200 (121)	7A8, 7B7, 7C6, 50L6GT, 35Z5GT	46-1209	7F8, 7H7 (2), 7X7, 7AF7, 6V6GT (2), 5Y3GT
46-200 (122)	7A8, 7C6, 7B7, 35Z5GT, 50L6GT	46-1209 (122)	7AF7 (2), 7H7 (2), 7C6, 6V6GT (2), 5Y3GT
46-200 (125)	7A8, 14A7, 14B6, 50L6GT, 35Y4	46-1210	7F8, 7H7 (2), 7X7, 7AF7, 6V6GT (2), 5Y3GT
46-250 (121)	7A8, 7C6, 7B7, 35Z5GT, 50L6GT	46-1213	7W7, 7F8, 7H7 (2), 7B7, FM1000, 6SQ7GT, 7AF7, 6V6GT (2), 5U4G
46-250 (122)	7A8, 7C6, 7B7, 35Z5GT, 50L6GT	46-1214	7W7, 5U4G, 6L6GT (2), FM1000, 6J5GT (3), 7E6, 7F8, 7H7 (2), 7B7, 7E5/1201
46-250 (125)	7A8, 7C6, 7B7, 50B5, 35Y4	46-1226 (121)	7F8, 7H7 (2), 7C6, 6J5GT, 6K6GT (2), 5Y3GT
46-250 (126)	7A8, 14A7, 14B6, 50B5, 35Y4	46-1226 (122)	7AF7, 7H7 (2), 7C6, 6J5GT, 6K6GT (2), 5Y3GT
46-420 (121)	7C7, 7A8, 7B7, 7C6, 50B5, 35Z5GT	46-1226 (125)	7AF7, 7H7 (2), 7C6, 6J5GT, 6K6GT (2), 5Y3GT
46-420 (125)	7C7, 7A8, 7B7, 7C6, 50L6GT, 35Z5GT	47-204 (122)	7A8, 7C6, 7B7, 35Z5GT, 50L6GT
46-420 (128)	7C7, 7A8, 7B7, 7C6, 50B5, 35Y4	47-204 (125)	7A8, 14B6, 14A7, 35Y4, 50L6GT
46-421	7A8, 7C6, 7B7, 35Z5GT, 7C7, 50L6GT	47-205 (122)	7A8, 7C6, 7B7, 35Z5GT, 50L6GT
46-427	7C6, 7B7 (2), 35Z5GT, 50L6GT, 14AF7/XXD	47-205 (125)	7A8, 14B6, 14A7, 35Y4, 50L6GT
46-431	7AF7, 7H7 (2), 7C6, 6K6GT, 6X5GT	47-1227	5AZ4, 7R7, 7X7, 6J5GT, 6K6GT (2), 6BA6, 6AG5, 7F8
46-432	14H7, 14X7, 50A5, 117Z3	47-1230	7R7, 7X7, 6V6GT (2), 5Y3GT, 7AF7, 6BA6, 6AG5, 7F8
46-451	7AF7, 7H7 (2), 6H6GT, 6K6GT, 6X5GT	48-141	3LF4, 1LA6, 1LH4, 1LN5
46-454	7W7, 7F8, 7H7 (2), 7B7, FM1000, 5Y3GT, 6SQ7GT, 6V6GT	48-145	3LF4, 1LA6, 1LH4, 1LN5
46-480	7F8, 7H7 (2), 6H6GT, 6SQ7GT, 6V6GT, 7Z4	48-150	3LF4, 1LA6, 1LH4, 1LN5, 1LG5
46-1201 (121)	7A8, 7B7, 7C6, 35L6GT, 50Y6GT	48-200 (121)	7A8, 14B6, 14A7, 35Z5GT, 50A5
46-1201 (122)	7A8, 7B7, 7C6, 50A5, 35Y4	48-200 (125)	7A8, 14B6, 14A7, 35Y4, 50L6GT
46-1201 (125)	7A8, 7B7, 7C6, 35L6GT, 50Y6GT	48-206 (121)	7A8, 14B6, 14A7, 35Z5GT, 50A5
46-1201 (126)	7A8, 7B7, 7C6, 35L6GT, 50X6	48-206 (125)	7A8, 14B6, 14A7, 35Y4, 50L6GT
46-1201 (127)	7A8, 7B7, 7C6, 50A5, 50Y6GT	48-214 (121)	7A8, 14B6, 14A7, 35Z5GT, 50A5
46-1201 (128)	7A8, 7B7, 7C6, 50A5, 50X6	48-214 (125)	7A8, 14B6, 14A7, 35Y4, 50L6GT
46-1201 (130)	7A8, 7B7, 7C6, 50B5, 50X6		



TUBE COMPLEMENTS OF LATE PHILCO RADIOS (Cont.)

MODEL NO.	TUBE TYPES	MODEL NO.	TUBE TYPES
HOME RADIO (Cont.)		48-1270	7H7, 7F7, 7B7, 7E7, FM1000, 6SQ7GT, 6V6GT (2), 5U4G, 7AF7, 7W7, 7F8, 7H7
48-225	7A8, 14B6, 14A7, 35Z5GT, 50A5	48-1274	6AU6, 5U4G, 6L6GA (2), FM1000, 6J5GT (3), 7E6, 7R7, 7F8, 7F7, 7H7 (2), 7B7, 7E5/1201
48-230	7A8, 14B6, 14A7, 35Z5GT, 50A5	48-1276	6AU6, 5U4G, 6L6GA (2), FM1000, 6J5GT (3), 7E6, 7F8, 7H7 (2), 7B7, 7E5/1201
48-250 (121)	7A8, 14B6, 14A7, 35Z5GT, 50A5	48-1282	14AF7, 7B7 (2), 7C6, 35L6GT, 50X6
48-250 (126)	7A8, 14B6, 14A7, 35Y4, 50B5	48-1283	14AF7, 7B7 (2), 7C6, 35L6GT, 50X6
48-460	14AF7/XXD, 7C6, 7B7 (2), 35Y4, 50L6GT	48-1284	7Z4, 6K6GT (2), 7F7, 7AF7, 7R7, 7A7
48-461	14AF7/XXD, 7C6, 7B7 (2), 35Y4, 50A5	48-1286	5AZ4, 7R7, 7F7, 7X7, 7E7, 6J5GT, 6K6GT (2), 6BA6, 6AU6, 7F8
48-464	7C6, 7B7 (2), 35Y4, 50A5, 14AF7/XXD	48-1290	6BA6 (2), 7F7, 7A7, 7E7, FM1000, 6SQ7GT (2), 6V6GT (2), 5U4G, 7AF7, 6AU6, 7F8
48-472 (121)	14H7, 14X7, 50A5, 117Z3, 12AW6, 14H7, 14F8	49-100	1LA6, 1LN5, 1LH4, 3LF4
48-472 (122)	6BJ6 (2), 19T8, 50A5, 117Z3, 12AU6, 12AU7, 14F8	49-500	7A8, 14A7, 14B6, 50A5, 35Z5GT
48-475	6BA6 (2), 6H6GT, 7C6, 7B5, 7Z4, 7F8, 6AG5	49-501	7A8, 14A7, 14B6, 50A5, 35Y4
48-482	7H7, 7B7, FM1000, 6SQ7GT, 5Y3GT, 6V6GT, 7W7, 7F8, 7H7	49-503	7A8, 14B6, 14A7, 50A5, 35Z5GT
48-485	14AF7, 7B7 (2), 7C6, 35L6GT, 50X6	49-504	7A8, 14A7, 14B6, 50A5, 35Z5GT
48-1200	14B6, 50L6GT	49-505	7A8, 14A7, 14B6, 50A5, 35Y4
48-1201 (121)	7A8, 7B7, 7C6, 50A5, 50X6	49-506	7A8, 14A7, 14B6, 50A5, 35Z5GT
48-1201 (122)	7A8, 7B7, 7C6, 50L6GT, 50Y6GT	49-603	12BE6, 12BA6, 12AT6, 50B5, 35W4
48-1253	7A8, 7B7, 7C6, 50X6, 50A5	49-900	14AF7, 7B7 (2), 7C6, 50L6GT, 35Y4
48-1256	7C7, 7A8, 14A7, 7C6, 35L6GT, 50Y6GT	49-901	7A8, 14A7, 14B6, 50A5, 35Y4
48-1260	7A8, 7B7, 7C6, 50A5, 50X6	49-902	12AU6, 14AF7, 14B6, 12BA6, 35Y4, 35A5
48-1262	14AF7, 7B7 (2), 7C6, 35L6GT, 50X6	49-904	14AF7, 12BA6, 12AU6, 14B6, 35A5, 35Y4
48-1263	5Y3GT, 7A7, 7AF7, 7C6, 6J5GT, 6K6GT (2)	49-905	35W4, 35CS, 12AU6, 12AT7, 19T8, 6BH6
48-1264 (121)	5AZ4, 7R7, 7X7, 6J5GT, 6K6GT (2)	49-906	12AU6, 12AU7, 14F8, 6BJ6 (2), 19T8, 50A5, 117Z3
48-1264 (122)	5AZ4, 7R7, 7X7, 6J5GT, 6BA6, 6AU6, 7F8	49-909	12AU6, 12AU7, 14F8, 6BJ6 (2), 19T8, 50L6GT, 117Z3 (2)
48-1266 (121)	7R7, 7X7, 6V6GT (2), 5AZ4, 7A4, 6BA6, 6AG5, 7F8		
48-1266 (122)	7R7, 7X7, 6V6GT (2), 5AZ4, 7A4, 6BA6, 6AU6, 7F8		



TUBE COMPLEMENTS OF LATE PHILCO RADIOS (Cont.)

MODEL NO.	TUBE TYPES	MODEL NO.	TUBE TYPES
HOME RADIO (Cont.)			
49-1100	14AF7, 7B7 (2), 7C6, 35L6GT, 50X6	S4627	7Y4, 7B6, 7B8, 7A7 (2), 7A4, 7C5 (2)
49-1101	12AU6, 12AU7, 14F8, 6BJ6 (2), 19T8, 50L6GT, 117Z3 (2)	P4735	7Y4, 7B6, 7B8, 7A7, 7A4, 7C5 (2)
49-1401	12BE6, 12BA6, 6AQ6, 35L6GT, 50Y6GT	S4824	7A5, 7B6, 7B8, 7A7 (2), 7Y4
49-1404	12BE6, 12BA6, 6AQ6, 35L6GT, 50Y7GT	UN6-100	7B8, 7Y4, 7A5, 7B6, 7A7 (2)
49-1405	12BE6, 12BA6, 6AQ6, 35L6GT, 50Y7GT	UN6-400	7B8, 7Y4, 7B6, 7A7 (2), 7C5
49-1600	14Q7, 12BA6, 7C6, 35L6GT, 50X6	UN6-450	7Y4, 7B6, 7B8, 7A7 (2), 7C5
49-1602	7B7 (2), 7C6, 14AF7, 35L6GT, 50X6	UN6-500	7Y4, 7B6, 7B8, 7A7 (2), 7C5
49-1603	7B7 (2), 7C6, 14AF7, 35L6GT, 50X6	UN6-550	7Y4, 7B6, 7B8, 7A7 (2), 7C5
49-1604	7B7 (2), 7C6, 14AF7, 35L6GT, 50X6	CR2	7B8, 7Y4, 7A5, 7B6, 7A7 (2)
49-1605	7B7 (2), 7C6, 14AF7, 35L6GT, 50X6	CR4	6BA6 (2), 6AV6, 7C5, 6X4, 6BE6
49-1606	12AU6, 12AU7, 14F8, 6BJ6 (2), 19T8, 50C6G	CR6	6BA6 (2), 6AV6, 7C5, 6X4, 6BE6
49-1607	12AU6, 12AU7, 14F8, 6BJ6 (2), 19T8, 50C6G	CR8	6BA6 (2), 6AV6, 7C5, 6X4, 6BE6
49-1609	12AU6, 12AU7, 14F8, 6BJ6 (2), 19T8, 50C6	CR9	6BA6 (2), 6BE6, 6AV6, 6AQ5, 6X4
49-1611	12AU6, 12AU7, 14F8, 6BJ6 (2), 19T8, 50C6	CR10	6BA6 (2), 6AV6, 7C5, 6X4, 6BE6
49-1613	6AU6, 7F8, 6BA6, 7R7, 7X7, 6J5GT, 6K6GT (2), 7 7, 7F7, 5AZ4	CR12	6BA6 (2), 6AV6, 6C4, 7C5 (2), 6X4
AUTO RADIO		PORTABLES	
C4608	7Y4, 7B6, 7B8, 7A7 (2), 7A4, 7C5 (2)	46-350 (121)	1T4 (2), 1R5, 1U5, 3Q5GT, 117Z3
P4635	7Y4, 7B6, 7B8, 7A7 (2), 7A4, 7C5 (2)	46-350 (122)	1T4 (2), 1R5, 1U5, 3LF4, 117Z3
P4636	7Y4, 7B6, 7B8, 7A7 (2), 7C5	46-350 (125)	1T4 (2), 1R5, 1U5, 3Q5GT, 117Z3
S4624	7A5, 7B6, 7B8, 7A7 (2), 7Y4	48-300	1R5, 1T4, 1U5, 3V4, 117Z3
S4625	7A5, 7B6, 7B8, 7A7 (2), 7Y4	48-360	1T4 (2), 1R5, 1U5, 3LF4, 117Z3
S4626	7Y4, 7B6, 7B8, 7A7 (2), 7A4, 7C5 (2)	49-601	3V4, 1T4, 1U5, 1R5
		49-602	3V4, 1T4, 1U5, 1R5
		49-605	1T4 (2), 1R5, 1U5, 3LF4, 117Z3
		49-607	1T4 (2), 1R5, 1U5, 3LF4, 117Z3



TUBE COMPLEMENTS OF LATE PHILCO RADIOS (Cont.)

MODEL NO.	TUBE TYPES	MODEL NO.	TUBE TYPES
TELEVISION RECEIVERS			
48-700	7JP4, 6AG5 (6), 7W7 (2), 7B4, 7B5 (2), 6AL5 (2), 7F8, 6SL7GT (2), 7C5 (5), 5U4G, 1B3GT, 6J6	49-1076	6AT6, 12AU7 (2), 6K6GT (2), 7N7 (2), 7F7 (2), 5U4G, 7Z4, 6AG5 (5), 6BA6 (2), 6AL5 (2), 6BG6G, 5V4G, 1B3GT, 19T8, 6BJ6, 50C6G, 6J6, 12AU6, 10BP4, 14F8
48-1000 (121)	10BP4, 6AG5 (6), 7W7 (2), 7B4, 6AL5 (2), 7B6, 7C5, 6K6GT, 7F8, 6SL7GT (2), 6BG6G, 6AS7G, 5U4G (2), 1B3GT, 6J6	49-1240	7Z4, 7N7 (2), 7F7 (2), 1B3GT (2), 6BG6G, 6K6GT (2), 5V4G, 5U4G, 6AG5 (5), 12AU7 (2), 6AL5 (2), 6J6, 6BA6 (2), 6AT6, 12LP4, 14F8, 50C6G, 6BJ6 (2), 12AU6, 19T8
48-1000 (122)	10BP4, 6AG5 (6), 7H7 (2), 7B4, 6AL5 (2), 6AT6, 7B6, 7C5, 6K6GT, 7F8, 6SL7GT (2), 6BG6-G, 5V4G, 7B5 (2), 5U4G (2), 1B3GT, 6J5	49-1275	7Z4, 7N7 (2), 7F7 (2), 1B3GT, 6BG6G, 6K6GT (2), 5V4G, 5U4G, 6AG5 (5), 12AU7 (2), 6AL5 (2), 6J6, 6BA6 (2), 6AT6, 12LP4, 14F8, 50C6G, 6BJ6 (2), 12AU6, 19T8
48-1000 (125)	10BP4, 6AG5 (6), 7W7 (2), 7B4, 6AL5 (2), 7B6, 7C5, 6K6GT, 7F8, 6SL7GT (2), 6BG6G, 6AS7G, 7B5 (2), 5U4G (2), 1B3GT, 6J6	49-1278	12LP4, 6AT6, 6K6GT (2), 7N7 (2), 7F7 (2), 6BG6G, 5U4G, 5V4G, 7Z4, 6AG5 (3), 6BA6 (2), 6AL5 (2), 1B3GT, 50C6, 19T8, 12AU6, 14F8, 6BJ6 (2), 12AU7 (2)
48-1001	6J6, 6AG5 (6), 5U4G (2), 1B3GT, 7H7 (2), 6AL5, 7B4, 7B5 (2), 6AL5 (2), 7B6, 7C5, 6AT6, 7F8, 6SL7GT (2), 6K6GT, 6BG6G, 5V4G, 10BP4	TEST EQUIPMENT	
48-1050 (122)	10BP4, 6AG5 (6), 7H7 (2), 7B4, 6AL5 (2), 6AT6, 7B6, 7C5, 6K6GT, 7F8, 6SL7GT (2), 6BG6G, 5V4G, 7B5 (2), 5U4G (2), 1B3GT, 6J6	5072	12AU7 (4)
48-2500 (121)	6AG5 (6), 7W7 (2), 7B4, 6AL5 (3), 7B6, 7AD7, 7F8, 6SL7GT (2), 6BG6G, 6AS7G, 7B5 (2), 6V6GT, 5U4G (2), 1B3GT (3), 6J6, TP400A	7001	6AL5, 7Y4, 7B5, 6SN7GT
48-2500 (122)	6AG5 (6), 7W7 (2), 7B4, 6AL5 (3), 7B6, 7AD7, 7F8, 6SL7GT (2), 6BG6-G, 6AS7, 7B5 (2), 6V6GT, 5U4G (2), 1B3GT (3), 6J6, TP400A	7008	5Z4, 6X4 (2), 6AK5 (2), 6C4 (4), 6J6, 7F7 (2), 3MPI
49-1075	6AT6, 12AU7 (2), 6K6GT (2), 7N7 (2), 7F7 (2), 5U4G, 7Z4, 6AG5 (5), 6BA6 (2), 6AL5 (2), 6BG6G, 5V4G, 1B3GT, 19T8, 6BJ6, 50C6G, 6J6, 12AU6, 10BP4, 14F8	7019	6AU6, 6J6, 6X4, 2AP1A
		7030	6AQ6, 7Y4, 7A5, 7L7
		7050A	6X5GT
		7070	6C4, 7F8, 6X5GT
		7170	6C4, 7F8 (2), 6X5GT

MINIATURE LAMPS

The Philco line of miniature lamps is designed for general use and for replacement purposes. The line includes: Panel Lamps; Flashlight Lamps; Neon Lamps; Photo-Electric Pickup Lamps; Intermediate Lamps.

Precision-made under the Philco system of quality control, these lamps will give long service, uniform light, and trouble-free operation.

A replacement lamp should have the same type number as the original. If for any reason the type number is unknown, the correct Philco lamp can be selected by use of the voltage and current data listed in the chart below.

	PART NO.	TYPE	FIG.	VOLTS	WATTS	AMPS	BEAD COLOR	LIST PRICE
PANEL LAMPS								
BAYONET BASE	CYLINDRICAL	34-2065	49	A	2	.06	Pink	\$0.15
		34-2221	43	A	2.5	.5	White	.09
		34-2064	44	A	6-8	.25 at 6.3v	Blue	.09
		34-2068	47	A	6-8	.15 at 6.3v	Brown	.09
		34-2397		A	12-16	.10 at 15v	White	.30
ROUND	34-2039	55	B	6-8	.4 at 6.5v	White	.09	
	34-2040	51	B	6-8	.2 at 7.5v	White	.09	
SCREW BASE	CYLINDRICAL	5316	48	C	2	.06	Pink	.15
		3463	41	C	2.5	.5	White	.09
		4567	40	C	6-8	.15 at 6.3v	Brown	.09
		6608	46	C	6-8	.25 at 6.3v	Blue	.09
	ROUND	34-2246	123	D	1.25	.300	Pink	.09
FLASHLIGHT LAMPS								
PENLIGHT TYPE		45-2836	222	E	2.2	For all two-cell penlights		.09
SCREW BASE, ROUND	45-2827	14	D	2.5	For all two-cell flashlights		.09	
	45-2828	13	D	3.8	For all three-cell flashlights		.09	
	45-6385	PR2	D	2.4	For 45-1517 and 45-1518 flashlights		.13	
PHOTOELECTRIC PICKUP LAMPS								
BAYONET BASE		34-2478		F	3-3.5	.6 at 3.3v	Green	.45
NEON LAMPS								
SCREW BASE	34-2482		G	105-125	¼			1.00
	34-2483		G	75	¼			1.00
BAYONET BASE	34-2432		H	105-125	¼			.35
	34-2493		H	Special for 1942 Home Record Kit				.25
INTERMEDIATE LAMPS								
SCREW BASE	34-2484		I	110-125	10			.15
	34-2605		I	110-125	7			.15

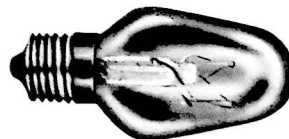



BALLAST TUBES FOR UNIVERSAL REPLACEMENT

The Philco Ballast Tube is a metal, tube-type line-voltage dropping resistor, designed to supply the necessary voltages for tube filaments and pilot lamps in a-c/d-c radio sets operating from a 117-volt power source. Because of the superior construction of its resistance element, it will keep the current in the circuit practically constant under varying line-voltage conditions. The Philco Ballast Tube will operate the tube filaments in a series circuit well within their current rating, even though the pilot lamp may burn out.

LIST PRICE

\$1.00

The ten Philco Ballast Tubes listed below replace more than 875 special ballast tubes in all makes of radios.

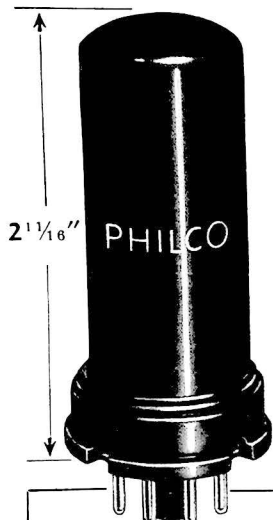

RECOMMENDED PHILCO REPLACEMENTS FOR UNCODED BALLAST TUBES

A replacement for an uncoded ballast tube, or for a ballast tube on which the coding cannot be identified, can be determined by adding the total voltage drops of the tubes used in series, and subtracting the sum of these voltage drops from the line voltage (117 volts); the result will be the necessary voltage-dropping requirements for the tube.

AN EXAMPLE IS SHOWN AT THE RIGHT

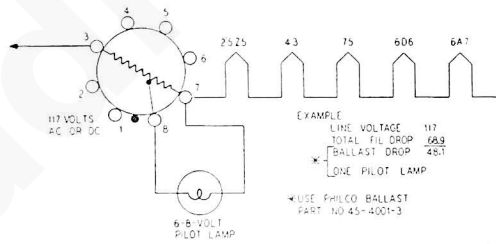

RECOMMENDED PHILCO REPLACEMENTS FOR CODED BALLAST TUBES

Ten Philco Ballast Tubes Replace Over 875 Special Types

NOTE: The socket-wiring connections should be checked before making a Philco Ballast Tube replacement, as unused socket lugs are sometimes employed by radio-set manufacturers for mountings or tie-points not associated with the ballast-tube circuit. If the socket lugs are used for this purpose, the base pins which are not used should be cut off.

USE PHILCO BALLAST TUBE NO.	RMA DESCRIPTION	REPLACES BALLAST TUBES WITH PREFIX	REPLACES BALLAST TUBES WITH SUFFIX	REPLACES BALLAST TUBES WITH VOLTAGE DROP
45-4001	10-23-A	BK, BL, K, L, M	A, B, C, D	10 to 23
45-4001-1	10-23-E	BK, BL, K, L, M	E	10 to 23
45-4001-2	10-23-F	BK, BL, K, L, M	F, G, H	10 to 23
45-4001-3	23-55-A	BK, BL, K, L, M	A, B, C, D	23 to 55
45-4001-4	23-55-E	BK, BL, K, L, M	E	23 to 55
45-4001-5	23-55-F	BK, BL, K, L, M	F, G, H	23 to 55
45-4001-6	60-92-A	BK, BL, K, L, M	A, B, C, D	60 to 92
45-4001-7	60-92-E	BK, BL, K, L, M	E	60 to 92
45-4001-8	60-92-F	BK, BL, K, L, M	F, G, H	60 to 92
45-4001-9	92-105-A	BK, BL, K, L, M	A, B, C, D	92 to 105

STANDARD INTERNAL WIRING DIAGRAMS (Bottom View of Tube or Socket)

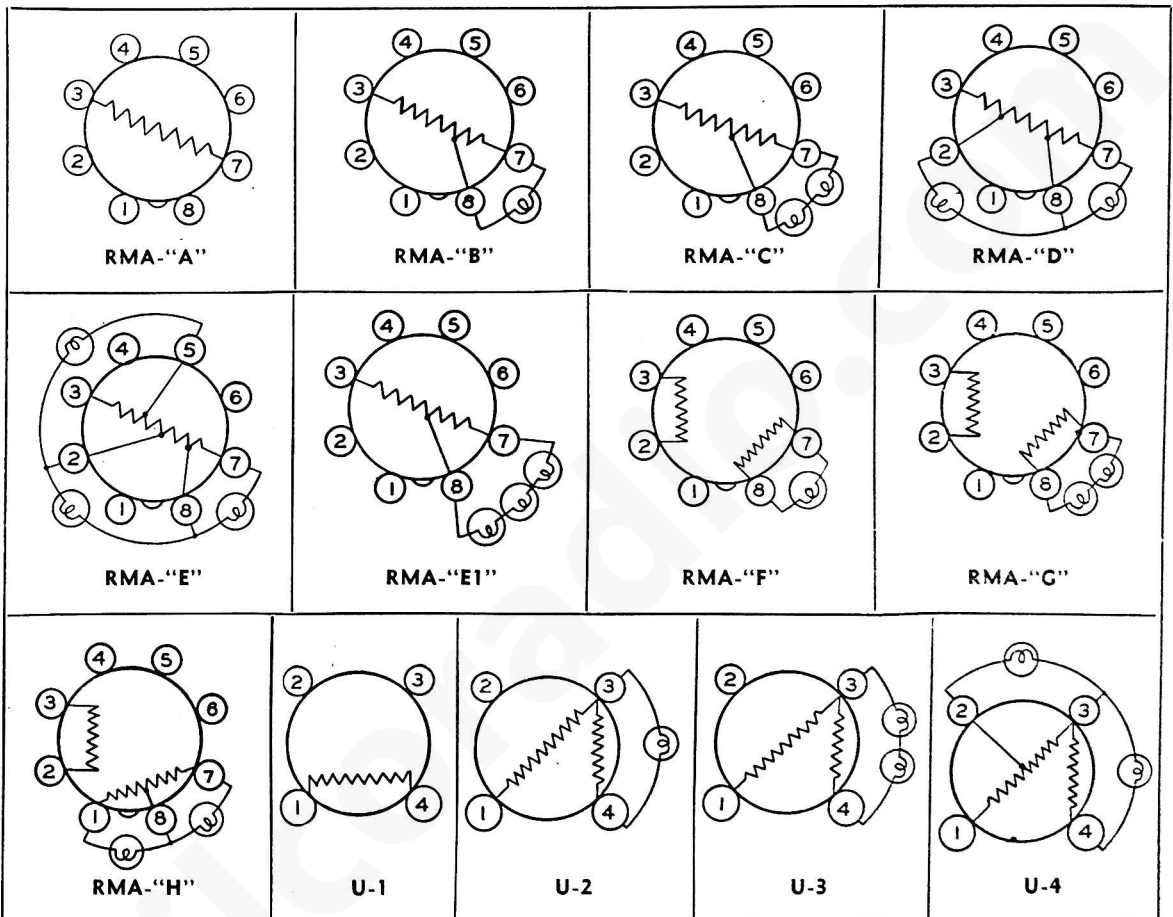

R. M. A. SYSTEM OF CODING BALLAST TUBES

One prefix letter, "K", "L" or "M", is used to indicate the type of pilot lamp, 150 ma., 250 ma., or 200 ma. respectively, at 6—8 volts. If the letter "B" precedes this letter, the pilot-lamp section of the resistor element has ballast action.

The number which follows the prefix letter indicates the voltage drop across the resistor element, including the pilot-lamp section.

The suffix letter which follows the number indicates the R. M. A. circuit wiring of the ballast tube, as shown in the diagrams above. If the ballast tube has a glass envelope, the letter "G" is added.

To replace the "U" type with a Philco universal ballast, an adapter or an octal socket must be installed in the place of the standard socket.

NOTE: A four-pin ballast tube is indicated by the letter "X" between the pilot-lamp letter and the voltage-drop number. The letter "J" following any suffix letter indicates that two pins of the tube are internally shorted with a jumper. When replacing a ballast tube having an internal jumper, check the tube to determine where the jumper is connected, then short externally the same two pins on the Philco Ballast Tube.



BALLAST REPLACEMENT CHART

The ten Philco ballast tubes listed on the two preceding pages replace over 875 special ballast tubes made by many manufacturers.

On this and the following pages are listed the various types of ballasts and the proper Philco replacement.

*Means the ballast has a "UX" base. Use adapter or change to octal socket.

**Indicates a letter "J" following any of the suffixes. Letter "J" means two pins of the tube are shorted internally with a jumper. Check the defective ballast to determine where the jumper is connected, then short externally the same two pins of the Philco ballast.

For rewiring "UX" sockets, refer to base diagrams on preceding page.

To Replace Ballast No.	Use Philco Ballast	† Original UX Socket Wiring Diagram	† Rewire to Conform to Diagram	To Replace Ballast No.	Use Philco Ballast	† Original UX Socket Wiring Diagram	† Rewire to Conform to Diagram
NUMERICAL TYPE							
2UR	45-4001-3			55MC	45-4001-3		
2VR	45-4001-3			60R30*	45-4001-3	U-2	RMA-B
3CR	45-4001-3			60R30G*	45-4001-3	U-2	RMA-B
3ER	45-4001-3			61A	45-4001-6		
5B*	45-4001-3	U-2	RMA-B	61KB	45-4001-6		
6B*	45-4001-3	U-3	RMA-C	61KC	45-4001-6		
6.125	45-4001-3			61MB	45-4001-6		
6.125	45-4001-3			61MC	45-4001-6		
6.129	45-4001-3			62A	45-4001-6		
6.133	45-4001-3			67A	45-4001-6		
6.133A	45-4001-3			67KB	45-4001-6		
6.135	45-4001-3			67KC	45-4001-6		
10A	45-4001			67KD	45-4001-6		
11AJ	45-4001 **			74A	45-4001-6		
17A	45-4001			74KA	45-4001-6		
17AJ	45-4001 **			74KB	45-4001-6		
30AG	45-4001-3			74KC	45-4001-6		
30AJ	45-4001-3**			74KD	45-4001-6		
30LB	45-4001-3			79A	45-4001-6		
30LC	45-4001-3			79KB	45-4001-6		
30LD	45-4001-3			79KC	45-4001-6		
32	45-4001-5			80A	45-4001-6		
36A	45-4001-3			82A	45-4001-6		
36AG	45-4001-3			82LB	45-4001-6		
36H	45-4001-5			85R8*	45-4001	U-3	RMA-C
37A	45-4001-3			86A	45-4001-6		
40*	45-4001-3	U-1	RMA-A	88A	45-4001-6		
40A2*	45-4001-3	U-3	RMA-C	90R8*	45-4001	U-3	RMA-C
42A (Octal)	45-4001-3			92A	45-4001-6		
42A (UX)*	45-4001-3	U-1	RMA-A	94R8*	45-4001	U-3	RMA-C
42AG	45-4001-3			95K2	45-4001-3		
42HA	45-4001-5			100.37	45-4001-3		
45W*	45-4001-3	U-1	RMA-A	100.38	45-4001-3		
49B	45-4001-3			100.45	45-4001-3		
49C	45-4001-3			100.70	45-4001-3		
49H	45-4001-5			100R*	45-4001-3	U-1	RMA-A
49W	45-4001-3			100R4*	45-4001-3	U-2	RMA-B
50*	45-4001-3	U-1	RMA-A	100R8*	45-4001-3	U-3	RMA-C
50A2*	45-4001-3	U-3	RMA-C	115.22	45-4001-3		
50B2*	45-4001-3	U-2	RMA-B	115.28	45-4001-3		
50W*	45-4001-3	U-1	RMA-A	115.40	45-4001-3		
50X3	45-4001-3	U-1	RMA-A	115.41	45-4001-3		
50X300*	45-4001-3	U-1	RMA-A	115.42	45-4001-3		
50X3T	45-4001-3	U-3	RMA-C	115.53	45-4001-3		
52H	45-4001-5			115.53X	45-4001-3		
55A	45-4001-3			115.55	45-4001-3		
55KA	45-4001-3			115.65	45-4001-3		
55KB	45-4001-3			120R8*	45-4001-3	U-3	RMA-C
55KC	45-4001-3			135K1	45-4001-3		
55LB	45-4001-3			135K1A	45-4001-3		
55LC	45-4001-3			140A*	45-4001-3	U-1	RMA-A
55MB	45-4001-3			140KB (Octal)	45-4001-3		



BALLAST REPLACEMENT CHART (Cont.)

To Replace Ballast No.	Use Philco Ballast	† Original UX Socket Wiring Diagram	† Rewire to Conform to Diagram	To Replace Ballast No.	Use Philco Ballast	† Original UX Socket Wiring Diagram	† Rewire to Conform to Diagram
NUMERICAL TYPE (Cont.)							
140KB (UX)*	45-4001-3	U-2	RMA-B	185LB (Octal)	45-4001-3	U-2	RMA-B
140KC (Octal)	45-4001-3			185LB (UX)*	45-4001-3		
140KC (UX)*	45-4001-3	U-2	RMA-B	185LC (Octal)	45-4001-3		
140L4*	45-4001-3	U-2	RMA-B	185LC (UX)*	45-4001-3	U-3	RMA-C
140L8*	45-4001-3	U-3	RMA-C	185LD (Octal)	45-4001-3		
140L44*	45-4001-3	U-4	RMA-D	185LD (UX)*	45-4001-3		
140LB (Octal)	45-4001-3	U-2	RMA-B	185M4*	45-4001-3	U-2	RMA-B
140LB (UX)*	45-4001-3			185M8*	45-4001-3	U-3	RMA-C
140LC (Octal)	45-4001-3	U-3	RMA-C	185R*	45-4001-3	U-1	RMA-A
140LC (UX)*	45-4001-3			185R4*	45-4001-3	U-2	RMA-B
140LD (Octal)	45-4001-3	U-4	RMA-D	185R8*	45-4001-3	U-3	RMA-C
140LD (UX)*	45-4001-3			185R44*	45-4001-3	U-4	RMA-D
140M4*	45-4001-3	U-2	RMA-B	190K1	45-4001-6		
140M8*	45-4001-3	U-3	RMA-C	200R*	45-4001-6	U-1	RMA-A
140R*	45-4001-3	U-1	RMA-A	200R4*	45-4001-6	U-2	RMA-B
140R4*	45-4001-3	U-2	RMA-B	200R8*	45-4001-6	U-3	RMA-C
140R8*	45-4001-3	U-3	RMA-C	245A	45-4001-6	U-1	RMA-A
140R44*	45-4001-3	U-4	RMA-D	245KB (Octal)	45-4001-6		
160R4*	45-4001-3	U-2	RMA-B	245KB (UX)*	45-4001-6	U-2	RMA-B
165A*	45-4001-3	U-1	RMA-A	245KC (Octal)	45-4001-6		
165KB (Octal)	45-4001-3			245KC (UX)*	45-4001-6	U-3	RMA-C
165KB (UX)*	45-4001-3	U-2	RMA-B	250A*	45-4001-6	U-1	RMA-A
165KC (Octal)	45-4001-3			250KB (Octal)	45-4001-6		
165KC (UX)*	45-4001-3	U-3	RMA-C	250KB (UX)*	45-4001-6	U-2	RMA-B
165KD (Octal)	45-4001-3			250KC (Octal)	45-4001-6		
165KD (UX)*	45-4001-3	U-4	RMA-D	250KC (UX)*	45-4001-6	U-3	RMA-C
165L4*	45-4001-3	U-2	RMA-B	250L4*	45-4001-6	U-2	RMA-B
165L8*	45-4001-3	U-3	RMA-C	250L8*	45-4001-6	U-3	RMA-C
165L44*	45-4001-3	U-4	RMA-D	250M4*	45-4001-6	U-2	RMA-B
165LB (Octal)	45-4001-3			250M8*	45-4001-6	U-3	RMA-C
165LB (UX)*	45-4001-3	U-2	RMA-B	250R*	45-4001-6	U-1	RMA-A
165LC (Octal)	45-4001-3			250R4*	45-4001-6	U-2	RMA-B
165LC (UX)*	45-4001-3	U-3	RMA-C	250R8*	45-4001-6	U-3	RMA-C
165LD (Octal)	45-4001-3			270KB (Octal)	45-4001-6		
165LD (UX)*	45-4001-3	U-4	RMA-D	270KB (UX)*	45-4001-6	U-2	RMA-B
165M4*	45-4001-3	U-2	RMA-B	270KC (Octal)	45-4001-6		
165M8*	45-4001-3	U-3	RMA-C	270KC (UX)*	45-4001-6	U-3	RMA-C
165R*	45-4001-3	U-1	RMA-A	270L4*	45-4001-6	U-2	RMA-B
165R4*	45-4001-3	U-2	RMA-B	270L8*	45-4001-6	U-3	RMA-C
165R8*	45-4001-3	U-3	RMA-C	270M4*	45-4001-6	U-2	RMA-B
165R44*	45-4001-3	U-4	RMA-D	270M8*	45-4001-6	U-3	RMA-C
170K1	45-4001-3			270R*	45-4001-6	U-1	RMA-A
180A*	45-4001-3	U-1	RMA-A	270R8*	45-4001-6	U-3	RMA-C
180KB (Octal)	45-4001-3			340*	45-4001-3	U-1	RMA-A
180KB (UX)*	45-4001-3	U-2	RMA-B	2903	45-4001-3		
180KC (Octal)	45-4001-3			2904	45-4001-3		
180KC (UX)*	45-4001-3	U-3	RMA-C	2905	45-4001-3		
180KD (Octal)	45-4001-3			2906	45-4001-3		
180KD (UX)*	45-4001-3	U-4	RMA-D	2922	45-4001-6		
185A	45-4001-3	U-1	RMA-A	2923	45-4001-6		
185KB (Octal)	45-4001-3			8593	45-4001-3		
185KB (UX)*	45-4001-3	U-2	RMA-B	8598	45-4001-3		
185KC (Octal)	45-4001-3			16032	45-4001-6		
185KC (UX)*	45-4001-3	U-3	RMA-C	16035	45-4001-3		
185KD (Octal)	45-4001-3			16036	45-4001-3		
185KD (UX)*	45-4001-3	U-4	RMA-D	16037	45-4001-1		
185L4*	45-4001-3	U-2	RMA-B	A-16040	45-4001-3		
185L8*	45-4001-3	U-3	RMA-C	81966-2	45-4001-3		
185L44*	45-4001-3	U-4	RMA-D	81996	45-4001-3		
'BK' TYPE							
BK-11-B	45-4001			BK-17-E	45-4001-1		
BK-11-C	45-4001			BK-23-B	45-4001-3		
BK-11-D	45-4001			BK-23-C	45-4001-3		
BK-17-B	45-4001			BK-23-D	45-4001-3		
BK-17-C	45-4001			BK-23-E	45-4001-4		
BK-17-D	45-4001			BK-24-C	45-4001-3		



BALLAST REPLACEMENT CHART (Cont.)

To Replace Ballast No.	Use Philco Ballast	† Original UX Socket Wiring Diagram	† Rewire to Conform to Diagram	To Replace Ballast No.	Use Philco Ballast	† Original UX Socket Wiring Diagram	† Rewire to Conform to Diagram
“BK” TYPE (Cont.)							
BK-29-B	45-4001-3			BK-49-C	45-4001-3		
BK-29-C	45-4001-3			BK-49-CJ	45-4001-3**		
BK-29-D	45-4001-3			BK-49-D	45-4001-3		
BK-30-B	45-4001-3			BK-49-DG	45-4001-3		
BK-30-C	45-4001-3			BK-49-D10	45-4001-3		
BK-30-D	45-4001-3			BK-49-E	45-4001-4		
BK-30-H	45-4001-5			BK-52-H	45-4001-5		
BK-32-D	45-4001-3			BK-55-B	45-4001-3		
BK-36-B	45-4001-3			BK-55-BG	45-4001-3		
BK-36-C	45-4001-3			BK-55-BJ	45-4001-3**		
BK-36-D	45-4001-3			BK-55-C	45-4001-3		
BK-36-E	45-4001-4			BK-55-D	45-4001-3		
BK-36-F	45-4001-5			BK-55-E	45-4001-4		
BK-36-H	45-4001-5			BK-55-F	45-4001-5		
BK-42-B	45-4001-3			BK-61-B	45-4001-6		
BK-42-BG	45-4001-3			BK-61-G	45-4001-6		
BK-42-C	45-4001-3			BK-61-D	45-4001-6		
BK-42-D	45-4001-3			BK-61-E	45-4001-7		
BK-42-DG	45-4001-3			BK-67-B	45-4001-6		
BK-42-E	45-4001-4			BK-67-C	45-4001-6		
BK-49-B	45-4001-3			BK-67-D	45-4001-6		
BK-49-BG	45-4001-3			BK-80-B	45-4001-6		
“BL” TYPE							
BL-17-B	45-4001			BL-42-F	45-4001-5		
BL-17-C	45-4001			BL-49-B	45-4001-3		
BL-17-D	45-4001			BL-49-C	45-4001-3		
BL-23-B	45-4001-3			BL-49-D	45-4001-3		
BL-23-C	45-4001-3			BL-55-B	45-4001-3		
BL-23-D	45-4001-3			BL-55-C	45-4001-3		
BL-30-B	45-4001-3			BL-55-D	45-4001-3		
BL-30-C	45-4001-3			BL-55-F	45-4001-5		
BL-30-D	45-4001-3			BL-61-B	45-4001-6		
BL-36-B	45-4001-3			BL-61-C	45-4001-6		
BL-36-C	45-4001-3			BL-61-D	45-4001-6		
BL-36-D	45-4001-3			BL-67-B	45-4001-6		
BL-42-B	45-4001-3			BL-67-C	45-4001-6		
BL-42-C	45-4001-3			BL-67-D	45-4001-6		
BL-42-D	45-4001-3						
“BM” TYPE							
BM-17-B	45-4001			BM-49-D	45-4001-3		
BM-17-C	45-4001			BM-49-E	45-4001-4		
BM-17-D	45-4001			BM-49-F	45-4001-5		
BM-17-E	45-4001-1			BM-49-G	45-4001-5		
BM-23-B	45-4001-3			BM-49-H	45-4001-5		
BM-23-C	45-4001-3			BM-50-B	45-4001-3		
BM-23-D	45-4001-3			BM-50-C	45-4001-3		
BM-23-E	45-4001-4			BM-50-D	45-4001-3		
BM-24-C	45-4001-3			BM-55-B	45-4001-3		
BM-30-B	45-4001-3			BM-55-C	45-4001-3		
BM-30-C	45-4001-3			BM-55-D	45-4001-3		
BM-30-D	45-4001-3			BM-55-E	45-4001-4		
BM-36-B	45-4001-3			BM-61-B	45-4001-6		
BM-36-C	45-4001-3			BM-61-C	45-4001-6		
BM-36-D	45-4001-3			BM-67-B	45-4001-6		
BM-36-E	45-4001-4			BM-67-C	45-4001-6		
BM-42-B	45-4001-3			BM-74-B	45-4001-6		
BM-42-C	45-4001-3			BM-74-C	45-4001-6		
BM-42-D	45-4001-3			BM-80-B	45-4001-6		
BM-42-E	45-4001-4			BM-80-C	45-4001-6		
BM-49-B	45-4001-3			BM-88-B	45-4001-6		
BM-49-C	45-4001-3						



BALLAST REPLACEMENT CHART (Cont.)

To Replace Ballast No.	Use Philco Ballast	† Original UX Socket Wiring Diagram	† Rewire to Conform to Diagram	To Replace Ballast No.	Use Philco Ballast	† Original UX Socket Wiring Diagram	† Rewire to Conform to Diagram
‘ ‘ K ’ ’ TYPE							
K-11-A	45-4001			K-49-DJ	45-4001-3**		
K-11-B	45-4001			K-49-E	45-4001-4		
K-11-C	45-4001			K-49-F	45-4001-5		
K-11-D	45-4001			K-49-H	45-4001-5		
K-11-E	45-4001-1			K-49-X*	45-4001-3	U-2	RMA-B
K-17-A	45-4001			K-49-Y*	45-4001-3	U-3	RMA-C
K-17-B	45-4001			K-50-H	45-4001-5		
K-17-C	45-4001			K-52-H	45-4001-5		
K-17-D	45-4001			K-54-B	45-4001-3		
K-17-E	45-4001-1			K-55-A	45-4001-3		
K-17-BJ	45-4001 **			K-55-B	45-4001-3		
K-18-B	45-4001			K-55-BG	45-4001-3		
K-18-C	45-4001			K-55-BJ	45-4001-3**		
K-22-E	45-4001-4			K-55-C	45-4001-3		
K-23-A	45-4001-3			K-55-D	45-4001-3		
K-23-AJ	45-4001-3**			K-55-DG	45-4001-3		
K-23-B	45-4001-3			K-55-DJ	45-4001-3**		
K-23-BJ	45-4001-3**			K-55-E	45-4001-4		
K-23-C	45-4001-3			K-55-F	45-4001-5		
K-23-D	45-4001-3			K-55-G	45-4001-5		
K-23-E	45-4001-4			K-55-H	45-4001-5		
K-24-B	45-4001-3			K-55-HG	45-4001-5		
K-24-C	45-4001-3			K-60-C	45-4001-6		
K-30-A	45-4001-3			K-61-A	45-4001-6		
K-30-B	45-4001-3			K-61-B	45-4001-6		
K-30-BG	45-4001-3			K-61-C	45-4001-6		
K-30-C	45-4001-3			K-61-D	45-4001-6		
K-30-D	45-4001-3			K-61-H	45-4001-8		
K-30-E	45-4001-4			K-67-A	45-4001-6		
K-34-B*	45-4001-3	U-2	RMA-B	K-67-B	45-4001-6		
K-36-A	45-4001-3			K-67-BJ	45-4001-6**		
K-36-AJ	45-4001-3**			K-67-D	45-4001-6		
K-36-B	45-4001-3			K-70-A	45-4001-6		
K-36-BG	45-4001-3			K-70-B	45-4001-6		
K-36-BJ	45-4001-3**			K-70-C	45-4001-6		
K-36-C	45-4001-3			K-70-D	45-4001-6		
K-36-CG	45-4001-3			K-72-A	45-4001-6		
K-36-D	45-4001-3			K-72-B	45-4001-6		
K-36-DG	45-4001-3			K-72-C	45-4001-6		
K-36-E	45-4001-4			K-72-D	45-4001-6		
K-36-F	45-4001-5			K-74-A	45-4001-6		
K-36-FG	45-4001-5			K-74-B	45-4001-6		
K-36-H	45-4001-5			K-74-BG	45-4001-6		
K-38-B	45-4001-3			K-74-BJ	45-4001-6**		
K-40-B	45-4001-3			K-74-C	45-4001-6		
K-40-C	45-4001-3			K-74-CG	45-4001-6		
K-40-Y*	45-4001-3	U-3	RMA-C	K-74-CJ	45-4001-6**		
K-42-A	45-4001-3			K-74-D	45-4001-6		
K-42-B	45-4001-3			K-75-A	45-4001-6		
K-42-B2	45-4001-3			K-75-B	45-4001-6		
K-42-BJ	45-4001-3**			K-75-C	45-4001-6		
K-42B-MG	45-4001-3			K-76-B	45-4001-6		
K-42-C	45-4001-3			K-76-C	45-4001-6		
K-42-D	45-4001-3			K-78-A	45-4001-6		
K-42-E	45-4001-4			K-78-B	45-4001-6		
K-42-F	45-4001-5			K-78-C	45-4001-6		
K-42-H	45-4001-5			K-78-D	45-4001-6		
K-43-H	45-4001-5			K-78-F	45-4001-8		
K-43-B2	45-4001-3			K-78-H	45-4001-8		
K-49-A	45-4001-3			K-79-1	45-4001-6		
K-49-B	45-4001-3			K-79-B	45-4001-6		
K-49-BG	45-4001-3			K-79-C	45-4001-6		
K-49-BJ	45-4001-3**			K-79-D	45-4001-6		
K-49-C	45-4001-3			K-80-A	45-4001-6		
K-49-CB	45-4001-3			K-80-B	45-4001-6		
K-49-CG	45-4001-3			K-80-C	45-4001-6		
K-49-CJ	45-4001-3**			K-80-D	45-4001-6		
K-49-D	45-4001-3			K-80-F	45-4001-8		



BALLAST REPLACEMENT CHART (Cont.)

To Replace Ballast No.	Use Philco Ballast	† Original UX Socket Wiring Diagram	† Rewire to Conform to Diagram	To Replace Ballast No.	Use Philco Ballast	† Original UX Socket Wiring Diagram	† Rewire to Conform to Diagram
“K” TYPE (Cont.)							
K-80-FG	45-4001-8			K-92-C	45-4001-6		
K-80-H	45-4001-8			K-92-D	45-4001-6		
K-80-HG	45-4001-8			K-92-F	45-4001-8		
K-82-A	45-4001-6			K-92-FG	45-4001-8		
K-82-B	45-4001-6			K-92-H	45-4001-8		
K-82-C	45-4001-6			K-92-HG	45-4001-8		
K-82-D	45-4001-6			K-94-A	45-4001-6		
K-82-F	45-4001-8			K-94-B	45-4001-6		
K-82-FG	45-4001-8			K-94-C	45-4001-6		
K-82-H	45-4001-8			K-94-D	45-4001-6		
K-82-HG	45-4001-8			K-94-F	45-4001-8		
K-86-A	45-4001-6			K-95-A	45-4001-6		
K-86-B	45-4001-6			K-95-B	45-4001-6		
K-86-C	45-4001-6			K-95-C	45-4001-6		
K-86-D	45-4001-6			K-95-D	45-4001-6		
K-87-A	45-4001-6			K-95-F	45-4001-8		
K-87-B	45-4001-6			K-98-A	45-4001-9		
K-87-C	45-4001-6			K-98-B	45-4001-9		
K-87-D	45-4001-6			K-98-C	45-4001-9		
K-90-A	45-4001-6			K-98-D	45-4001-9		
K-90-B	45-4001-6			K-105-A	45-4001-9		
K-90-C	45-4001-6			K-105-B	45-4001-9		
K-90-D	45-4001-6			K-105-C	45-4001-9		
K-90-F	45-4001-8			K-83747-1	45-4001-3		
K-90-H	45-4001-8			K-83747-2	45-4001-3		
K-90-HG	45-4001-8			K-83747-3	45-4001-3		
K-92-A	45-4001-6			K-83747-4	45-4001-3		
K-92-B	45-4001-6			K-83747-5	45-4001-6		
“KX” TYPE							
KX-23-B*	45-4001-3	U-2	RMA-B	KX-74-B*	45-4001-6	U-2	RMA-B
KX-42-A*	45-4001-3	U-1	RMA-A	KX-74-C*	45-4001-6	U-3	RMA-C
KX-42-B*	45-4001-3	U-2	RMA-B	KX-74-D*	45-4001-6	U-4	RMA-D
KX-42-C*	454-001-3	U-3	RMA-C	KX-80-A*	45-4001-6	U-1	RMA-A
KX-42-D*	45-4001-3	U-4	RMA-D	KX-80-B*	45-4001-6	U-2	RMA-B
KX-45-A*	45-4001-3	U-1	RMA-A	KX-80-C*	45-4001-6	U-3	RMA-C
KX-49-A*	45-4001-3	U-1	RMA-A	KX-80-D*	45-4001-6	U-4	RMA-D
KX-49-B*	45-4001-3	U-2	RMA-B	KX-86-A*	45-4001-6	U-1	RMA-A
KX-49-C*	45-4001-3	U-3	RMA-C	KX-86-B*	45-4001-6	U-2	RMA-B
KX-49-D*	45-4001-3	U-4	RMA-D	KX-86-C*	45-4001-6	U-3	RMA-C
KX-55-A*	45-4001-3	U-1	RMA-A	KX-86-D*	45-4001-6	U-4	RMA-D
KX-55-B*	45-4001-3	U-2	RMA-B	KX-92-A*	45-4001-9	U-1	RMA-A
KX-55-C*	45-4001-3	U-3	RMA-C	KX-92-B*	45-4001-9	U-2	RMA-B
KX-55-D*	45-4001-3	U-4	RMA-D	KX-92-C*	45-4001-9	U-3	RMA-C
KX-61-A*	45-4001-6	U-1	RMA-A	KX-98-A*	45-4001-9	U-1	RMA-A
KX-61-B*	45-4001-6	U-2	RMA-B	KX-98-B*	45-4001-9	U-2	RMA-B
KX-61-D*	45-4001-6	U-4	RMA-D	KX-98-C*	45-4001-9	U-3	RMA-C
KX-67-A*	45-4001-6	U-1	RMA-A	KX-105-A*	45-4001-9	U-1	RMA-A
KX-67-B*	45-4001-6	U-2	RMA-B	KX-105-B*	45-4001-9	U-2	RMA-B
KX-67-D*	45-4001-6	U-4	RMA-D	KX-105-C*	45-4001-9	U-3	RMA-C
KX-74-A*	45-4001-6	U-1	RMA-A				
“L” TYPE							
L-10-C	45-4001			L-22-B	45-4001-3		
L-11-B	45-4001			L-23-B	45-4001-3		
L-11-BG	45-4001			L-23-C	45-4001-3		
L-11-C	45-4401			L-23-D	45-4001-3		
L-11-D	45-4001			L-23-E	45-4001-4		
L-15-B	45-4001			L-24-B	45-4001-3		
L-15-C	45-4001			L-24-C	45-4001-3		
L-15-D	45-4001			L-26-B	45-4001-3		
L-17-B	45-4001			L-30-B	45-4001-3		
L-17-C	45-4001			L-30-C	45-4001-3		
L-17-D	45-4001			L-30-D	45-4001-3		
L-17-E	45-4001-1			L-32-B	45-4001-3		



BALLAST REPLACEMENT CHART (Cont.)

To Replace Ballast No.	Use Philco Ballast	† Original UX Socket Wiring Diagram	† Rewire to Conform to Diagram	To Replace Ballast No.	Use Philco Ballast	† Original UX Socket Wiring Diagram	† Rewire to Conform to Diagram
“L” TYPE (Cont.)							
L-32-C	45-4001-3			L-55-B	45-4001-3		
L-34-B	45-4001-3			L-55-BG	45-4001-3		
L-34-C	45-4001-3			L-55-BJ	45-4001-3**		
L-36-B	45-4001-3			L-55-C	45-4001-3		
L-36-C	45-4001-3			L-55-CG	45-4001-3		
L-36-D	45-4001-3			L-55-CJ	45-4001-3**		
L-36-DG	45-4001-3			L-55-D	45-4001-3		
L-36-DJG	45-4001-3**			L-55-DJ	45-4001-3**		
L-36-IJ	45-4001-3**			L-55DJG	45-4001-3**		
L-36-E	45-4001-4			L-55-E	45-4001-4		
L-38-B	45-4001-3			L-55-5.5E	45-4001-4		
L-38-C	45-4001-3			L-55-F	45-4001-5		
L-38-D	45-4001-3			L-55-FG	45-4001-5		
L-39-B	45-4001-3			L-55-H	45-4001-5		
L-39-C	45-4001-3			L-55-HG	45-4001-5		
L-39-D	45-4001-3			L-59-BJ	45-4001-6**		
L-39-DJ	45-4001-3**			L-61-B	45-4001-6		
L-40-C	45-4001-3			L-61-BG	45-4001-6		
L-40-D	45-4001-3			L-61-BJ	45-4001-6**		
L-40-E	45-4001-4			L-61-C	45-4001-6		
L-42-B	45-4001-3			L-61-CG	45-4001-6		
L-42-BG	45-4001-3			L-61-CJ	45-4001-6**		
L-42-BJ	45-4001-3**			L-61-D	45-4001-6		
L-42-C	45-4001-3			L-61-E	45-4001-7		
L-42-CG	45-4001-3			L-61-F	45-4001-8		
L-42-CJ	45-4001-3**			L-61-G	45-4001-8		
L-42-E	45-4001-4			L-61-H	45-4001-7		
L-42-F	45-4001-5			L-67-B	45-4001-6		
L-42-FG	45-4001-5			L-67-BG	45-4001-6		
L-48-B	45-4001-3			L-67-C	45-4001-6		
L-48-C	45-4001-3			L-67-CG	45-4001-6		
L-48-D	45-4001-3			L-67-D	45-4001-6		
L-49-B	45-4001-3			L-70-B	45-4001-6		
L-49-BG	45-4001-3			L-70-C	45-4001-6		
L-49-BJ	45-4001-3**			L-70-D	45-4001-6		
L-49-BJG	45-4001-3**			L-72-B	45-4001-6		
L-49-C	45-4001-3			L-72-C	45-4001-6		
L-49-CG	45-4001-3			L-72-D	45-4001-6		
L-49-CJ	45-4001-3**			L-73-B	45-4001-6		
L-49-D	45-4001-3			L-74-B	45-4001-6		
L-49-DG	45-4001-3			L-74-C	45-4001-6		
L-49-DJ	45-4001-3**			L-74-D	45-4001-6		
L-49-DJG	45-4001-3**			L-80-B	45-4001-6		
L-49-E	45-4001-4			L-80-BG	45-4001-6		
L-49-F	45-4001-5			L-80-BJ	45-4001-6**		
L-49-FG	45-4001-5			L-80-C	45-4001-6		
L-49-HG	45-4001-5			L-80-D	45-4001-6		
L-49-H	45-4001-5			L-81-B	45-4001-6		
L-49-5.5-E	45-4001-4			L-81-BJ	45-4001-6**		
L-54-C	45-4001-3			L-91-D	45-4001-6		
L-54-D	45-4001-3						
“LX” TYPE							
LX-42-B*	45-4001-3	U-2	RMA-B	LX-55-C*	45-4001-3	U-3	RMA-C
LX-42-C*	45-4001-3	U-3	RMA-C	LX-55-D*	45-4001-3	U-4	RMA-D
LX-42-D*	45-4001-3	U-4	RMA-D	LX-74-B*	45-4001-6	U-2	RMA-B
LX-49-B*	45-4001-3	U-2	RMA-B	LX-74-C*	45-4001-6	U-3	RMA-C
LX-49-C*	45-4001-3	U-3	RMA-C	LX-80-B*	45-4001-6	U-2	RMA-B
LX-49-D*	45-4001-3	U-4	RMA-D	LX-80-C*	45-4001-6	U-3	RMA-C
LX-55-B*	45-4001-3	U-2	RMA-B	LX-80-D*	45-4001-6	U-4	RMA-D
“M” TYPE							
M-17-B	45-4001			M-17-E	45-4001-1		
M-17-BG	45-4001			M-17-EG	45-4001-1		
M-17-C	45-4001			M-17-F	45-4001-2		
M-17-D	45-4001			M-17-FG	45-4001-2		



BALLAST REPLACEMENT CHART (Cont.)

To Replace Ballast No.	Use Philco Ballast	† Original UX Socket Wiring Diagram	† Rewire to Conform to Diagram	To Replace Ballast No.	Use Philco Ballast	† Original UX Socket Wiring Diagram	† Rewire to Conform to Diagram
'M' TYPE (Cont.)							
M-17-H	45-4001-2			M-44-B	45-4001-3		
M-17-HG	45-4001-2			M-44-C	45-4001-3		
M-22-HG	45-4001-5			M-44-D	45-4001-3		
M-23-B	45-4001-3			M-49-A	45-4001-3		
M-23-BG	45-4001-3			M-49-B	45-4001-3		
M-23-BJ	45-4001-3**			M-49-BG	45-4001-3		
M-23-C	45-4001-3			M-49-C	45-4001-3		
M-23-D	45-4001-3			M-49-CG	45-4001-3		
M-23-E	45-4001-4			M-49-D	45-4001-3		
M-23-F	45-4001-5			M-49-DG	45-4001-3		
M-23-FG	45-4001-5			M-49-E	45-4001-4		
M-23-H	45-4001-5			M-49-F	45-4001-5		
M-23-HG	45-4001-5			M-49-FG	45-4001-5		
M-30-B	45-4001-3			M-49-H	45-4001-5		
M-30-BG	45-4001-3			M-49-HG	45-4001-5		
M-30-C	45-4001-3			M-55-B	45-4001-3		
M-30-CG	45-4001-3			M-55-BG	45-4001-3		
M-30-D	45-4001-3			M-55-BJ	45-4001-3**		
M-30-E	45-4001-4			M-55-C	45-4001-3		
M-30-F	45-4001-5			M-55-CG	45-4001-3		
M-30-FG	45-4001-5			M-55-D	45-4001-3		
M-30-H	45-4001-5			M-55-DG	45-4001-3		
M-30-HG	45-4001-5			M-55-E	45-4001-4		
M-32-B	45-4001-3			M-55-EG	45-4001-4		
M-32-C	45-4001-3			M-55-F	45-4001-5		
M-32-D	45-4001-3			M-55-FG	45-4001-5		
M-32-F	45-4001-5			M-55-H	45-4001-5		
M-32-H	45-4001-4			M-55-HG	45-4001-5		
M-33-B	45-4001-3			M-61-B	45-4001-6		
M-33-C	45-4001-3			M-61-BG	45-4001-6		
M-33-D	45-4001-3			M-61-C	45-4001-6		
M-33-H	45-4001-5			M-61-CG	45-4001-6		
M-34-B	45-4001-3			M-61-D	45-4001-6		
M-34-C	45-4001-3			M-67-B	45-4001-6		
M-34-D	45-4001-3			M-67-C	45-4001-6		
M-36-B	45-4001-3			M-67-D	45-4001-6		
M-36-BG	45-4001-3			M-73-B	45-4001-6		
M-36-C	45-4001-3			M-74-B	45-4001-6		
M-36-CG	45-4001-3			M-74-BG	45-4001-6		
M-36-D	45-4001-3			M-74-C	45-4001-6		
M-36-E	45-4001-4			M-74-D	45-4001-6		
M-36-F	45-4001-5			M-79-B	45-4001-6		
M-36-FG	45-4001-5			M-79-C	45-4001-6		
M-36-H	45-4001-5			M-80-B	45-4001-6		
M-36-HG	45-4001-5			M-80-C	45-4001-6		
M-38-B	45-4001-3			M-80-D	45-4001-6		
M-38-C	45-4001-3			M-80-E	45-4001-7		
M-38-D	45-4001-3			M-80-F	45-4001-8		
M-38-E	45-4001-4			M-80-H	45-4001-8		
M-38-F	45-4001-5			M-80-HG	45-4001-8		
M-38-H	45-4001-5			M-84-F	45-4001-9		
M-40-B	45-4001-3			M-90-B	45-4001-6		
M-40-C	45-4001-3			M-90-C	45-4001-6		
M-40-CG	45-4001-3			M-90-D	45-4001-6		
M-40-D	45-4001-3			M-90-E	45-4001-7		
M-40-E	45-4001-4			M-90-F	45-4001-8		
M-40-F	45-4001-5			M-90-FG	45-4001-8		
M-40-H	45-4001-5			M-90-H	45-4001-8		
M-42-B	45-4001-3			M-90-HG	45-4001-8		
M-42-BG	45-4001-3			M-92-B	45-4001-6		
M-42-C	45-4001-3			M-92-BG	45-4001-6		
M-42-CG	45-4001-3			M-92-C	45-4001-6		
M-42-D	45-4001-3			M-92-CG	45-4001-6		
M-42-E	45-4001-4			M-92-D	45-4001-6		
M-42-F	45-4001-5			M-92-F	45-4001-8		
M-42-FG	45-4001-5			M-92-FG	45-4001-8		
M-42-H	45-4001-5			M-92-H	45-4001-8		
M-42-HG	45-4001-5			M-92-HG	45-4001-8		



BALLAST REPLACEMENT CHART (Cont.)

“M” TYPE (Cont.)

To Replace Ballast No.	Use Philco Ballast	† Original UX Socket Wiring Diagram	† Rewire to Conform to Diagram	To Replace Ballast No.	Use Philco Ballast	† Original UX Socket Wiring Diagram	† Rewire to Conform to Diagram
M-95-B	45-4001-6			M-95-F	45-4001-8		
M-95-C	45-4001-6			M-95-H	45-4001-8		
M-95-D	45-4001-6						

“MX” TYPE

MX-42-B*	45-4001-3	U-2	RMA-B	MX-74-B*	45-4001-6	U-2	RMA-B
MX-42-C*	45-4001-3	U-3	RMA-C	MX-80-B*	45-4001-6	U-2	RMA-B
MX-42-D*	45-4001-3	U-4	RMA-D	MX-80-C*	45-4001-6	U-3	RMA-C
MX-49-B*	45-4001-3	U-2	RMA-B	W-46773	45-4001-3		
MX-49-C*	45-4001-3	U-3	RMA-C	W-46416	45-4001-3		
MX-55-B*	45-4001-3	U-2	RMA-B	W-43357	45-4001-3		
MX-55-C*	45-4001-3	U-3	RMA-C	Y-TU-9	45-4001-3		



REPLACEMENT CROSS INDEX

Numerical	"BK"	"BL"	"BM"	"K"	"L"	"M"	"KX"	"LX"	"MX"
45-4001 REPLACES									
10A	BK11B	BL17B	BM17B	K11A	L10C	M17B			
11AJ	BK11C	BL17C	BM17C	K11B	L11B	M17BG			
17A	BK11D	BL17D	BM17D	K11C	L11BG	M17C			
17AJ	BK17B			K11D	L11C	M17D			
85R8	BK17C			K17A	L11D				
90R8	BK17D			K17B	L15B				
94R8				K17C	L15C				
				K17D	L15D				
				K17Bj	L17B				
				K18B	L17C				
				K18C	L17D				
45-4001-1 REPLACES									
16037	BK17E		BM17E	K11E	L17E	M17E			
				K17E		M17EG			
45-4001-2 REPLACES									
						M17F			
						M17FG			
						M17H			
						M17HG			
45-4001-3 REPLACES									
2UR	BK23B	BL23B	BM23B	K23A	L22B	M23B	KX23B	LX42B	MX42B
2VR	BK23C	BL23C	BM23C	K23AJ	L23B	M23BG	KX42A	LX42C	MX42C
3CR	BK23D	BL23D	BM23D	K23B	L23C	M23Bj	KX42B	LX42D	MX42D
3ER	BK24C	BL30B	BM24C	K23Bj	L23D	M23C	KX42C	LX49B	MX49B
5B	BK29B	BL30C	BM30B	K23C	L24B	M23D	KX42D	LX49C	MX49C
6B	BK29C	BL30D	BM30C	K23D	L24C	M30B	KX45A	LX49D	MX55B
6.125	BK29D	BL36B	BM30D	K24B	L26B	M30BG	KX49A	LX55B	MX55C
6.126	BK30B	BL36C	BM36B	K24C	L30B	M30C	KX49B	LX55C	W46773
6.129	BK30C	BL36D	BM36C	K30A	L30C	M30CG	KX49C	LX55D	W46416
6.133	BK30D	BL42B	BM36D	K30B	L30D	M30D	KX49D		W43357
6.133A	BK32D	BL42C	BM42B	K30BG	L32B	M32B	KX55A		Y-TU-9
6.135	BK36B	BL42D	BM42C	K30C	L32C	M32C	KX55B		
30AG	BK36C	BL49B	BM42D	K30D	L34B	M32D	KX55C		
30AJ	BK36D	BL49C	BM49B	K34B	L34C	M33B	KX55D		
30LB	BK42B	BL49D	BM49C	K36A	L36B	M33C			
30LC	BK42BG	BL55B	BM49D	K36AJ	L36C	M33D			
30LD	BK42C	BL55C	BM50B	K36B	L36D	M34B			
36A	BK42D	BL55D	BM50C	K36BG	L36DG	M34C			
36AG	BK42DG		BM50D	K36Bj	L36DJG	M34D			
37A	BK49B		BM55B	K36C	L36H	M36B			
40	BK49BG		BM55C	K36CG	L38B	M36BG			
40A2	BK49C		BM55D	K36D	L38C	M36C			
42A (Octal)	BK49Cj			K36DG	L38D	M36CG			
42A (UX)	BK49D			K38B	L39B	M36D			
42AG	BK49DG			K40B	L39C	M38B			
45W	BK49D10			K40C	L39D	M38C			
49B	BK55B			K40Y	L39DJ	M38D			
49C	BK55BG			K42A	L40C				
49W	BK55Bj			K42B	L40D				
50	BK55C			K42B2	L42B				
50A2	BK55D			K42Bj	L42BG				
50B2				K42B-MG	L42Bj				
50W				K42C	L42C				
50X3				K42D	L42CG				
50X300				K43B2	L42Cj				
50X3T				K49A	L48B				
55A				K49B	L48C				
55KA				K49BG	L48D				
55KB				K49Bj	L49B				
55KC				K49C	L49BG				
55LB				K49CB	L49Bj				
55LC				K49CG	L49BjG				



REPLACEMENT CROSS INDEX (Cont.)

Numerical	"BK"	"BL"	"BM"	"K"	"L"	"M"	"KX"	"LX"	"MX"
45-4001-3 REPLACES (Cont.)									
55MB				K49CJ	L49C				
55MC				K49D	L49CG				
60R30				K49DJ	L49CJ				
60R30G				K49X	L49D				
95K2				K49Y	L49DG				
100.37				K54B	L49DJ				
100.38				K55A	L49DJG				
100.45				K55B	L54C				
100.70				K55BG	L54D				
100R				K55BJ	L55B				
100R4				K55C	L55BG				
100R8				K55D	L55BJ				
115.22				K55DG	L55C				
115.28				K55DJ	L55CG				
115.40				K83747-1	L55CJ				
115.41				K83747-2	L55D				
115.42				K83747-3	L55DJ				
115.53				K83747-4	L55DJG				
115.53X					L59BJ				
115.55									
115.65									
120R8									
135E1									
135K1A									
140A									
140KB (Octal)									
140KB (UX)									
140KC (Octal)									
140KC (UX)									
140L4									
140L8									
140L44									
140LB (Octal)									
140LB (UX)									
140LC (Octal)									
140LC (UX)									
140LD (Octal)									
140LD (UX)									
140M4									
140M8									
140R									
140R4									
140R8									
140R44									
160R4									
165A									
165KB (Octal)									
165KB (UX)									
165KC (Octal)									
165KC (UX)									
165KD (Octal)									M40B
165KD (UX)									M40C
165L4									M40CG
165L8									M40D
165L44									M42B
165LB (Octal)									M42BG
165LB (UX)									M42C
165LC (Octal)									M42CG
165LC (UX)									M42D
165LD (Octal)									M44B
165LD (UX)									M44C
165M4									M44D
165M8									M49A
165R									M49B
165R4									M49BG
165R8									M49C
165R44									M49CG
170K1									M49D



REPLACEMENT CROSS INDEX (Cont.)

Numerical	"BK"	"BL"	"BM"	"K"	"L"	"M"	"KX"	"LX"	"MX"
45-4001-3 REPLACES (Cont.)									
180A									M49DG
180KB (Octal)									M55B
180KB (UX)									M55BG
180KC (Octal)									M55BJ
180KC (UX)									M55C
180KD (Octal)									M55CG
180KD (UX)									M55D
185A									M55DG
185KB (Octal)									
185KB (UX)									
185KC (Octal)									
185KC (UX)									
185KD (Octal)									
185KD (UX)									
185L4									
185L8									
185L44									
185LB (Octal)									
185LB (UX)									
185LC (Octal)									
185LC (UX)									
185LD (Octal)									
185LD (UX)									
185M4									
185M8									
185R									
185R4									
185R8									
185R44									
340									
2903									
2904									
2905									
2906									
8593									
8598									
16035									
16036									
A-16040									
81966-2									
81996									
45-4001-4 REPLACES									
BK23E			BM23E	K22E	L23E	M23E			
BK36E			BM36E	K23E	L36E	M30E			
BK42E			BM42E	K30E	L40E	M32H			
BK49E			BM49E	K36E	L42E	M36E			
BK55E			BM55E	K42E	L49E	M38E			
				K49E	L49-5.5E	M40E			
				K55E	L55E	M42E			
					L55-5.5E	M49E			
						M55E			
						M55EG			
45-4001-5 REPLACES									
32	BK30H	BL42F	BM49F	K36F	L42F	M22HG			
36H	BK36F	BL55F	BM49G	K36FG	L42FG	M23F			
42HA	BK36H		BM49H	K36H	L49F	M23FG			
49H	BK52H			K42F	L49FG	M23H			
52H	BK55F			K42H	L49HG	M23HG			
				K43H	L49H	M20H			
				K49F	L55F	M30FG			
				K49H	L55FG	M30H			
				K50H	L55H	M30HG			
				K52H	L55HG	M32F			
				K55F		M33H			



REPLACEMENT CROSS INDEX (Cont.)

Numerical	"BK"	"BL"	"BM"	"K"	"L"	"M"	"KX"	"LX"	"MX"
45-4001-5 REPLACES (Cont.)									
				K55G		M36F			
				K55H		M36FG			
				K55HG		M36H			
						M36HG			
						M38F			
						M38H			
						M40F			
						M40H			
						M42F			
						M42FG			
						M42H			
						M42HG			
						M49F			
						M49FG			
						M49H			
						M49HG			
						M55F			
						M55FG			
						M55H			
						M55HG			
45-4001-6 REPLACES									
61A	BK61B	BL61B	BM61B	K60C	L59BJ	M61B	KX61A	LX74B	MX49C
61KB	BK61D	BL61C	BM61C	K61A	L61B	M61BG	KX61B	LX74C	MX74B
61KC	BK61G	BL61D	BM67B	K61B	L61BG	M61C	KX61D	LX80B	MX80B
61MB	BK67B	BL67B	BM67C	K61C	L61BJ	M61CG	KX67A	LX80C	MX80C
61MC	BK67C	BL67C	BM74B	K61D	L61C	M61D	KX67B	LX90D	
62A	BK67D	BL67D	BM74C	K67A	L61CG	M67B	KX67D		
67A	BK80B		BM80B	K67B	L61CJ	M67C	KX74A		
67KB			BM80C	K67BJ	L61D	M67D	KX74B		
67KC			BM88B	K67D	L67B	M73B	KX74C		
67KD				K70A	L67BG	M74B	KX74D		
74A				K70B	L67C	M74BG	KX80A		
74KA				K70C	L67CG	M74C	KX80B		
74KB				K70D	L67D	M74D	KX80C		
74KC				K72A	L70B	M79B	KX80D		
74KD				K72B	L70C	M79C	KX86A		
79A				K72C	L70D	M80B	KX86B		
79KB				K72D	L72B	M80C	KX86C		
79KC				K74A	L72C	M80D	KX86D		
80A				K74B	L72D	M90B			
82A				K74BG	L73B	M90C			
82LB				K74BJ	L74B	M90D			
86A				K74C	L74C	M92B			
88A				K74CG	L74D	M92BG			
92A				K74CJ	L80B	M92C			
190KI				K74D	L80BG	M92CG			
200R				K75A	L80BJ	M92D			
200R4				K75B	L80C	M95B			
200R8				K75C	L80D	M95C			
245A				K76B	L81B	M95D			
245KB (Octal)				K76C	L81BJ				
245KB (UX)				K78A	L91D				
245KC (Octal)				K78B					
245KC (UX)				K78C					
250A				K78D					
250KB (Octal)				K79-1					
250KB (UX)				K79B					
250KC (Octal)				K79C					
250KC (UX)				K79D					
250L4				K80A					
250L8				K80B					
250M4				K80C					
250M8				K80D					
250R				K82A					
250R4				K82B					
250R8				K82C					



REPLACEMENT CROSS INDEX (Cont.)

Numerical	"BK"	"BL"	"BM"	"K"	"L"	"M"	"KX"	"LX"	"MX"
45-4001-6 REPLACES (Cont.)									
270KB (Octal)				K82D					
270KB (UX)				K86A					
270KC (Octal)				K86B					
270KC (UX)				K86C					
270L4				K86D					
270L8				K87A					
270M4				K87B					
270M8				K87C					
270R				K87D					
270R8				K90A					
2922				K90B					
2923				K90C					
16032				K90D					
				K92A					
				K92B					
				K92C					
				K92D					
				K94A					
				K94B					
				K94C					
				K94D					
				K95A					
				K95B					
				K95C					
				K95D					
				K83747-5					
45-4001-7 REPLACES									
BK61E				L61E	M80E				
				L61H	M90E				
45-4001-8 REPLACES									
				K61H	L61F	M80F			
				K78F	L61G	M80H			
				K78H		M80HG			
				K80F		M84F			
				K80FG		M90F			
				K80H		M90FG			
				K80HG		M90H			
				K82F		M90HG			
				K82FG		M92F			
				K82H		M92FG			
				K82HG		M92H			
				K90F		M92HG			
				K90H		M95F			
				K90HG		M95H			
				K92F					
				K92FG					
				K92H					
				K92HG					
				K94F					
				K95F					
45-4001-9 REPLACES									
				K98A			KX92A		
				K98B			KX92B		
				K98C			KX92C		
				K98D			KX98A		
				K105A			KX98B		
				K105B			KX98C		
				K105C			KX105A		
							KX105B		
							KX105C		

PHILCO DRY BATTERIES

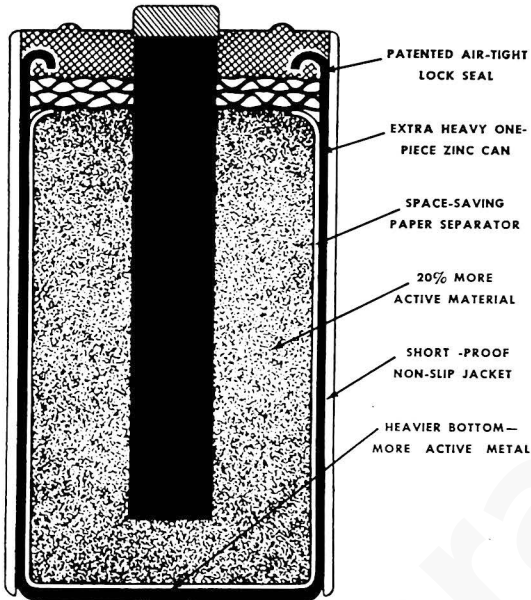

The following pages illustrate and list:

- Philco Radio "B" and "C" Batteries
- Philco Radio "A" and "B-C" Batteries
- Philco Portable Batteries
- Philco Flashlight and All-Purpose Batteries
- Philco Farm-Radio Batteries

A listing of batteries of different makes, and the Philco batteries which are interchangeable with them, is included for easy reference. Listings of Philco battery replacements for Philco farm radios and for portable radios of all makes are also included.

The new line of Philco dry batteries is designed to fill every requirement for original-design and replacement purposes.

Fresh stocks are assured by the widespread acceptance and sale of Philco batteries, a result of carefully controlled manufacturing processes and the use of high-quality materials.

FEATURES

HEAVIER ONE-PIECE ZINC CAN—Made by patented extruding machine instead of usual "drawing" or soldering. No seams, no joints, no leaks. Thick wall, with no thin spots, assures even chemical action and long life. 99.9% pure zinc wears longer.

SPACE-SAVING PAPER SEPARATOR—This patented feature makes possible Philco Dry Batteries with the thinnest, most efficient dry-battery separator ever devised. Holds more moisture; holds it longer. Takes less space; makes room for more active material.

PATENTED AIR-TIGHT LOCK SEAL—Zinc can is curled in to form an airtight lock within the sealing compound. This hermetic seal keeps the moisture within, keeps air out, maintains the proper chemical action until the last ounce of energy is used.

HEAVIER BOTTOM—In Philco Dry Batteries the heavier bottom of the zinc can actually generate current. In ordinary batteries the bottom is made inactive by the insertion of a cardboard washer to prevent the passage of chemical solution. Another reason why a Philco delivers full voltage—longer.

MORE ACTIVE MATERIAL—More electrolytic mix is loaded into Philco cells, because of the Philco separator, which is much thinner than is commonly used. And Philco cells are filled to the top!

NON-SLIP JACKET—The Philco method of cementing the jacket to the cell provides effective permanent insulation and prevents short circuits. The jacket cannot slip off to cause waste of current and exhaustion of the active ingredients.



PHILCO RADIO "B" AND "C" BATTERIES

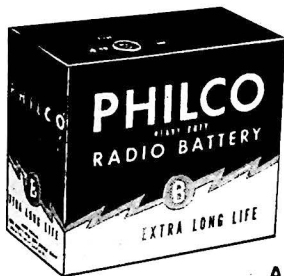

A



B

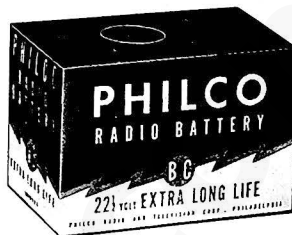

C

FIG.	CLASSIFICATION	TYPE NO.	VOLTAGE	VOLTAGE TAPS	STANDARD PACKAGE	SIZE IN INCHES			WEIGHT IN LBS. PER STANDARD PACKAGE	LIST PRICE
						LENGTH	WIDTH	HEIGHT		
A	Radio "B" super heavy duty	P-30-FL	45	$\pm 22\frac{1}{2}$, +45	3	$7\frac{7}{8}$	$4\frac{1}{2}$	7	41	\$3.35
A	Radio "B" heavy duty	P-30-F	45	$\pm 22\frac{1}{2}$, +45	6	$7\frac{7}{8}$	$4\frac{1}{4}$	7	71	2.95
A	Radio "B" standard	P-30-D	45	$\pm 22\frac{1}{2}$, +45	6	$7\frac{7}{8}$	$3\frac{1}{8}$	7	46	2.50
A	Radio "C" standard	P-3-D	$4\frac{1}{2}$	± 3 , $-4\frac{1}{2}$	10	4	$1\frac{3}{8}$	3	8	.75
B	Radio "C" standard	P-5-B	$7\frac{1}{2}$	$\pm 1\frac{1}{2}$, -3, $-4\frac{1}{2}$, -6, $-7\frac{1}{2}$	10	$4\frac{1}{16}$	$\frac{7}{8}$	$33/16$	6	.90
C	Radio "C" standard	P-15-B5	$22\frac{1}{2}$	± 3 , $-4\frac{1}{2}$, $-16\frac{1}{2}$, $-22\frac{1}{2}$	10	$4\frac{1}{8}$	$2\frac{1}{2}$	$2\frac{7}{8}$	15	1.70

PHILCO RADIO "A" AND "B-C" BATTERIES

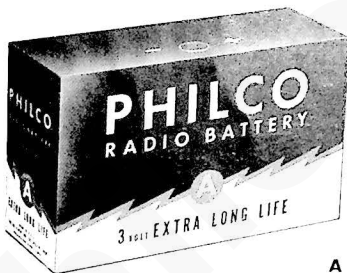

A

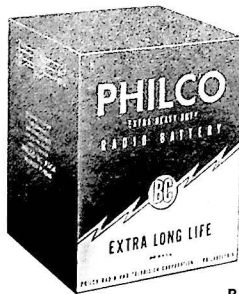

B



C

FIG.	CLASSIFICATION	TYPE NO.	VOLTAGE			STANDARD PACKAGE	SIZE IN INCHES			WEIGHT IN LBS. PER STANDARD PACKAGE	LIST PRICE
			A	B	C		LENGTH	WIDTH	HEIGHT		
A	Radio "A"	P-8024	3			1	$10\frac{5}{8}$	4	$6\frac{3}{4}$	17	\$4.75
B	Radio "B-C"	P-9068		135	-9	1	$8\frac{13}{16}$	$8\frac{1}{8}$	$11\frac{1}{4}$	42	10.50
C	Mystery pack	BB30-12P	3	45		6	4	$1\frac{1}{8}$	$63/16$	13	3.25



PHILCO PORTABLE BATTERIES

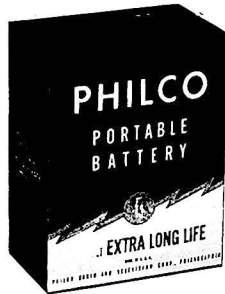

A

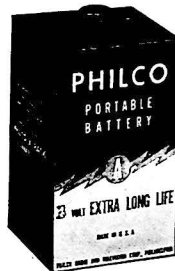

B

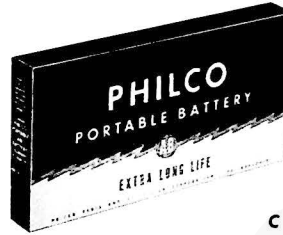

C

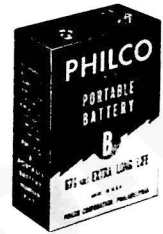

E



D

FIG.	CLASSIFICATION	TYPE NO.	VOLTAGE			STANDARD PACKAGE	SIZE IN INCHES			WEIGHT IN LBS PER STANDARD PACKAGE	LIST PRICE
			A	B	C		LENGTH	WIDTH	HEIGHT		
A	Portable "B"	P-305		45		6	4 1/8	27 1/8	5 1/8	17	2.15
B	Portable "A"	P-94	1 1/2			6	29 1/8	29 1/8	4 1/2	12	.90
A	Heavy-duty portable "A"	P-8F1	1 1/2			5	37 3/8	29 1/8	5 3/8	15	1.60
C	Portable "A-B"	P-41A-4FL	1 1/2	6 1 1/2		6	9 3/8	2	4 3/4	26 1/2	3.85
C	Portable "A-B"	P-60A-4L	1 1/2	90		6	12	17 1/8	6 5/8	38 1/2	5.25
C	Portable "A-B"	P-60A-110	6	90		6	12 1/4	17 1/8	6 5/8	38 1/2	5.25
D	Portable "A-B"	P-60A-8F4	6	90		6	12	2 5/8	4 1/4	42	5.25
D	Portable "A-B"	P-41A-4G	1 1/2	6 1 1/2		6	9 7/8	2 5/8	3 3/8	28	3.85
D	Portable "A-B"	P-89	1 1/2	60		6	7 7/8	29 1/8	1 1/4	10 1/2	3.00
D	Portable "A-B"	P-87	7 1/2	63		6	9 1/2	4	2 5/8	30	4.35
D	Portable "A-B"	P-841-A	7 1/2 or 9	90		6	9 1/2	2 5/8	4 1/4	36	5.25
D	Portable "A-B"	P-60B-6F6	9	90		1	13 7/8	2 3/4	4 11/16	9	5.45
A	Portable "A"	P-100	4 1/2			6	31 5/8	1 3/8	4 3/4	8 1/2	.75
A	Portable "B"	P-200		45		6	4 1/4	17 1/8	5 5/8	12	2.15
A	Portable "B"	P-210		45		6	3 3/8	2 1/8	4 5/8	11 1/2	2.15
E	Portable "B"	P-67		67 1/2		12	2 5/8	1 3/8	3 11/16	10	2.45
A	Portable "B"	P-45	4 1/2	45		6	39 1/8	1 3/4	5 1/2	12	2.15
D	Portable	P-361	7 1/2	90		6	9 1/2	2 1/4	3 3/4	24	5.25

BATTERIES



Use Genuine
PHILCO
PARTS

PHILCO FLASHLIGHT AND ALL-PURPOSE BATTERIES

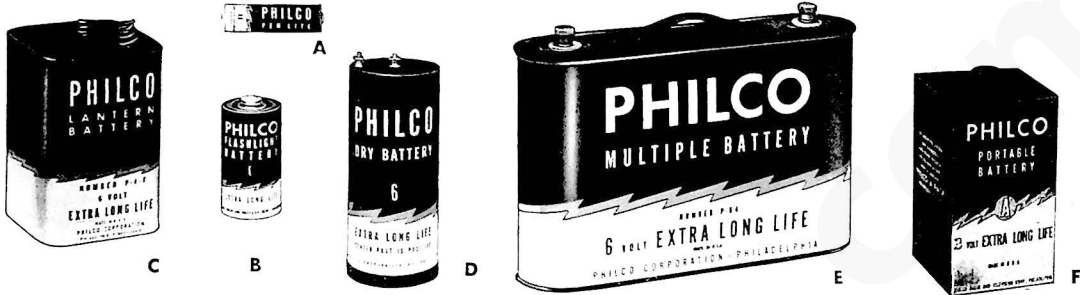

FIG.	CLASSIFICATION	TYPE	VOLTAGE	UNIT PACKAGE COUNTER DISPLAY	STANDARD PACKAGE	SIZE IN INCHES			WEIGHT IN LBS. PER STANDARD PACKAGE	LIST PRICE
						LENGTH	WIDTH	HEIGHT		
A	Penlite Wax top	"AA"	1 1/2	30	180		1/2 diameter	1 7/8	8	\$0.075
B	Baby wax top	"C"	1 1/2	12	72		1 diameter	1 7/8	8	.10
B	Heavy-duty Metal top	"D"	1 1/2	24	240		1 1/4 diameter	2 3/8	58	.10
C	Lantern	P-4-F	6		25	2 5/8	2 5/8	4	40	.70
F	Portable "A"	P4F4R	6		6	2 9/16	2 9/16	4 1/8	8 1/2	.90
D	All purpose: telephones; lanterns; bells, etc.	6	1 1/2		25		2 9/16 diameter	6 1/8	60	.65
E	Multiple	P-64	6		6	10 3/8	2 3/4	7 1/2	60	3.15

PHILCO FARM-RADIO BATTERIES

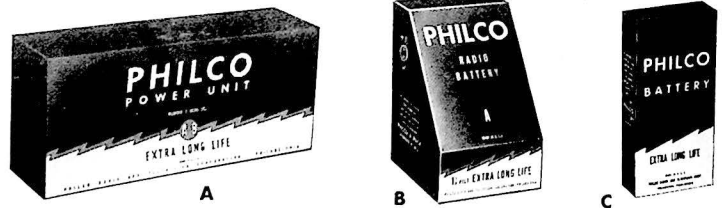

FIG.	CLASSIFICATION	TYPE	VOLTAGE			STANDARD PACKAGE	SIZE IN INCHES			WEIGHT IN LBS. PER STANDARD PACKAGE	LIST PRICE
			A	B	C		LENGTH	WIDTH	HEIGHT		
A	Radio "A-B"	P-300	7 1/2, 9	90		4	10 7/8	2 3/4	6 11/32	39	5.95
A	Radio "A-B"	P-326	7 1/2, 9	90		1	13 3/8	4 1/8	7 15/16	22	8.50
A	Radio "B"	P-602		90		1	15 7/8	3	6 7/8	15 1/2	5.00
A	Radio "A-B"	P-60D-11L	1 1/2	90		1	16	4 1/2	6 3/8	22	7.50
A	Radio "A-B"	P-60B-6L	1 1/2	90		4	10 3/4	2 3/8	6 1/4	40	5.35
B	Radio "A"	P-816	1 1/2			3	4 1/2	5 1/8	7 1/8	22 1/2	3.25
C	Radio "A-B"	P-15	1 1/2	45		6	3	15 1/16	6 1/4	9	3.50



BATTERY REPLACEMENTS FOR PHILCO FARM RADIOS
SEPARATE "A" AND "B" TYPES "A-B" PACK TYPES

PHILCO MODEL	CORRECT PHILCO "A" BATTERY	CORRECT PHILCO "B" BATTERY
30	1-P8024	4-P30FL, P30F, or P30D
35	1-P8024	1-P5B "C" 1-P15B5 "C" 3-P30FL, P30F, or P30D
36	1-P8024	1-P15B5 "C" 3-P30FL, P30F, or P30D
37	1-P8024	1-P9068
38 and 38A	1-P8024	1-P9068
38-123 and 38A-123	1-P8024	1-P9068
623 and 623A	1-P8024	1-P9068
643 and 643A	1-P8024	1-P9068
37-33	1-P8024	1-P9068
37-38	1-P8024	1-P9068
37-623	1-P8024	1-P9068
37-643	1-P8024	1-P9068
38-33	1-P8024	1-P9068
38-38	1-P8024	1-P9068
38-623	1-P8024	1-P9068
38-643	1-P8024	1-P9068
39-80	1-P816	1-P602
39-85	1-P816	1-P602

PHILCO MODEL	CORRECT PHILCO "A-B" PACK (Use 1)
39-70	P60D11L
39-75	P60D11L
40-90	P60D11L
40-95	P60D11L
40-100	P60D11L
40-105	P60D11L
40-110	P60D11L
41-90	P60B6L
41-95	P60D11L
41-100	P60D11L
41-105	P60D11L
41-110	P60D11L
41-RP5	P15
42-121	P60B6L
42-122	P50D11L
42-123	P60D11L
42-124	P60D11L
42-125	P60D11L
46-126	P6CD11L
46-131	P60B6L
46-132	P60D11L
46-133	P60D11L
46-134	P60D11L
46-142	P60B6L
48-141	P60B6L
48-150	P60D11L
49-100	P60B6L
49-101	P300 or P326

BATTERY REPLACEMENTS FOR PHILCO PORTABLE RADIOS
SEPARATE "A" AND "B" TYPES "A-B" PACK TYPES

PHILCO MODEL	CORRECT PHILCO "A" BATTERY	CORRECT PHILCO "B" BATTERY
39-71	1-P94	2-P305
39-72	1-P94	2-P305
39-73	1-P94	2-P305
39-74	1-P94	2-P305
40-74	1-P94	2-P305
40-504	1-P94	2-P305
41-842	2-P100	2-P200
41-843	2-P100	2-P200
41-844	2-P100	2-P200
42-842	2-P100	2-P200
42-843	2-P100	2-P200
42-844	2-P100	2-P200
42-853	2-P100	2-P200
42-854	2-P100	2-P200

PHILCO MODEL	CORRECT PHILCO "A-B" PACK (Use 1)
40-81	P41A4FL
40-82	P41A4FL
40-83	P41A4FL
40-88	P60A4L
40-PT-63	P41A4FL
41-81	P41A4G
41-83	P41A4G
41-84	P60A8F4
41-85	P60A8F4
41-89	P89
41-841	P841A
41-851	P841A
41-PT-87	P87
41-PT-88	P87
42-PT-87	P87
42-PT-88	P87
46-350	P841A
48-300	P841A
48-360	P841A
48-601	P361
48-602	P361
49-601	P361
49-602	P361
49-605	P841A
49-607	P841A

BATTERIES



Use Genuine
PHILCO
PARTS

PHILCO BATTERIES REPLACE BATTERIES OF OTHER MAKES

PHILCO	ACME	ADMIRAL	ADVANCE	AIR-CASTLE	BOND	BRIGHT STAR	BURGESS	CROSLY	EVEREADY	GAMBLE	GENERAL
P15B-5				1481	1517	15-03	5156PI	CR81	768		H15B-5
P9068				1500	9926	90-06	F90-D6				90FL6D
P968					9928	90-08					90FL-8D
P89											40CW2CF
P41A4FL			41AD7	1530			4GMA41	CR49		AB669	41A4FL
P87							5GMA42				42A5G5
P60A4L			837	1531			6FMA60			AB667	60A4L
P841A		AB-50		1532			F6A60	CR68	753		60A6F6/5
P60B6F6				1533			G6B60				Z60B6H6
P60B6L				1490				CR69			60B6L
P60D11L	782	AB-48		1491	0528	61-05	17GD60	CR60	758	Z42-273	60DL11L
AA					103	59-1	Z	CR84	915	17-448	AA
C					101	11-M	1		935	17-425	C
D		F-2	2-11B	1514	102	10-M	2	CR85	950	17-430	D
P4F					123	460	F4H		409	17-440	V4F
D Ind					902	10MC	#2 Ind		1050		D Ind
#6			#6		#6	#6 Ignitor		CR82	#6 Ignitor	17-410	#6 Ignitor
#6			#6		#6	#6-A	4FA	CR82	7111		#6 A
#6					#6RR						#6 Ind
#6 Tel					#6 Tel	#6 Tel	4FJ		#6 Col'bia		#6 Tel
P64			46		5141	146	4F4H	CR83	1461	17-415	64I
P4L1											4L1-S
P94	114	A-42	247	1510	4826	462	4F	CR59	742	Z42-263	4F1
P8F1					4829	860	8F		741		8F1
P8024				1460	6140	40-60	20F2	CR66	X125	68	24L-2
P100	123	A-46	647	1512	4928	361	G3	CR72	746	Z42-266	3H3
P4F4R	114S2	A-6	2476	1513		646	F4PI	CR64	744	Z42-267	4F4
P210		B-63		1520		30-55	A30	CR77		Z42-302	V30A
P200				1522			A30X	CR79		640	F30A
P305	330	B-62	267	1521		30-03	B30	CR71		Z42-301	V30B
P30D				1470	3044	30-95	2308	CR75	487	Z42-280	V30D
P30F				1471	3061	3060	10308	CR76		42-295	V30F
P30FL				1472			21308			8830	V30FL
P45	830		284	1525	6220	30-33	M30	CR87	482		W30B
P67		B-67		1523	1720		XX45	CR88	467		W45A
P3D				1480	312	7117	2370PI	CR80	X771	42-305	H3D
P5B					517	51-03	5540		773		V5B



PHILCO BATTERIES REPLACE BATTERIES OF OTHER MAKES (Cont.)

PHILCO	MARA- THON	MONT. WARD	NAT'L UNION	RAYOVAC	RCA	SEARS	USALITE	WILLARD	WIN- CHESTER	WIZARD	ZENITH
P15B-5		85	C880	P5151	VSO 31	6390	613	H15B	5216	B6320	
P9068				P8960	VSO 32			96H	9916		
P968				P8980				90H8D	9918		
P89		32						WP-4			
P41A4FL		34		AB419			AB669	WP-1		B6440	
P87		36		AB794	VSO 38						
P60A4L		31	N803	AB84	VSO 37		AB667	WP-3			
P841A		33	N808	AB994	VSO 19		60AD5	60A6F6/5		B6460	Z979
P60B6F6		37		AB677	VSO 47		AB677	WZ-3			Z985
P60B6L		59	N805	AB85	VSO 21	6303		60B6L		B6410	
P60D11L	1967	57	N801	AB82	VSO 22	6300	AB666	60DL11L	0518	B6420	Z802
AA		3252	AA	7-R	VSO 34		908	AA	1711	B6710	
C	110	3263		1LP	VSO 33		74	C	1311	B6730	
D	120	3260	D	2LP	VSO 01		75	D	1511	B6732	
P4F	490	3257		941	VSO 40		934	V4F	4812	B6760	
D Ind				2111			9951	D Ind	1011		
#6		3250		#6 Ignitor	VSO 06		#6	#6	1615		
#6		3250		1211-A	VSO 36		#6		-6	B6916	
#6											
#6 Tel				#6 Tel	VSO 42			#6 Spl	#6 Tel		
P64		3255		641	VSO 39		641	641	4615	B6928	
P4L1								4L1-S			
P94	491	21	A830	P94A	VSO 04	57N6430	634	4F1	4816	B6110	Z94A
P8F1		20		P98A	VSO 08		635	8F1	4819		
P8024		64	A840	P9403	VSO 25	05081	3AF	24L2	7818	B6125	
P100	381	24	A835	P83A	VSO 02	57N6440	683	WA31	4918	B6135	Z83A
P4F4R	496	28	A837	P694A	VSO 09	57N6451	639	WA4-2		B6145	
P210		41	B863	P430	VSO 14		621	V30A		B6228	
P200		44	B861	BB30P				WB6			
P305	3050	49	B860	P5303	VSO 12	6462	624	V30B	6218	B6239	Z530
P30D	230	70	B850	P5233	VSO 26	05091	632	V30DL	6518	B6215	
P30F	3090	73	B851	P5933	VSO 27	05095	650	V30F	6818	B6220	
P30FL		77		P9303		05152	660	V30FL	6918		
P45		42	B862	P7830	VSO 13	6461	640	WBM-1	6210	B6241	Z783
P67		43	B865	4367	VSO 16	57H6480		WBM-2	1710	B6258	Z45
P3D		83	C870	P231W	VSO 30	5005	1003	H3D	3516	B6310	
P5B	5501		C872	551	VSO 29		606	V5B	5218	D215	



BATTERY REPLACEMENTS FOR ALL PORTABLE RADIOS

MAKE	MODEL	"A" BATTERY	"B" BATTERY	"A-B" PACK (USE 1)	MAKE	MODEL	"A" BATTERY	"B" BATTERY	"A-B" PACK (USE 1)		
ADMIRAL	27-G4	2-D Cells	1-P67	AIR CASTLE (Cont'd)	591	1-P4F4R	2-P305		
	28-G5	2-D Cells	1-P67		611-1	1-P8F1	2-P305		
	29-G5	2-D Cells	1-P67		900	1-P94	2-P305		
	33-F5	P60A4L		2861	1-P94	2-P305		
	34-F5	P60A4L		2952	1-P94	2-P305		
	35-G6	P60A4L		KD	1-P4F4R	2-P305		
	36-H5	P60A4L		KD73	1-P8F1	2-P305		
	37-G6	P60A4L		TF	1-P94	2-P305		
	51-D4	P60A4L		TF1	1-P94	2-P305		
	76-P5	No Philco	2-P210		AIR CHIEF	500	1-P94	2-P305	
	76-XP5	No Philco	2-P210			S-7397-2	2-P100	2-P305	
	77-P5	No Philco	2-P210			S-7397-1	2-P100	2-P45	
	77-XP5	No Philco	2-P210			S-7426-9	No Philco	
	77P6	No Philco	2-P210			S-7426-7	No Philco	
	78P6	1-P94	2-P305			S-7426-6	No Philco	
	78XP6	1-P94	2-P305			S-7427-5	No Philco	
	79-XP6	1-P94	2-P305			S-7402-6	1-P4F4R	2-P210	
	164-4D	1-P8F1	2-P305	AIRGUIDE		TR1	No Philco	2-P45	
	231-4F	1-P94	2-P210			D4-A	No Philco	No Philco	
	231-4Z	1-P94	2-P210		BR1	2-D Cells	1-P67		
	236-5N	No Philco	2-P305		BR-D4	1-P4F4R	No Philco		
	311-4D	1-P94	2-P305		AIR KING	444	3-D Cells	1-P67	
	319-4Z	No Philco	2-P210			3905	No Philco	
	331-4F	1-P94	2-P210			3906	1-P8F1	2-P305	
	335-4Z	1-P94	2-P305			3910	1-P8F1	2-P305	
	336-5N	No Philco	2-P305			3912	No Philco	
	635-4Z	1-P94	2-P305			3916	1-P94	2-P305	
636-5N	No Philco	2-P305	3950	No Philco		2-P305			
1035-4Z	1-P94	2-P305	4012		No Philco			
1036-5N	No Philco	2-P305	4016	No Philco		2-P45			
6E1	P841A	4112	No Philco		2-P305			
AEOLIAN OR AEOLIAN HALL	BP2	No Philco	2-P45	AIR LINE (See Montgomery Ward)	ANDREA	6G61	2-P100	2-P305	
	BP3	No Philco	2-P45			6G61A	2-P100	2-P305	
	BP4	1-P94	2-P305			6G63	2-P100	2-P305	
	BP5	1-P94	2-P305			6G63A	2-P100	2-P305	
	BP6	No Philco			21AF-5	1-P94	2-P210	
	BP8	1-P4F4R	2-P305			21F-5	1-P94	2-P210	
	BP10	1-P4F4R	2-P305			UF51	1-P8F1	2-P305	
	BP36	2-P100	2-P45			P163	2-P100	2-P45	
BP943	No Philco	ARCADIA			4B5	1-P8F1	2-P305	
AEROVOICE	D4	1-P4F4R	No Philco				5B3	1-P8F1	2-P305
	TR1	No Philco	2-P45		ARIA	O-551	1-P4F4R	2-P305	
AETNA	All Models	1-P4F4R	2-P305			4B5	1-P8F1	2-P305	
	AIR CASTLE	1BR50	1-P4F4R		2-P305		5B3	1-P8F1	2-P305
4D		1-P94	2-P305			AIR CASTLE (Cont'd)	591	1-P4F4R	2-P305
5N		No Philco	2-P305				611-1	1-P8F1	2-P305
18		1-P94	2-P305				900	1-P94	2-P305
130		1-P94	2-P305				2861	1-P94	2-P305
178		1-P94	2-P305				2952	1-P94	2-P305
553		1-P94	2-P305	KD			1-P4F4R	2-P305	
554		1-P94	2-P305	KD73			1-P8F1	2-P305	
560-1		1-P8F1	2-P305	TF	1-P94		2-P305		
561-1		1-P8F1	2-P305	TF1	1-P94		2-P305		
561-1M	1-P8F1	2-P305								



BATTERY REPLACEMENTS FOR ALL PORTABLE RADIOS (Cont.)

MAKE	MODEL	"A" BATTERY	"B" BATTERY	"A-B" PACK (USE 1)	MAKE	MODEL	"A" BATTERY	"B" BATTERY	(USE 1) "A-B" PACK	
ARLINGTON	4B5	1-P8F1	2-P305	BLACK HAWK	4B5	1-P8F1	2-P305	
	5B3	1-P8F1	2-P305		5B3	1-P8F1	2-P305	
	O-551	1-P4F4R	2-P305	CARRYETTE	WR-675	1-P8F1	2-P305	
ARVIN	802	No Philco	2-P45	CARRYOLA	BP4	1-P94	2-P305	
	803	No Philco	2-P45		BP5	1-P94	2-P305	
	820	No Philco	2-P45	CHEVROLET	985514	1-P8F1	2-P305	
	822	No Philco	2-P45		CLARION	0-53	1-P4F4R	2-P305
	140-T	P841A			0-461	P60A4L
AUTOCRAT	90	1-P94	2-P305	0-464		No Philco	2-P45	
	98	1-P94	2-P210	0-531		1-P4F4R	2-P45	
	120	1-P8F1	2-P305	0-532		1-P4F4R	2-P45	
	131	1-P4F4R	2-P305	0-533		1-P4F4R	2-P45	
	132	1-P4F4R	2-P305	0-534		1-P4F4R	2-P45	
	161	1-P94	2-P210	0-535		1-P4F4R	2-P45	
	531	No Philco	1-53		1-P4F4R	2-P45	
533	No Philco	1-536	1-P4F4R		2-P45		
AUTOMATIC	P30	2-D Cells	1-P45	1-541	1-P4F4R	2-P45		
	P33	2-D Cells	1-P45	B-539	1-P4F4R	2-P45		
	P40	No Philco	2-P45	B-543	1-P4F4R	2-P45		
	P41	No Philco	2-P45	1-532	1-P4F4R	2-P45		
	P43	1-P94	2-P305	1101	P60A4L			
	P45	1-P94	2-P305	(See also "Troubador")			
	P50	No Philco	2-P45	CLARK	457	1-P94	2-P305	
	P51	No Philco	2-P45		948	1-P8F1	2-P305	
	P57	1-P94	2-P305		949	1-P8F1	2-P305	
	P58	1-P94	2-P305		CLIMAX OR GENERAL TELEVISION	473	1-P94	2-P210
	P60	4-D Cells	2-P45			561	1-P94	2-P305
	P61	1-P94	2-P305	568		1-P94	2-P305	
	P72	1-P94	2-P305	578B		1-P4F4R	2-P305	
	P80	No Philco	2-P45	578		1-P4F4R	2-P305	
	P81	No Philco	2-P45	507		1-P4F4R	2-P305	
	Tom Thumb	1-D Cell	1-P45	507L		1-P4F4R	2-P305	
	Tom Thumb DeLuxe	1-D Cell	1-P45	509		1-P4F4R	2-P305	
	Tom Thumb 3 Way	3-D Cells	1-P67	512		1-P4F4R	2-P305	
	Tom Thumb 3-in-1	5-C Cells	1-P67	512PB		1-P4F4R	2-P305	
	Personal	5-C Cells	1-P67	575		1-P94	2-P305	
BELMONT	403	1-P8F1	2-P305	592		1-P4F4R	2-P305	
	407	No Philco	2-P210	536		2-P100	2-P45	
	460	1-P8F1	2-P305	611		2-P100	2-P305	
	507	1-P4F4R	2-P210	73	2-P100	2-P210		
	509	1-P4F4R	2-P305	23A6	P60A4L			
	511	1-P8F1	2-P305	COLONIAL	553	1-P8F1	2-P305	
	513	1-P4F4R	2-P210		575	1-P8F1	2-P305	
	553	1-P8F1	2-P305		985514	1-P8F1	2-P305	
	590	1-P4F4R	2-P210		563	1-P4F4R	2-P305	
	5P110	P841A		GM985775	1-C Cell	1-P67	
	5P111	No Philco	COLUMBIA	164	1-P94	2-P305	
	5P113	No Philco		CORONADO	4B5	1-P8F1	2-P305
	5P19	1-P4F4R	2-P210	5B3		1-P8F1	2-P305	
BENDIX	687-A	No Philco	568		1-P94	2-P305	
	Par-80-Marine	No Philco	IF456KC		1-P94	2-P305	
	Par-3	1-P94	1-P67	CS90		1-P4F4R	2-P210	
BESTONE	D-115	No Philco	2-P45	6B7		2-P100	2-P305	
	PT-50	1-P4F4R	2-P305	6B10	2-P100	2-P305		
	PT-51	1-P4F4R	2-P305						
	PQ-61	2-P100	2-P45						

BATTERIES



Use Genuine
PHILCO
PARTS

BATTERY REPLACEMENTS FOR ALL PORTABLE RADIOS (Cont.)

MAKE	MODEL	"A" BATTERY	"B" BATTERY	"A-B" PACK (USE 1)	MAKE	MODEL	"A" BATTERY	"B" BATTERY	"A-B" PACK (USE 1)	
CORONADO (Cont.)	6B16	2-P100	2-P305	DETROLA (Cont.)	3602	2-P100	2-P45	
	6B18	2-P100	2-P305		3603	2-P100	2-P45	
	6P11	2-P100	2-P305		591	P841A	
	2543	No Philco		592	1-P94	No Philco	
CROSLEY	429A	1-P8F1	2-P305	DEWALD	408	1-P8F1	2-P305	
	B439A	P41A4FL		408R	1-P8F1	2-P305	
	5549	1-P94	2-P305		409	1-P94	2-P305	
	27BD	1-P4F4R	2-P305		Companionette No. 410	415	3-D Cells	1-P67
	27BE	1-P4F4R	2-P305			415R	No Philco
	45BV	1-D Cell	1-P67			415RA	1-P94	2-P305
	549	P41A4FL			544	1-P4F4R	2-P305
	549A	P41A4FL			544L	1-P4F4R	2-P305
	549B	P41A4FL			545	No Philco	2-P45
	B429A	1-P8F1	2-P305			545LW	No Philco	2-P45
	45CC	1-D Cell	1-P67			545SW	No Philco	2-P45
	52PA	No Philco			564	2-D Cells	1-P67
	52PB	No Philco			565	No Philco	2-P45
	56PA	No Philco	2-P210		A507	2-P100	2-P45	
	56PB	No Philco	2-P210		ECA	204	2-P100	2-P45
	63PA	2-P100	2-P305		ELECTRO- MATIC	PG5	1-D Cell	1-P67
	63PB	2-P100	2-P305						
	63FB	2-P100	2-P305						
	66PA	2-P100	2-P305						
	B449A	1-P94	2-P305	EMERSON	33	2-P100	2-P45	
	B459A	1-P94	2-P305		34	2-P100	2-P45	
	B579A	1-P94	2-P305		302	2-P100	2-P45	
	B589A	1-P94	2-P305		338	2-P100	2-P45	
	5509	1-P94	2-P305		339	2-P100	2-P45	
B5579M	1-P94	2-P305	340		2-P100	2-P45		
B5589M	1-P94	2-P305	341		2-P100	2-P45		
B6579D	1-P94	2-P305	357		2-P100	2-P45		
CRUZAIR	PT-50	1-P4F4R	2-P305		357A	2-P100	2-P45	
	PT-51	1-P4F4R	2-P305		363	2-P100	2-P45	
	PQ-61	2-P100	2-P45		379	3-D Cells	1-P67	
DELCO	RC527E	1-P94	2-P45		380	3-D Cells	1-P67	
	RC-562	2-P100	2-P45		385	2-P100	2-P45	
	R1400	1-P8F1	2-P305		389	2-P100	2-P45	
	R1401	No Philco	2-P210		390	2-P100	2-P45	
	R1402	No Philco	2-P210		401	2-P100	2-P45	
	R1405	1-P94	2-P45		402	2-P100	2-P45	
	R1406	1-P94	2-P45		424	2-P100	2-P45	
	P1407	2-P100	2-P45		427	2-P100	2-P45	
	DETROLA	282	1-P94	No Philco		428	2-P100	2-P45
286		1-P8F1	2-P305		430	3-D Cells	1-P67	
288		1-P8F1	2-P305		432	3-D Cells	1-P67	
289		1-P94	2-P305		448	3-D Cells	1-P67	
295		1-P94	2-P305	CE259	1-P94	2-P305		
299		1-P94	2-P305	CE263	1-P8F1	2-P305		
303		P41A4FL	CT275	1-P8F1	2-P305		
339		2-P100	2-P45	CX263	1-P8F1	2-P305		
340		2-P100	2-P45	CX283	1-P8F1	2-P305		
341		2-P100	2-P45	CX284	1-P8F1	2-P305		
360		2-P100	2-P45	CX292	1-P8F1	2-P305		
372		3-D Cells	1-P67	CX305	1-P8F1	2-P305		
378		3-D Cells	1-P67	CX308	1-P8F1	2-P305		
378-1		3-D Cells	1-P67	DC308	1-P8F1	2-P305		
378-2		3-D Cells	1-P67	DF302	2-P100	2-P305		
383		1-P4F4R	2-P210	DF306	2-P100	2-P45		
389-1		2-P100	2-P45	DJ310	2-P100	2-P45		
3401		2-P100	2-P45	DJ311	2-P100	2-P45		
3412		2-P100	2-P45	DJ312	2-P100	2-P45		
3601		2-P100	2-P45	DU379	3-D Cells	1-P67		



BATTERY REPLACEMENTS FOR ALL PORTABLE RADIOS (Cont.)

MAKE	MODEL	"A" BATTERY	"B" BATTERY	"A-B" PACK (USE 1)	MAKE	MODEL	"A" BATTERY	"B" BATTERY	"A-B" PACK (USE 1)	
EMERSON (Cont.)	DU380	3-D Cells	1-P67	FADA (Cont.)	P70	1-P8F1	2-P45	
	EA312	2-P100	2-P45		PL70	No Philco	2-P45	
	EA338	2-P100	2-P45		80	2-D Cells	1-P67	
	EA1-341	2-P100	2-P45		82	2-P100	2-P200	
	EE340	2-P100	2-P45		P80	2-D Cells	1-P67	
	EF363	2-P100	2-P45		P82	2-P100	2-P45	
	FF411	3-D Cells	1-P67		FARN- WORTH	AT30	1-P94	No Philco
	EA339	2-P100	2-P45			AT31	1-P4F4R	2-P305
	EA357	2-P100	2-P45	BT58		P60A4L	
	EA357-A	2-P100	2-P45	BT68		
	EA385	2-P100	2-P45	CT59		3-D Cells	1-P67	
	EA389	2-P100	2-P45	CT60		No Philco	2-P210	
	EA402	2-P100	2-P45	CP350		5-D Cells	1-P67	
	EE390	2-P100	2-P45	FIDELITONE	4B5	1-P8F1	2-P305	
	EE401	2-P100	2-P45		5B3	1-P94	2-P305	
	EF424	2-P100	2-P45		FIRESTONE	See "Air Chief"			
	EF427	2-P100	2-P45	GALVIN MFG. CO.		5A1	3-D Cells	1-P67
	EF428	2-P100	2-P45		5A5	5-D Cells	1-P67	
	DU441	2-D Cells	1-P67		65L2	2-P100	2-P45	
	508	2-D Cells	1-P67		(See also Motorola)				
536	2-P100	2-P45	GAROD	BP4	1-P94	2-P305		
ENDURANCE	282	1-P94	2-P210		BP5	1-P94	2-P305	
	ESPEY	040	1-P8F1		2-P305	BP5A	1-P94	2-P305
		050	1-P4F4R		2-P305	BP6	No Philco
		051	1-P4F4R		2-P305	BP7	1-P94	2-P305
		052	1-P4F4R		2-P305	BP8	No Philco
		053	No Philco		2-P45	BP9	1-P4F4R	2-P210
		942		No Philco	BP10	1-P4F4R	2-P210
		942A		No Philco	BP11	2-P100	2-P45
		942C		No Philco	BP12	No Philco	2-P305
		942F		No Philco	BP12A	No Philco	2-P305
		942P		No Philco	BP12B	No Philco	2-P305
		943		No Philco	BP12Q	2-P100	2-P45
		958		No Philco	BP15	2-P100	2-P45
		964		No Philco	BP20	3-D Cells	1-P67
		965		No Philco	BP24	2-P100	2-P45
		FADA	B33		3-D Cells	1-P67	BP25	2-P100	2-P45
C33			3-D Cells	1-P67	BP27	1-P100 & 1-P4F4	2-P45	
C34	3-D Cells		1-P67	BP28	1-P100 & 1-P4F4	2-P45		
L33	3-D Cells		1-P67	BP29	1-P100 & 1-P4F4	2-P45		
M33	3-D Cells		1-P67	BP36A	2-P100	2-P45		
P22	No Philco		2-P45	BP118	1-P4F4R	2-P305		
P23	No Philco		2-P45	BP307	2-P100	2-P45		
P24	1-P94		2-P305	BP308	2-P100	2-P45		
P28	No Philco		2-P45	BP309	2-P100	2-P45		
P40	1-P8F1		2-P305	BP310	2-P100	2-P45		
P41	2-P100		2-P305	BP37	2-P100	2-P210		
P47	1-P94		2-P305	BP38	2-P100	2-P210		
P49	1-P94		2-P305	SD1-2-3	5-D Cells	1-P67		
P58	1-P94		2-P305	GENERAL ELECTRIC	GB400	1-P8F1	2-P305	
PD22	No Philco		2-P45		GB401	1-P8F1	2-P305	
PD28	No Philco		2-P45		GB402	1-P94	No Philco	
PD40	1-P8F1		2-P305		GB440	1-P94	2-P305	
PD47	1-P94		2-P305		HB401	1-P8F1	2-P305	
PD49	1-P94		2-P305		HB402	1-P94	No Philco	
P49SW	1-P94		2-P305		HB403	1-P94	No Philco	
PD49SW	1-P8F1		2-P305		HB408	1-P8F1	2-P305	
PL22	No Philco		2-P45		HB410	No Philco	2-P45	
PL24	1-P8F1		2-P45		HB411	No Philco	2-P45	
PL40	1-P8F1		2-P305						
PL41	2-P100		2-P45						
PL58	1-P94		2-P305						
P72	1-P8F1		2-P305						
PL72	1-P8F1		2-P305						



BATTERY REPLACEMENTS FOR ALL PORTABLE RADIOS (Cont.)

MAKE	MODEL	"A" BATTERY	"B" BATTERY	"A-B" PACK (USE 1)	MAKE	MODEL	"A" BATTERY	"B" BATTERY	"A-B" PACK (USE 1)
GENERAL ELECTRIC (Cont.)	HB412	No Philco	2-P45	KARNS-WHITE	400	6-D Cells	2-P305
	HB504	1-P4F4R	2-P305		805	6-D Cells	2-P305
	HB505	1-P4F4R	2-P305		DF	2-P100	2-P45
	HBX467	1-P94	No Philco	KENNEDY	1-P94	2-P305
	JB410	3-D Cells	1-P67		KNIGHT	SN	No Philco	2-P305
	JB513	No Philco	2-P45	SNL		No Philco	2-P305
	JB508	No Philco	2-P45	A10700		P60A4L
	JB514	No Philco	2-P45	A10701		P60A4L
	JB523	No Philco	2-P45	A10725		P60A4L
	JB524	No Philco	2-P45	A10730		3-D Cells	No Philco
	JB630	2-P100	2-P45	A10748		No Philco
	JB631	2-P100	2-P45	A10761		No Philco	2-P45
	LB412	3-D Cells	1-P67	A10795		1-P8F1	2-P305
	LB502	2-D Cells	1-P67	A10826		No Philco
	LB603	3-D Cells	1-P67	A10848		1-P94	2-P305
	LB612	3-D Cells	1-P67	A10855		No Philco	2-P305
	LB641	3-D Cells	1-P67	A10872		1-P8F1	2-P305
	LB642	3-D Cells	1-P67	A10873		1-P4F4R	2-P305
	LB700	2-P100	2-P45	A10889		1-P94	2-P305
	LB701	2-P100	2-P45	B10505		3-D Cells	No Philco
LB702	2-P100	2-P45	B10506	3-D Cells		No Philco	
LB703	2-P100	2-P45	B10521	1-P4F4R		2-P210	
LB673	2-P100	2-P45	B10522	1-P4F4R		2-P210	
				B10523	1-P4F4R		2-P210	
				B10524	1-P4F4R		2-P210	
GENERAL TELEVISION	See Climax				B10540		P60A4L
GILFILLAN	4B	1-P94	2-P305	B10545		P60A4L
	4C	1-P94	2-P45	B10562		2-P100	2-P45
	5B	1-P94	2-P305	B10563		2-P100	2-P45
	6B	2-P100	2-P305	B10564		2-P100	2-P45
	5L	P841A	B10565		2-P100	2-P45
	66B Series	P841A	B10595	1-P8F1	2-P210	
GLORITONE	33F5	1-P94	2-P305	B10600	3-D Cells	1-P67	
	33G5	1-P94	2-P305	B10606	3-D Cells	1-P67	
	B3466	1-P94	2-P305	B17107	3-D Cells	1-P67	
	B33FS	1-P94	2-P305	B17108	3-D Cells	1-P67	
					B17109	1-P8F1	2-P210	
GREBE	See Garod				B17111	No Philco	2-P45	
	GRIFFITH	4B5	1-P8F1	2-P305	B17112	No Philco	2-P45
		5B3	1-P94	2-P305	B17115	1-P8F1	2-P210
	HAMILTON	606	2-P100	2-P45	B17131	3-D Cells	No Philco
						B17132	3-D Cells	1-P67
					B17133	3-D Cells	1-P67	
					B17134	3-D Cells	1-P67	
					D155	3-D Cells	1-P67	
HOFFMAN	A700	P841A	D156	3-D Cells	1-P67	
					D157	3-D Cells	1-P67	
HOWARD	10B	1-P8F1	2-P305	D160	No Philco	
	11B	No Philco	2-P45	D161	No Philco	
	14ACB	2-P100	2-P45	D162	1-P8F1	2-P210	
					D165	1-P8F1	2-P210	
HUDSON	4B5	1-P8F1	2-P305	E10061	1-P8F1	2-P305	
	5B3	1-P94	2-P305	E10715	No Philco	
					E10716	No Philco	
IMPERIAL	PT50	1-P4F4R	2-P305	E10755	P60A4L	
	PT51	1-P4F4R	2-P305	E10756	P60A4L	
	PQ-61	2-P100	2-P45	E10757	1-P4F4R	2-P305	
					E10758	1-P8F1	2-P305	
					E10775	1-P94	2-P305	
					E10777	1-P94	2-P305	
KADETTE	L-34	No Philco	2-P45	E10826	No Philco	
					E10925	No Philco	
					N2812	1-P4F4R	2-P305	
					N2870	
KARADIO	905	4-D Cells	2-P305	N2871	P60A4L	
					D-366	2-P100	2-P305	

BATTERY REPLACEMENTS FOR ALL PORTABLE RADIOS (Cont.)

MAKE	MODEL	"A" BATTERY	"B" BATTERY	"A-B" PACK (USE 1)	MAKE	MODEL	"A" BATTERY	"B" BATTERY	"A-B" PACK (USE 1)	
KNIGHT (Cont.)	D367	2-P100	2-P305	MACY	4B5	1-P8F1	2-P305	
	E17015	No Philco		BP7	1-P94	2-P305	
	PL29	No Philco		BP9	1-P4F4R	2-P210	
	XL28	No Philco		BP10	1-P4F4R	2-P210	
	178BL	1-P94	2-P305		5B3	1-P94	2-P305	
	171AS	1-P94	2-P305	MAGNAVOX	41	1-P94	2-P305	
	5B171	2-P100	2-P45		10	1-P94	2-P305	
	6B127	2-P100	2-P45	MAJESTIC	1BR50BP	1-P4F4R	2-P45	
LA FAYETTE	A221	No Philco	2-P305		5BD	No Philco	2-P210	
	BB70	1-P8F1	2-P305		5ULBD	No Philco	2-P210	
	BB73	2-P100	2-P305		6P1	P841A	
	BP7	1-P94	2-P305		GI-426	2-P4FR	2-P305	
	BS33	1-P94	2-P305		130U	1-P94	2-P305	
	BS33A	No Philco	2-P305		420P	1-P94	2-P305	
	BS56	1-P8F1	2-P305		421	1-P94	2-P305	
	BS72	1-P94	2-P305		430PL	1-P94	2-P305	
	BS85	1-P94	2-P305		431	1-P94	2-P305	
	CC55	1-P94	2-P305		546BD	No Philco	2-P210	
	CC55A	1-P94	2-P305		420PL	1-P4F4R	2-P305	
	CC58	2-P100	2-P45		1BR50B	1-P4F4R	2-P45	
	CC58A	2-P100	2-P45		7P420	P841A	
	CC72	No Philco	2-P305		MANCO	D110	No Philco	2-P45
	E6	1-P8F1	2-P305	D111		No Philco	2-P45	
	E72	1-P8F1	2-P305	D112		No Philco	2-P45	
	E80	1-P4F4R	2-P305	MANTOLA		460	No Philco
	E92	No Philco	2-P45		R419	1-P94	2-P305	
	E94	1-P4F4R	2-P305		R419B	1-P94	2-P305	
	S50	1-P94	2-P45		MASON FLYWEIGHT	47-1BP	P841A
	T56	No Philco	2-P305	JOHN MECK		SD7/WL18	5-D Cells	2-P45
	E191	2-D Cells	1-P67			MEISNER	10-1187	1-P94	2-P305
	EB164	2-D Cells	1-P67	10-1189	2-P100		2-P210	
	S161	2-D Cells	1-P67	10-1140	2-P100		2-P210	
	JS114	3-D Cells	1-P67	12-1031	2-P100		2-P210	
	JS115	3-D Cells	1-P67	MIDWEST	39P5	1-P4F4R	2-P305	
	D93	1-P4F4R	2-P305		40P5	1-P4F4R	2-P305	
	C116	2-P100	2-P45		41P5	1-P4F4R	2-P305	
	C121	2-P100	2-P45		51BT	1-P94	2-P305	
	C125	2-P100	2-P45	MISSION BELL	400	1-P94	2-P305	
	CC58B	2-P100	2-P45		500	1-P94	2-P305	
	E193	No Philco	2-P45		501	1-P94	2-P305	
C160	No Philco	2-P45	502		No Philco	2-P45		
JS130	No Philco	2-P45	503		1-P94	2-P305		
LA FRANCE	4B5	1-P8F1	2-P305		504	1-P4F4R	2-P305	
	5B3	1-P94	2-P305		505	No Philco	2-P210	
	6B7	2-P100	2-P305		506	2-P100	2-P45	
LAUREL	4B5	1-P8F1	2-P305	508	5-D Cells	1-P67		
	5B3	1-P94	2-P305	MONROE	4B5	1-P8F1	2-P305	
LEARADIO	APRA	No Philco	2-P210		5B3	1-P94	2-P305	
	No. 6620	P841A		MONTGOMERY WARD	403	1-P94	2-P305
	No. 671	P841A			407	No Philco	2-P210
	RM402-C	P841A	438		P89	
	RM402-A	No Philco	2-P210	454		1-P94	2-P305	
RM402-B	No Philco	2-P210	460	1-P94		2-P305		
LIBERTY-PHONE	BE	No Philco	461		No Philco	2-P210	
	L'TATRO	819	1-P94	2-P305		462	1-P94	2-P210
1000		1-P94	2-P210						
S1000		10-D Cells	No "B"						



BATTERY REPLACEMENTS FOR ALL PORTABLE RADIOS (Cont.)

MAKE	MODEL	"A" BATTERY	"B" BATTERY	"A-B" PACK (USE 1)	MAKE	MODEL	"A" BATTERY	"B" BATTERY	"A-B" PACK (USE 1)		
MONTGOMERY WARD (Cont.)	464	No Philco	2-P210	MUSIC-AIRE	590-1A	1-P4F4R	2-P305		
	538	P89		NATIONAL UNION	G613	2-P100	2-P45	
	555	1-P94	2-P305			NOBLITT SPARKS	802	1-P8F1	2-P45
	565	1-P94	2-P305		803		1-P8F1	2-P45	
	566	1-P4F4R	2-P210		822		1-P8F1	2-P45	
	569	1-P4F4R	2-P210		OLYMPIC		PT50	1-P4F4R	2-P305
	573	No Philco				PT-51	1-P4F4R	2-P305
	663	2-P100	2-P305			PQ-61	2-P100	2-P45	
	668	2-P100	2-P305			6-606	2-P100	2-P45	
	672	2-P100	2-P210			PACKARD BELL	40	1-P94	2-P305
	680	P841-A		40A		1-P4F4R	2-P210	
	683	P841-A		40B		1-P4F4R	2-P210	
	684	P841-A		41		P60A4L	
	690	P841-A		54		P41A4FL	
	1050	P89		54A		P41A4FL	
	1051	No Philco		56		No Philco	2-P45	
	1052	P841-A		56A		P41A4FL	
	1054	P841-A		57		No Philco	2-P45	
	1438	P89		57A		P41A4FL	
	1455	1-P94	2-P305		PHILCO	39-71	1-P94	2-P305	
	1460	1-P94	2-P305			39-72	1-P94	2-P305	
	1461	No Philco	2-P210			39-73	1-P94	2-P305	
	1462	1-P94	2-P210			39-74	1-P94	2-P305	
	1464	No Philco	2-P210			40-74	1-P94	2-P305	
	1468	1-P94	2-P305			40-81	P41A4FL	
	1538	P89			40-82	P41A4FL	
	1565	1-P8F1	2-P305			40-83	P41A4FL	
	1680	P841-A			40-88	P60A4L	
	1690	P841-A			40-504	1-P94	2-P305	
	2555	1-P94	2-P305			40-PT-63	P41A4FL	
	2565	1-P8F1	2-P305			41-81	P41A4G	
	2566	1-P4F4R	2-P210			41-83	P41A4G	
	2569	1-P4F4R	2-P210			41-84	P60A8F4	
	2573	No Philco			41-85	P60A8F4	
2663	2-P100	2-P305	41-89	P89			
2668	2-P100	2-P305	41-841	P841A			
2672	2-P100	2-P305	41-842	2-P100		2-P200			
2680	P841-A	41-843	2-P100	2-P200				
2683	P841-A	41-844	2-P100	2-P200				
2684	P841-A	41-851	P841A				
2690	P841-A	41-PT-87	P87				
5019	1-P8F1	2-P305	41-PT-88	P87				
6B7	2-P100	2-P305	42-842	2-P100	2-P200				
MOTOROLA	3A5	5-D Cells	1-P67	42-843	2-P100	2-P200			
	41D1	1-P94	2-P305	42-844	2-P100	2-P200			
	41D2	1-P94	2-P305	42-853	2-P100	2-P200			
	41H	1-P94	2-P45	42-854	2-P100	2-P200			
	51D1	1-P94	2-P305	42-PT-87	P87			
	51D2	1-P94	2-P305	42-PT-88	P87			
	51F	1-P94	No Philco	46-350	P841A			
	52D1	1-P94	2-P305	48-300	P841A			
	5A1	2-D Cells	1-P67	48-360	P841A			
	5A5	5-D Cells	1-P67	48-601	P361			
	65-L11	2-P100	2-P45	48-602	P361			
	65-L12	2-P100	2-P45	49-601	P361			
	57BP	2-P100	2-P45	49-602	P361			
	57BP1	2-P100	2-P45	49-605	P841A			
	57BP2	2-P100	2-P45	49-607	P841A			
	57BP3	2-P100	2-P45	PIERCE AIRO	408	1-P94	2-P305		
	57BP4	2-P100	2-P45		PHILCO	39-71	1-P94	2-P305	
	61L11	2-P100	2-P45			39-72	1-P94	2-P305	
	61L12	2-P100	2-P45			39-73	1-P94	2-P305	
	65BP	2-P100	2-P45			39-74	1-P94	2-P305	
	65BP1	2-P100	2-P45			40-74	1-P94	2-P305	
	65BP2	2-P100	2-P45			40-81	P41A4FL	
	65BP3	2-P100	2-P45			40-82	P41A4FL	
	65BP4	2-P100	2-P45			40-83	P41A4FL	
	AT-99-22	1-P4F4R	2-P45			40-88	P60A4L	
	52D	1-P94	2-P305	40-504		1-P94	2-P305		



BATTERY REPLACEMENTS FOR ALL PORTABLE RADIOS (Cont.)

MAKE	MODEL	"A" BATTERY	"B" BATTERY	"A-B" PACK (USE 1)	MAKE	MODEL	"A" BATTERY	"B" BATTERY	"A-B" PACK (USE 1)
PILOT	AM-1351	No Philco	2-P45	RCA VICTOR (Cont.)	P5	1-P94	2-P45
	B-71	No Philco	2-P45		54B	1-D Cell	1-P67
	G-186	2-P100	2-P45		AVR102	2-P100	2-P45
	G-188	2-P100	2-P45		36BP	2-P100	2-P45
	T-71	No Philco	2-P45		RC407	1-P94	2-P305
	T-186	2-P100	2-P45		RC410	1-P94	2-P305
	T-187	2-P100	2-P45		RC455	No Philco	2-P45
	T-188	2-P100	2-P45		RC465	1-P94	2-P45
	T-1021	1-P94	2-P210		RC527	1-P94	2-P45
	T-1351	No Philco	2-P45		RC527A	1-P94	2-P45
	T-1451	1-P8F1	2-P305		RC527D	1-P94	2-P45
	T-1452	1-P8F1	2-P305		RC544	3-D Cells	1-P67
	T-1453	No Philco	2-P45		RC559	2-P100	2-P45
	TH-11	1-P94	2-P305		58B	1-D Cell	1-P67
	TH-12	1-P94	2-P305		66BX	P841A
	WX-1451	No Philco	2-P45					
	WX-1452	No Philco	2-P45					
	X-1351	No Philco	2-P45	REMLER	92	1-P94	2-P305
	X-1451	No Philco	2-P45		93	No Philco
	X-1452	No Philco	2-P45		94	No Philco
	X-1453	No Philco	2-P45		95	No Philco
	X-1450	No Philco	2-P305		440	4-D Cells	1-P67
	T-570	2-P100	2-P45					
PLYMOUTH	4B5	1-P8F1	2-P305	SEARS-ROEBUCK (Silvertone)	6256	1-P94	2-P305
	5B3	1-P94	2-P305		6266	1-P94	2-P305
PORTO-MATIC	BE-27	1-P8F1	2-P305		6273	1-P94	2-P305
	UI17A	1-P94	2-P305		6274	1-P94	2-P305
	UI17C	1-P94	2-P305		6372	1-P94	2-P305
	USW17A	1-P94	2-P305		6521	2-P100	2-P305
	USW17C	1-P94	2-P305		6541	1-P94	2-P305
	BE-27A	1-P94	2-P305		6551	No Philco	2-P45
	BE-27SC	1-P94	2-P305		6561	2-P100	2-P305
	BE-27R	1-P94	2-P305		6621	2-P100	2-P305
RADIETTE	4B5	1-P8F1	2-P305		6641	3-D Cells	1-P67
	5B3	1-P94	2-P305		6651	1-P94	2-P305
RADIO PRODUCTS	4D	1-P8F1	2-P305	6661	2-P100	2-P305	
					6721	2-P100	2-P305	
RADOLEK	17538	1-P94	2-P45	6751	No Philco	2-P45	
	17628	1-P8F1	2-P45	6761	2-P100	2-P305	
	17679	1-P94	2-P305	6821	2-P100	2-P305	
	17680	1-P94	2-P305	6861	2-P100	2-P305	
	17681	4-D Cells	2-P305	6911	No Philco	2-P45	
					6921	2-P100	2-P305	
					6951	No Philco	2-P45	
					6961	2-P100	2-P305	
RCA VICTOR	15HP Series	1-P94	2-P45	7089	2-P100	2-P305	
	25BP Series	1-P94	2-P45	7075	1-P4F4R	2-P210	
	26BP	2-P100	2-P45	7079	1-P4F4R	2-P45	
	94BP1	1-P94	2-P305	7083	2-P100	2-P305	
	94BP4	1-P94	2-P305	7814	No Philco	2-P45	
	94BP61	1-P94	2-P305					
	94BP62	1-P94	2-P305	SENTINEL	127BL	1-P94	2-P305
	94BP64	1-P94	2-P305		151BL	1-P94	2-P305
	94BP66	1-P94	2-P305		160BL	P60A4L
	94BP80	1-P94	2-P305		170BL	P60A4L
	94BP81	1-P94	2-P305		172BL	No Philco	2-P45
	96GA	1-P94	2-P305		178BL	1-P94	2-P305
	96TA	1-P94	2-P305		180XL	1-P4F4R	2-P305
	BP10	3-D Cells	1-P67		181BL	1-P94	2-P305
	BP55	No Philco	2-P45		192XL	No Philco	2-P45
BP56	No Philco	2-P45	201XL		1-P4F4R	2-P305	
BP85	No Philco	2-P45	202BL		No Philco	2-P45	
				205BL		No Philco	2-P45	
				213P		No Philco	2-P45	
				217P		2-P100	2-P45	
				219P		2-P100	2-P45	
				227P	2-D Cells	1-P67		
				247P	2-D Cells	1-P67		

BATTERIES



Use Genuine
PHILCO
PARTS

BATTERY REPLACEMENTS FOR ALL PORTABLE RADIOS (Cont.)

MAKE	MODEL	"A" BATTERY	"B" BATTERY	"A-B" PACK (USE 1)	MAKE	MODEL	"A" BATTERY	"B" BATTERY	"A-B" PACK (USE 1)	
SENTINEL (Cont.)	228P	2-P100	2-P45	SPARTON (Cont.)	571-1	1-P8F1	2-P45	
	262P	2-P100	2-P45		571-M	1-P8F1	2-P45	
	RC-181BL	1-P94	2-P305		582-1	1-P8F1	2-P305	
	RC-178BL	1-P94	2-P305		582-M	1-P8F1	2-P305	
	261P	2-P100	2-P45		590-1	1-P4F4R	2-P305	
	285P	2-P100	2-P45		591-1	1-P4F4R	2-P305	
SETCHELL-CARLSON	23	2-P94	2-P305		410	1-P8F1	2-P305	
	55	4-D Cells	2-P305		606	2-P100	2-P200	
	66	10-D Cells	No "B"	ST. REGIS	263	1-P94	2-P305	
	40	4-P94	2-P305		403	2-P100	2-P45	
SIMPLEX	1-P94	2-P210		STEWART-WARNER	02-4A1 to 9	1-P94	2-P210
			02-411 to 419	1-P94	2-P305
	05-511 to 9		No Philco	2-P45	
SKY CHIEF	209	P841A	15-5X1		No Philco	2-P45	
	212	1-P94	2-P305	15-5Y1		No Philco	2-P45	
	213	1-P94	2-P305	206GA		2-P100	2-P45	
	214	1-P94	2-P305	206GB		2-P100	2-P45	
	215	1-P94	2-P305	207CA		2-P100	2-P45	
	216	1-P94	2-P305	9007	P841A		
	217	2-P100	2-P45	STROMBERG-CARLSON	402H	1-P94	2-P45	
	218	1-P94	2-P305		P30990	1-P8F1	2-P45	
	219	2-P100	2-P45		1105	P841A	
	225	P841A	SUPREMACY	4B5	1-P8F1	2-P305	
	226	No Philco	2-P305		5B3	1-P94	2-P305	
	227	P841A	SYMPHONY	4B5	1-P8F1	2-P305	
	229	No Philco	2-P305		5B3	1-P94	2-P305	
	233	No Philco	2-P305	TELEPHONE	145	5-D Cells	1-P67	
	234	2-D Cells	1-P67		TELEX	P5	No Philco	2-P45
	235	2-D Cells	1-P67	TEMPLE-TONE		93	No Philco
	SKY HAWK	3910	1-P94	2-P305		F611	2-P100	2-P45
.....			G612	2-P100	2-P45	
SOLTER	1-P94	2-P305		G613	2-P100	2-P45	
		G515	2-P100	2-P45	
SONORA	KB73	1-P4F4R	2-P45		G521	2-P100	2-P45	
	KB75	1-P4F4R	2-P305	TRAV-LER	404	No Philco	2-P45	
	KBU73	1-P4F4R	2-P305		553	1-P94	2-P305	
	KBU75	1-P4F4R	2-P305		554	1-P94	2-P305	
	KBU168	1-P4F4R	2-P305		555	1-P94	2-P305	
	KD75	1-P4F4R	2-P305		556	1-P4F4R	2-P305	
	KG80	3-D Cells	No Philco		585	1-P94	2-P305	
	KG132	3-D Cells	No Philco		1555	1-P4F4R	2-P305	
	LP161	3-D Cells	1-P67		1556	1-P4F4R	2-P305	
	LP162	3-D Cells	1-P67		1566	1-P4F4R	2-P305	
	LP163	3-D Cells	1-P67		B52	No Philco	2-P210	
	LR147	1-P4F4R	2-P45		B70	1-P4F4R	2-P210	
	LR193	1-P4F4R	2-P210	B71	1-P4F4R	2-P305		
	PL29	No Philco	B80	1-P4F4R	2-P305		
	PL37	No Philco	B81	1-P4F4R	2-P305		
	TF39	No Philco	B82	1-P4F4R	2-P305		
	XL28	1-P94	2-P305	FB73	1-P4F4R	2-P305		
	RYM-224	P841A	T40X	2-D Cells	1-P67		
	RY-224	P841A	T40	4-D Cells	1-P67		
	WDU-233	P841A	TB503	No Philco	2-P210		
	SOUND-VIEW	305	6-D Cells	2-P305	553B	1-P94	2-P305	
		400	6-D Cells	2-P305	
510		6-D Cells	2-P305		
SPARTON	410-1	1-P8F1	2-P305		
	549-1	1-P94	2-P305		



BATTERY REPLACEMENTS FOR ALL PORTABLE RADIOS (Cont.)

MAKE	MODEL	"A" BATTERY	"B" BATTERY	"A-B" PACK (USE 1)	MAKE	MODEL	"A" BATTERY	"B" BATTERY	"A-B" PACK (USE 1)
TRAV-LER	TB512	2-P100	2-P45	WARWICK	558	1-P4F4R	2-P305
KARENOLA	TB601	2-P100	2-P45	(Cont.)	0-530, 1	1-P4F4R	2-P305
(Cont.)	FB82	No Philco	2-P45		532, 3	1-P4F4R	2-P305
						948, 9	1-P94	2-P305
TRIANGLE	1-P94	2-P305		457	1-P94	2-P305
						945	1-P8F1	2-P305
TROUBADOR	9-457	1-P94	2-P305		9-437	1-P94	2-P305
	1-531	1-P4F4R	2-P45		0-460 to 9	1-P94	2-P45
	1-533	1-P4F4R	2-P45		0-501	1-P4F4R	2-P305
	1-541	1-P4F4R	2-P45	WATERSON	1-P94	2-P305
	1-543	1-P4F4R	2-P45					
	2-541	1-P4F4R	2-P45	WELCO	4B5	1-P8F1	2-P305
	2-543	1-P4F4R	2-P45		5B3	1-P94	2-P305
	0-40	1-P94	2-P305					
	0-53	1-P4F4R	2-P45	WELLS-	4B5	1-P8F1	2-P305
	0-401	1-P94	2-P305	GARDNER	4B11	No Philco	2-P210
	0-407	1-P94	2-P305	& CO.	5B3	1-P94	2-P305
	0-411	1-P94	2-P305		5B8	1-P8F1	2-P305
	0-461	P60A4L		5B9	1-P8F1	2-P305
	0-501	1-P4F4R	2-P305		5B12	1-P4F4R	2-P210
	0-530	1-P4F4R	2-P305		6B7	2-P100	2-P305
	0-531	1-P4F4R	2-P45		6B10	2-P100	2-P305
	0-532	1-P4F4R	2-P45		6B18-3	2-P100	2-P305
	0-533	1-P4F4R	2-P305		6B16-1	P841A
	0-558	1-P4F4R	2-P305		6B16-3	2-P100	2-P305
	1-53	1-P4F4R	2-P45		6B25	2-P100	2-P305
	1-54	1-P4F4R	2-P210		5B4	1-P8F1	2-P305
	9-437	1-P94	2-P305		4B13	1-P94	2-P305
(See also Clarion)						4B19	P89
						5B20	P89
TROY	940	1-P8F1	2-P305	WESTERN	4B5	1-P8F1	2-P305
	949	1-P8F1	2-P305		5B3	1-P94	2-P305
	BP140	No Philco		Small	1-P94	2-P210
	BP550	No Philco	2-P45	WESTERN AIR	5B5	1-P8F1	2-P305
	BP554	1-P94	2-P305	PATROL	4B3	1-P94	2-P305
	BP640	1-P94	2-P305		5B3	1-P94	2-P305
	BP950	1-P4F4R	2-P305		4B5	1-P8F1	2-P305
	BP951	1-P4F4R	2-P305					
	BP952	1-P94	2-P305					
	BP953	1-P4F4R	2-P305					
WARWICK	0-400 to 7	1-P94	2-P305					
	0-411	1-P94	2-P305					

BATTERIES



Use Genuine
PHILCO
PARTS

BATTERY REPLACEMENTS FOR ALL PORTABLE RADIOS (Cont.)

MAKE	MODEL	"A" BATTERY	"B" BATTERY	"A-B" PACK (USE 1)	MAKE	MODEL	"A" BATTERY	"B" BATTERY	"A-B" PACK (USE 1)
WESTERN AUTO SUPPLY COMPANY (Wizard)	D3906 (D937)	1-P8F1	2-P305	WILCOX GAY	A73	No Philco	2-P45
	(D938)	1-P8F1	2-P305					
	D3908 (D939)	1-P94	2-P210	WINDSOR	4B5	1-P8F1	2-P305
	D3915 (D940)	No Philco	2-P305					
	D3015 (D1080)	1-P4F4R	2-P210					
	D3030 (D1081)	1-P94	2-P305					
	D3115 (D1180)	No Philco	WINGS	1-P94	2-P305
	D3130 (D1181)	1-P94	2-P305					
	D3119 (D1182)	1-P4F4R	2-P210					
	D3123 (D1183)	2-D Cells	1-P67					
	D3124 (D1184)	2-D Cells	1-P67					
	D3230 (D1281)	1-P94	2-P305					
	D3615	P841A					
	D3619	P841A					
	D3630	P841A					
D3635	P841A						
WESTING- HOUSE	WR62K1	2-P100	2-P45	ZENITH	4K400	1-P94	2-P305
	WR62K2	2-P100	2-P45					
	WR62K3	3-D Cells	1-P67					
	WR674	1-P94	2-P305					
	WR675	1-P8F1	2-P305					
	WR675A	1-P8F1	2-P305					
	WR676	No Philco	2-P45					
	WR678	No Philco	2-P45					
	WR679	No Philco	2-P45					
	WR680	2-P100	2-P45					
	WR681	2-P100	2-P45					
	WR682	3-D Cells	1-P67					
	WR682A	3-D Cells	1-P67					
	WR-6	1-P8F1	2-P305					
	RC433	1-P8F1	2-P305					
	RC455A	No Philco	2-P45					
	WR-K61	2-P100	2-P305					
	WR-K62	2-P100	2-P305					
	WR166	1-P94	2-P305					
	RC410A	1-P94	2-P305					
ZEPHYR	578	1-P4F4R	2-P305					
	583	1-P4F4R	2-P305					
	585	1-P4F4R	2-P305					
	592	1-P4F4R	2-P305					
	29G5	3-D Cells	1-P67					
	34F5	P60A4L					

FUSES

Philco fuses are designed for fast action. Accurately constructed, these fuses will protect any circuit within its current rating against overload.



PART NO.	CURRENT AMPS.	LIST PRICE
45-2113.....	.25	\$0.35
4540.....	107
45-2046.....	308
7331.....	807
5676.....	1008
45-2559.....	1405
7227.....	1508
45-2659.....	2010

STANDARD FUSE-HOLDER KIT

These metal fuse holders are 2½" long by 13/22" diameter, and are made to accommodate a 3AG fuse of these dimensions.

PART NO. OF KIT	LIST PRICE
45-1498	\$0.20



CONTENTS OF KIT

QUANTITY	PART NO.	DESCRIPTION	LIST PRICE
1	28-1269	Fuse Housing	\$0.04
1	28-1270	Male Connector03
2	27-7133	Metal Contact05
1	28-8009	Spring01
1	27-7132	Fibre Washer004
1	27-7729	Fuse Ins. Tube, per 100	1.80
1	4169	Rubber Washer012

FUSE INSULATORS

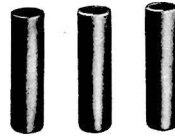

For use on automobile radio fuses. Will fit all standard ¼" diameter fuses.

PART NO.	DESCRIPTION	LIST PRICE
45-9186.....	Approximately 16 insulators.....	\$0.32
45-9186-12—Standard carton of 12 packages No. 45-9186, \$3.80		

SMALL RMA FUSE-HOLDER KIT

Metal construction. Made to accommodate the 14-ampere 3AG fuse. Dimensions are 2½" long by 1½" diameter.

PART NO. OF KIT	LIST PRICE
45-1499	\$0.20



CONTENTS OF KIT

QUANTITY	PART NO.	DESCRIPTION	LIST PRICE
1	28-5610	Fuse Housing	\$0.08
1	28-5608	Connector Cap02
2	27-4683	Bushing03
2	28-5609	Ferrule—Metal Contact	.02
1	28-8841	Spring	per 100 1.50
1	27-9049	Fibre Washer	per 100 2.50
1	4169	Rubber Washer012

IGNITION-NOISE SUPPRESSORS

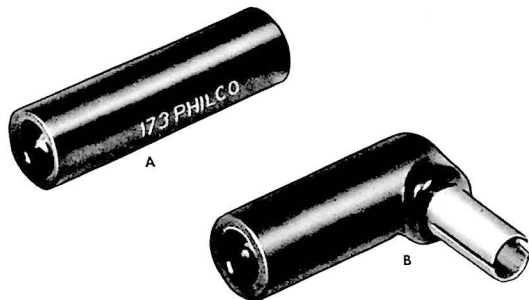

No need to endure annoying ignition noises. Philco Ignition-Noise Suppressors are designed to efficiently reduce ignition noises from any ignition system, to insure pleasant, "noise-free" radio reception. Made of only the highest-quality materials (including a moisture-proof, acid-resistant, molded-bakelite case), they are compact and easy to install.

TYPE	PART NO.	DESCRIPTION	RESISTANCE	LIST PRICE
A	33-1196	Screw-in Type	10,000 Ohms	\$0.50
B	45-1477	Elbow Type	10,000 Ohms	.45



WHEEL-STATIC ELIMINATOR

Eliminates noise interference caused by static charges built up on the front wheels of an automobile. Philco wheel-static eliminators are constructed of rugged phosphor-bronze spring material and a brass contact button, to assure good electrical contact at all times.

PART NO.	LIST PRICE
28-3584	\$0.15

AUTO-AERIAL CONNECTORS

A secure, trouble-free auto-aerial connector. Sturdily constructed and insulated with molded bakelite, the Philco Auto-Aerial Connector insures a noise-free aerial lead-in connection to your auto radio.

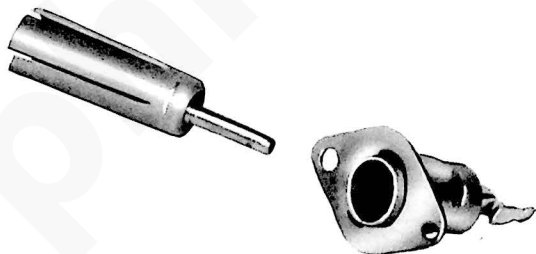

PART NO.	DESCRIPTION	LIST PRICE
57-0590	Plug	\$0.15
57-0590-1FA3	Socket	.30



FOOT-CONTROL KIT



PART NO.
45-1545

LIST PRICE
\$3.95

A sturdy foot-control-switch assembly designed as an accessory or for exact replacement in auto radios equipped for this device.

The use of the foot-control system enables 5-station selection with foot pressure alone, allowing complete driving control at all times.

Engineered for positive control and sturdy construction, the Philco foot-control switch will operate satisfactorily after 50,000 makes and breaks.

Designed for operation on a 6-volt, 12-amp. inductive load. All steel parts are rust-proofed, to insure long life under all humidity conditions.

Kit includes foot switch and cable with connector plug. Complete instructions with kit.

EXTRA-LENGTH CABLES FOR NASH CARS



Designed for use with universal radios in Nash cars, these Philco cables have a special flexible construction which minimizes backlash, for positive control.

PART NUMBER	DESCRIPTION	LIST PRICE
57-1804...	47" volume-control cable.....	\$2.15
57-1805...	49" tuning cable.....	1.90
57-1806...	47 $\frac{7}{8}$ " station-indicator cable...	2.00

UNIVERSAL REAR SEAT SPEAKER KIT

MODEL RS-3



The Universal Rear Seat Speaker Kit Model RS-3 is designed for use with any auto radio in any automobile. A brand new item to modernize any car for the utmost in pleasure driving. See page 99 for Metal Cutter for installing this kit.

Part No. 40-7606

List Price \$12.50

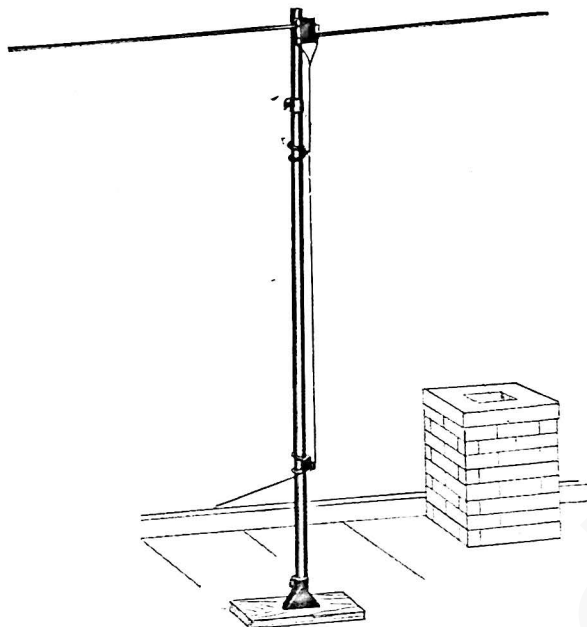

PHILCO DIPOLE AND 6-FOOT MAST

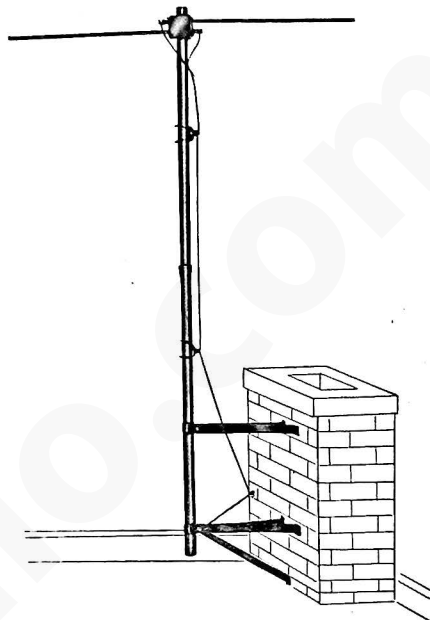

PHILCO DIPOLE AND 12-FOOT SELF-SUPPORTING MAST

PHILCO TELEVISION AERIAL-AND-MAST KITS

A brand new group of TV aerial and mast kits developed by Philco engineers and servicemen.

Ruggedly built and designed for maximum signal pickup and ease of installation, Philco television aerial and mast kits will answer practically any problem in weak signal areas, noise and reflection interferences, and installation difficulties.

The sturdy all-aluminum construction plus ingenious aerial and transmission line support assemblies provide a system that can be lifted easily with one hand, yet can withstand strong winds and bad weather.

Philco Broad-Band and High-Frequency Kits are similar, except that the former has a dipole designed for effective operation on all channels, while the latter has a dipole designed for best results on channels 7 thru 13. Mast heights to 24' may be obtained by using a Philco

12-Foot Self-Supporting Mast Kit and additional lengths of mast tubing.

Multiple Installations using 3 or 4 separate aerials on one mast are easily assembled with Philco kits.

The Philco 12-Foot Self-Supporting Mast designed to eliminate guy wires. Aerial kit, consists of 2 lengths of 6-foot, $1\frac{1}{4}$ " diameter aluminum tubing, for mounting. The tubing ends are flared for solid, force-fit joints, to permit a quick assembly. Dipole aerial rods and support assembly complete the kit. Complete instructions are supplied.

The Philco 6-Foot Guyed Mast and aerial kit consists of a 6-Foot length of $1\frac{1}{4}$ " tubing guy-wire clamps, and dipole rods with support assembly. This mast and aerial kit may be installed self-supporting or guyed. Supplied complete with instructions, but less guy wire and strain insulators.

Part No. 45-1582	Broad-Band Aerial and 6-Foot Mast Kit (45-1582-1 Kit Less Transmission Line \$9.75)	List Price \$12.25
Part No. 45-1583	Broad-Band Aerial and 12-Foot Self-Supporting Mast Kit (45-1583-1 Kit Less Transmission Line \$16.25)	List Price \$18.75

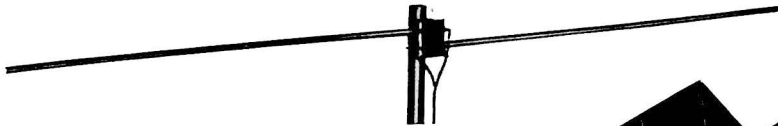

PHILCO DIPOLE AERIAL KIT

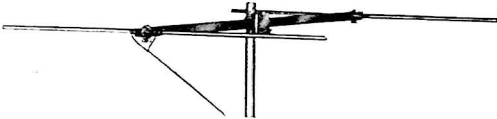

PHILCO REFLECTOR KIT
(Shown installed with Aerial Kit)

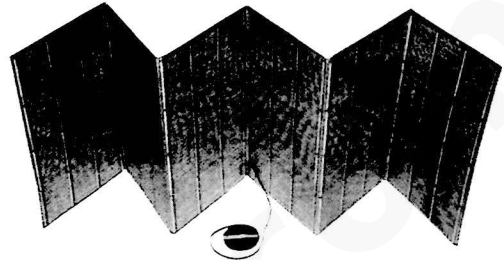

**PHILCO TELEVISION AERIAL KITS
AND REFLECTOR KITS**

Philco dipole aerials are designed for mounting on any mast of 1 1/4" diameter. Dimensions of the aluminum dipole rods are engineered for maximum effectiveness of signal pickup. The kit is supplied complete with instructions and special support assembly.

Philco reflector kits are designed for use with Philco dipole aerials and increase signal pickup and noise-elimination. Supplied complete with crossarm, necessary hardware, and instructions.

PART NO.	DESCRIPTION	LIST PRICE
45-1584	Broad-Band Aerial Kit	\$7.95
(45-1584-1)	Kit Less Transmission Line	\$5.25
45-1590	High-Frequency Aerial Kit	\$7.00
(45-1590-1)	Kit Less Transmission Line	\$4.50
45-1585	Broad-Band Reflector Kit	\$5.50
45-1591	High-Frequency Reflector Kit	\$3.00

**PHILCO TEMPORARY INDOOR
TELEVISION ANTENNA**

For use in high-signal-strength areas, where it is not possible to install the conventional type of outside antenna because of fire underwriter restrictions or building codes, or for temporary use when the installation of an outside antenna cannot be made because of inclement weather or icy roofs.

Designed to resemble an oriental screen, the Philco Temporary Indoor Television Antenna may be folded to form an "L" or a semi-accordion shape, and may be placed back of furniture or on the floor under rugs. Complete instructions for installation and operation are provided.

PART NO.	LIST PRICE
45-1623	\$5.95

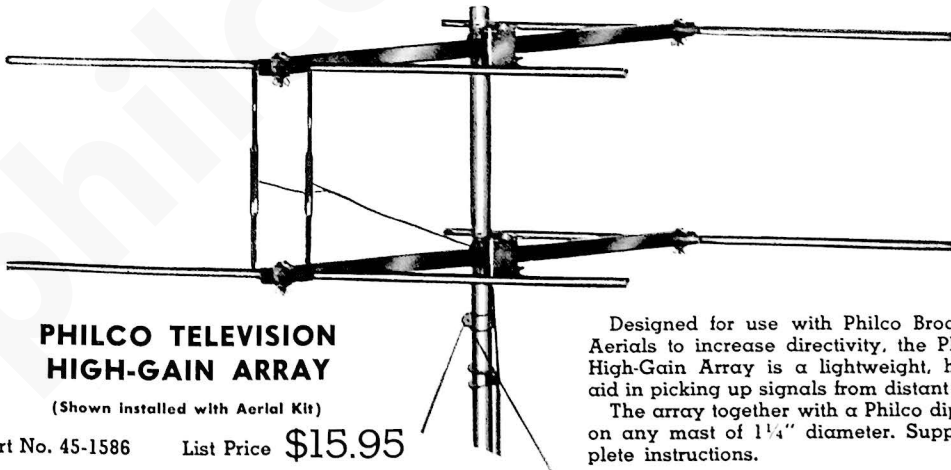

**PHILCO TELEVISION
HIGH-GAIN ARRAY**

(Shown installed with Aerial Kit)

Part No. 45-1586 List Price **\$15.95**

Designed for use with Philco Broad-Band Dipole Aerials to increase directivity, the Philco television High-Gain Array is a lightweight, highly effective aid in picking up signals from distant TV stations.

The array together with a Philco dipole will mount on any mast of 1 1/4" diameter. Supplied with complete instructions.

PHILCO HIGH-FREQUENCY TRANSMISSION LINES

Maximum energy transfer from aerial to receiver is obtained with the use of Philco's FM and TV transmission lines and coaxial cables.

Manufactured under the famous Philco system of quality control, both the FM and TV transmission lines have special brown polyethylene insulation, constant spacing, and uniform impedance.

Unaffected by weather and wind strain, the highly refined, 7-strand, No. 28 copper wire pair, results in an attenuation of only 2.7 db per 100 feet.

The FM line has a characteristic impedance of 150 ohms at 100 mc., and is .185 inch wide, with conductors spaced .12 inch center to center.

The TV line has a characteristic impedance of 300 ohms at 100 mc., and is .437 inch wide, with conductors spaced .3 inch center to center.

Both the FM and TV transmission lines are supplied on 250 and 500-foot spools.

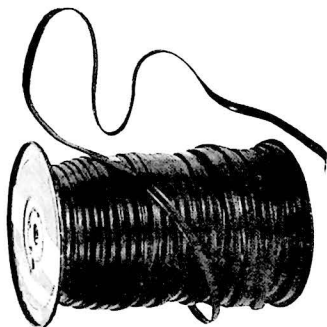

STANDOFF INSULATOR

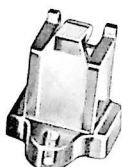

For all FM and TV transmission lines. Made of high-quality, transparent plastic. 1 inch high. Grips all FM and TV ribbon type transmission lines firmly. Has base hole for screw mounting.

PART NO. LIST PRICE
54-4602 \$0.10

PART NO.	DESCRIPTION	LIST PRICE
45-1495	150-ohm FM line (250 ft.)	\$10.00
45-1495-1	150-ohm FM line (500 ft.)	20.00
45-1541	300-ohm TV line (250 ft.)	11.25
45-1541-1	300-ohm TV line (500 ft.)	22.50
5L1245	Coaxial Cable RG11U (per ft.)	.25
45-9524	Coaxial Cable 59TV (500 ft.)	60.00

PHILCO AERIAL COUPLERS

For peak performance of loop-aerial, all-wave Philco radios, Philco aerial couplers include an image-trap coil, a short-wave choke, an i-f trap, an adjustable, slug-tuned short-wave coil, and an FM transformer, all mounted in a small, aluminum can. A switch is provided to peak for local or long-distance reception. Equipped with 4-prong plug connector.

PART NO.	LIST PRICE
45-1598 (for 1949 radios)	\$5.95
76-1134 (for 1941 radios)	5.95
76-2353 (for 1946, '47, '48 radios)	5.95



PHILCO LIGHTNING ARRESTOR

A precision-made safety device, the Philco lightning arrestor is insurance against damage to delicate radio parts during storms and similar weather, when large static charges may be attracted by an aerial system and grounded through the radio.

Provided with a simple 2-terminal connector—to aerial and ground—for quick, easy installation. Internal gap for safety discharge.

PART NO.	LIST PRICE
45-6315	\$0.65



AERIAL MOUNTING BRACKETS

These versatile mounting brackets are invaluable as a time-and-work saver in the erection of aerials on sloped and peaked roofs. Holes are provided for securing the bracket to the roof. Made of heavy-duty galvanized iron, they will provide adequate protection against high winds and storms, and will accommodate any Philco FM or Television Aerial.

PART NO.	DESCRIPTION	LIST PRICE
28-3757-1	Sloping Roof Mounting Bracket	\$1.80
28-3758-1	Peaked Roof Mounting Bracket	2.25

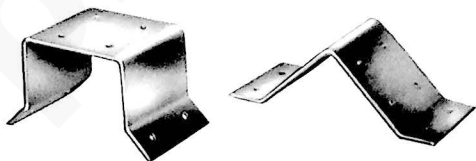



PART NO.
45-1469

LIST PRICE
\$2.25

**PHILCO
FARM
AERIAL**

Philco farm aerials are purely post-war kits, with tremendous appeal for use on farms and in other unwired rural areas. Made of high-quality, long-lasting materials, and assembled

in complete ready-to-install kit. Includes 60 feet of solid aerial wire and 40 feet of lead-in wire, assembled with corrosive-proof joints, lightning arrester, insulators, window lead-in strip, and ground clamp. Packaged in attractive display box with hook-up diagram.



PART NO.
45-1494

LIST PRICE
\$2.25

**PHILCO
OUTDOOR
AERIAL**

Philco outdoor aerials include the same solid-wire aerial as specified by the Army Air Forces, to insure a sturdy, effective system for improving the reception of any radio.

The kit comes complete, ready to install, and includes 60 feet of solid aerial wire and 40 feet of lead-in wire, assembled with corrosive-proof joints, lightning arrester, insulators, window lead-in strip, ground clamp, and hook-up wire. Packaged in attractive counter display box.

PHILCO FM AERIAL KITS

Designed to provide maximum signal pickup for FM receivers, the Philco line includes a dipole FM aerial kit especially engineered for the 88-108-mc. FM band.

The Philco FM dipole aerial may be wall or window-sill

mounted on the galvanized-iron pipe bracket supplied in the kit. The dipole can be mounted on the Philco mast kit (supplied separately), and can also be used with the Philco reflector kit. Complete instructions are included with each kit.

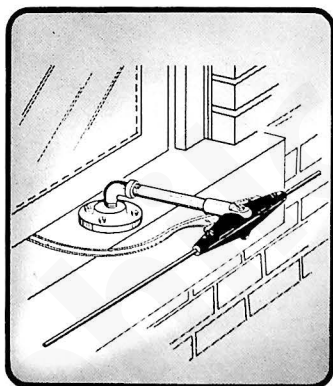

45-1462—Dipole FM Aerial Kit
(Basic kit shown window-sill mounted)

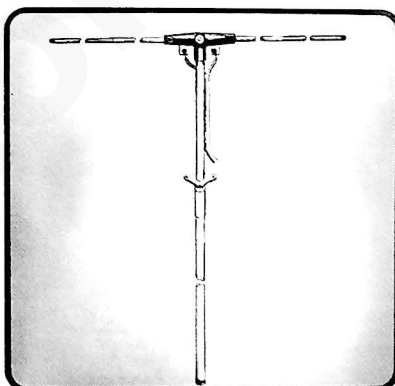

45-1465—FM Mast Kit
(Shown with basic aerial kit mounted)

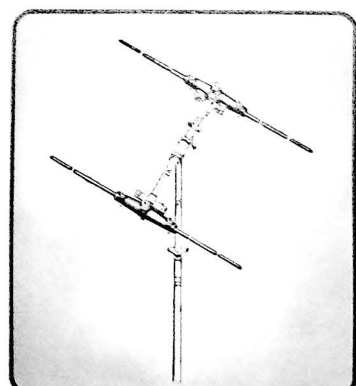

45-1464—FM Reflector Kit
(Includes cross support shown with basic kit on mast)

PART NO.	DESCRIPTION	LIST PRICE
45-1462	Dipole FM Aerial Kit (basic kit shown window-sill mounted)	\$7.95
45-1465	FM Mast Kit (shown with basic aerial kit mounted)	4.00
45-1464	FM Reflector Kit (includes cross support shown with basic kit on mast)	5.50



PHILCO STREAMLINED SIDE-COWL AERIAL

Weather-proofed in three-section style, the Philco Streamlined Side-Cowl Aerial extends to a full 66 inches.

The use of chrome-plated Admiralty brass tubing insures excellent electrical and physical stability and anti-rattle construction.

Low-loss leadin, for finest reception. "Easy-on" connector for quick, positive attachment.

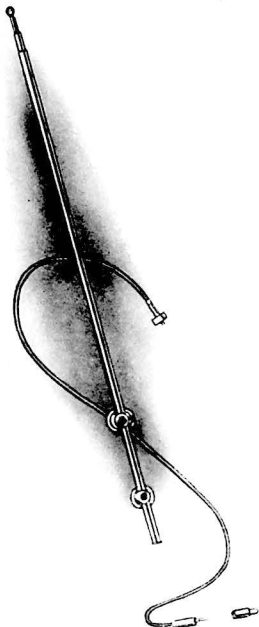

PART NUMBER

45-2989-1

LIST PRICE

\$4.95

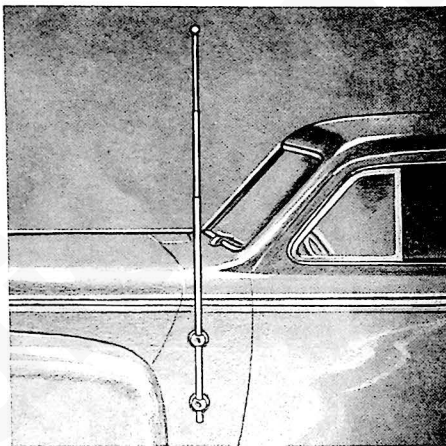

PHILCO DISAPPEARING TOP-COWL OR FENDER AERIAL

A deluxe aerial for ultra-smart appearance on any car, the Philco Disappearing Top-Cowl or Fender Aerial has a special easy-installation feature allowing quick and convenient mounting.

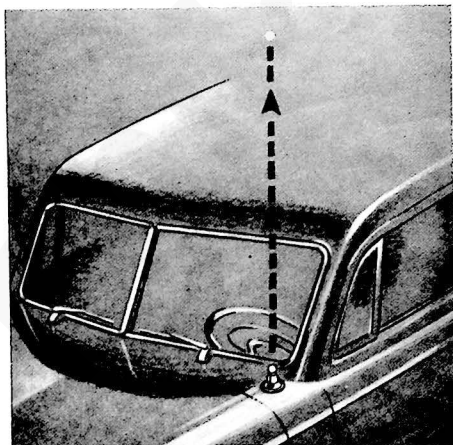

Constructed of Admiralty brass tubing, heavily chromed for weather protection and electrical conductivity. Extends to 54 inches.

Dust and moisture-proof, with low-loss leadin.

PART NUMBER

45-3020

LIST PRICE

\$6.95

WITH 18" LONGER LEADIN

Same as above except for 18-inch longer leadin for automobiles needing this extra length. Necessary for many of the newer automobiles.

PART NO.
45-3020-1

LIST PRICE
\$7.25

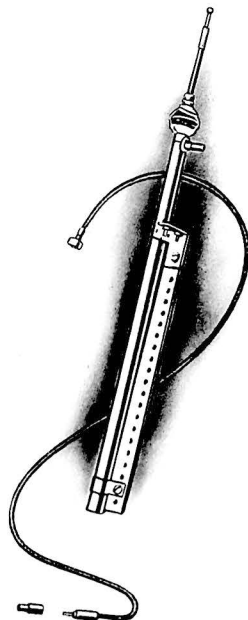

PHILCO TOP-COWL OR FENDER AERIAL

Especially designed for the newest cars, Philco top-cowl or fender aerials actually add to the appearance of any automobile.

Installed and adjusted from the top, Philco top-cowl or fender aerials cannot come loose.

Chrome-plated for weather durability. Extends to 56 inches. "Microloss" leadin with polyethylene insulation.

PART NUMBER
45-3019

LIST PRICE \$5.35

WITH 18" LONGER LEADIN

Same as above except for 18-inch longer leadin for automobiles needing this extra length. Necessary for many of the newer automobiles.

PART NO. 45-3019-1 **LIST PRICE** \$5.60

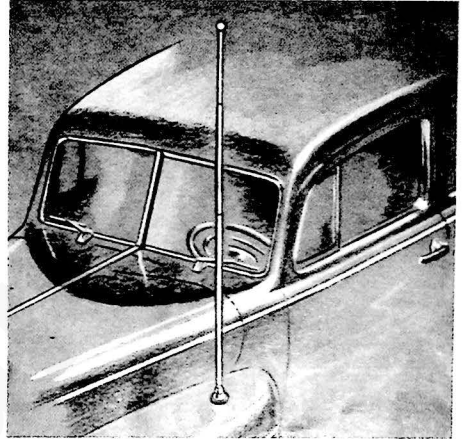

PHILCO SPECIAL SIDE-COWL AERIAL

A quality aerial, especially designed for fine performance at low cost.

Constructed of chrome-plated Admiralty brass tubing, for beauty and weather durability, the Philco special side-cowl aerial features sturdy, anti-rattle construction. Extends to 43½ inches.

Includes high "Q", low-loss, fully shielded leadin with polyethylene-vinylite insulation.

PART NUMBER
45-3021

LIST PRICE
\$2.49

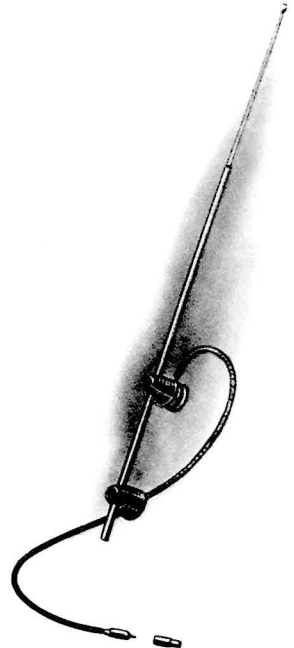
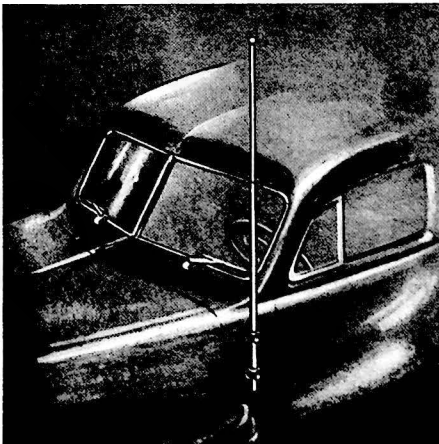



PHILCO LONG-DISTANCE SIDE-COWL AERIAL

A powerful signal-puller for the growing number of owners who want maximum signal strength and station coverage.

The special 100-inch extension has extra-heavy chrome-plated Admiralty brass tubing, for positive anti-rattle construction.

Dust-proof and moisture-proof, the long-distance side-cowl aerial offers the utmost in efficiency. "Microloss" leadin, with polyethylene-vinylite insulation.

PART NUMBER

45-2985

LIST PRICE

\$6.95

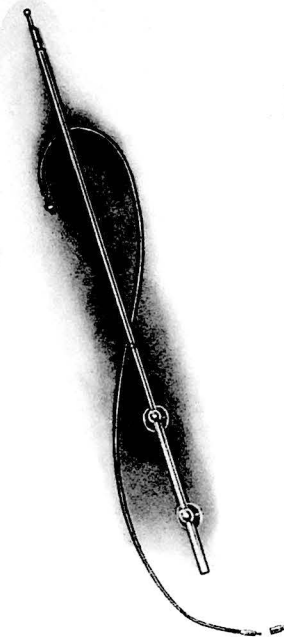
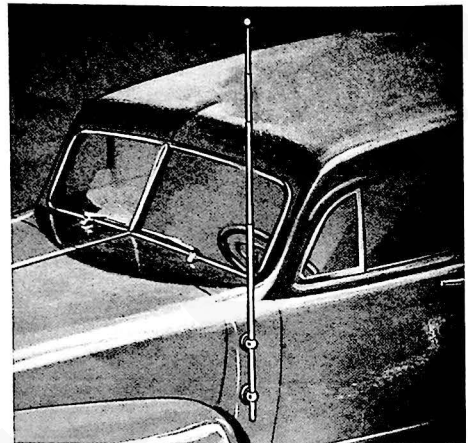

AUTO AERIAL LEAD-IN EXTENSION

Skillfully assembled of the finest-quality shielding and dielectric materials, the Philco Auto Aerial Lead-in Extension is a valuable time saver, reducing the work necessary for fender and other installations requiring additional aerial leadin. Cable is 18 inches long, including Philco Part No. 57-0590 antenna connector plug.

PART NO.

95-0123-1

LIST PRICE

\$1.50

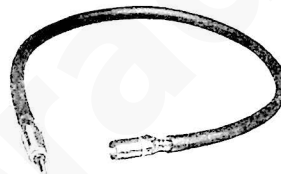

PHILCO DUOFLEX AUTO AERIAL

A smartly-designed, highly effective aerial, the Philco Duoflex has a special feature—a two-way tilt to blend with the streamlining of the car. Length, 66 inches, extended.

Anti-rattle construction is assured by the use of heavy, chrome-plated Admiralty brass tubing. Firm physical and electrical contacts result in low-noise listening pleasure.

Low-loss leadin.

PART NUMBER

45-2987

LIST PRICE

\$5.95

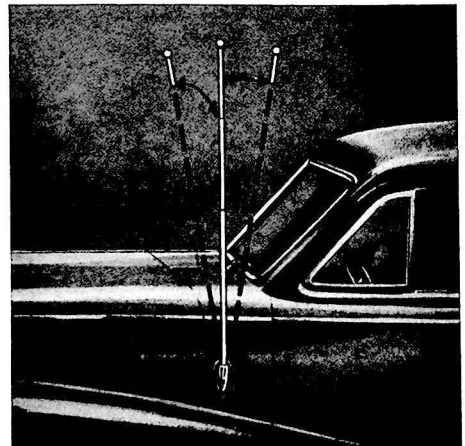

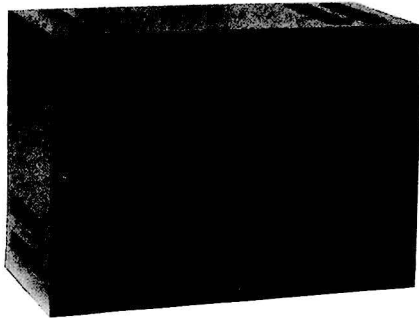

**PHILCO
CROSSHATCH
GENERATOR
MODEL 5072**



**DEALER NET
\$39.95**

The Philco Model 5072 Crosshatch Generator is a unique instrument for aligning the vertical and horizontal sweep circuits of television receivers; it eliminates the need for test charts from a television station.

Inexpensive, practical, and ultra-adaptable, this generator comes complete in a compact, steel case with Philco Adapter Harness No. 1 for connection to Philco Television Receiver Models 48-1000 and 48-2500.

The required plate power, heater power, and synchronizing voltages for the generator are obtained, through the adapter harness, from the television receiver being adjusted.

Harness No. 1 comprises four color-coded socket adapters, a cable, and a female plug for connection to the generator.

Adjustment of the generator is rarely necessary, but if desired, controls are easily accessible inside the case.

Complete instructions supplied with each unit.

FEATURES

- Dimensions: 4 $\frac{1}{2}$ " x 6 $\frac{1}{2}$ " x 3 $\frac{5}{8}$ "
- Four newly-developed tubes (12AU7)
- For any television set with proper adapter harness
- Compact size
- Number of horizontal and vertical lines easily changed by two controls which are protected inside case
- Stable circuit and component design
- Color-coded adapter-harness connectors
- Operates on voltages from set under alignment
- Practically no adjustment of generator necessary
- Sturdy louvered steel cabinet
- Light weight for portability
- Made under famous Philco system of quality control

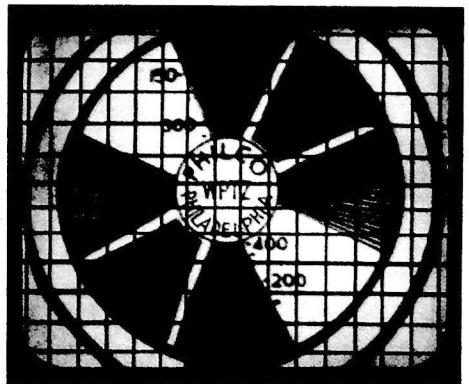

PHILCO ELECTRONIC CIRCUIT MASTER

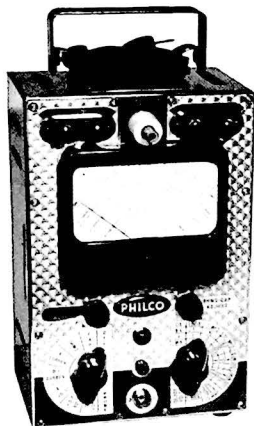

MODEL 7001

The Philco Model 7001 Electronic Circuit Master is especially designed for making ALL of the measurements required in the everyday work of the serviceman.

Basically a highly-efficient vacuum-tube voltmeter, the measurement of radio and high audio-frequency voltages up to 200 mc. is possible with the use of the High-Frequency Probe.

The Electronic Circuit Master can measure very small r-f voltages (using the High-Frequency Probe) without draining energy from the circuit under test; this feature permits the measurement of voltages in circuits actually in operation.

Ordinary voltage and current measurements in radios; high-voltage measurements of 10,000 to 30,000 volts in television sets (using High-Voltage Probe); capacitance—these are only a few of the uses for this new Philco development.

Complete instructions are supplied with each unit.

DEALER NET
\$104.50

SPECIFICATIONS

Dimensions: 6½" x 12½" x 8"

Operating voltage: 110-120 volts, 60 cycles

Tubes: (1) 6SN7, (2) 7B5, (1) 7Y4

Voltage ranges: (D.C.) 0 to 10,000 volts in 8 steps
(A.C.) 0 to 100 volts (50-5000 cycles); 0 to 10,000 volts
(60 cycles)

(First ranges: 1 volt Full Scale)

Accuracy: ±3% of full scale

Current ranges: (D.C.) 0 to 100 ma. in 3 steps

(First range: 0-1 mil)

0 to 30 amps. in 2 steps

Accuracy: ±5% of full scale

(A.C.) 0 to 10 amps.

Accuracy: ±3% of length of scale

Decibels: -21.5 to +54.5 in 7 steps

Accuracy: ±3% of full scale

HIGH-VOLTAGE PROBE

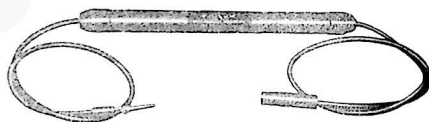

Used to extend the a-c and d-c voltage range of the Electronic Circuit Master for measurements from 10,000 to 30,000 volts.

PART NO. DEALER NET
45-1550 \$23.80

HIGH-FREQUENCY PROBE

Used to extend the frequency range of the Electronic Circuit Master for a-c voltage measurements from 5000 cycles to 200 mc.

PART NO. DEALER NET
45-1547 \$15.45

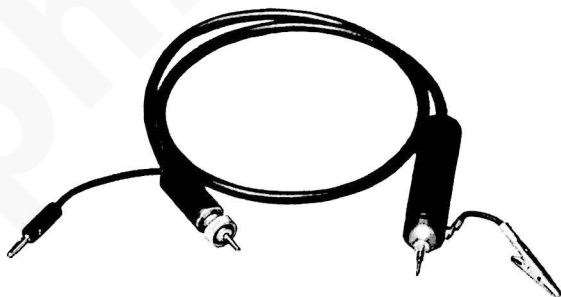

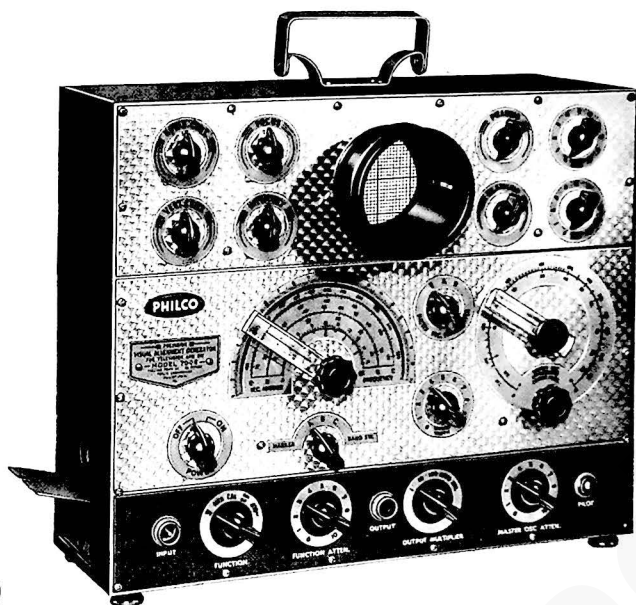

PHILCO VISUAL ALIGNMENT GENERATOR MODEL 7008

The only instrument of its kind, combining all functions for a complete, accurate visual alignment and test of Television and FM Receivers. Includes five different signal generators and their associated controls; a complete oscilloscope with centering, gain, focus, intensity, phasing, and blanking controls; and power supplies. A separate r-f probe permits signal tracing of sensitive circuits without disturbance. Removable crosshatch screen for special ultra-short 3-inch cathode-ray tube. Compartment for storage of all cables, including r-f probe. (Cables not illustrated.) The new Philco 7008 Visual Alignment Generator combines in one economical instrument functions that can be approached only in a cumbersome, costly collection of conventional devices.

Eliminates the Two Standard Generators and Oscilloscope Previously Necessary

FEATURES

- AM Generator (and Marker): 3.2-250 mc.
- FM Generator: 4-120 mc., and 145-260 mc.
- Sweep-frequency width to 15 mc. (Flat to within .2db/mc.)
- Audio generator: 400 cycles
- Only one input and one output connection
- Special oscilloscope circuits
- Vertical-deflection sensitivity: 25 millivolts inch (with amplifier)
- Swiveled cathode-ray-tube housing for compact carrying size
- Telescoping light shield
- High-frequency probe for signal tracing
- Crystal calibrator to provide check points for generators

SPECIFICATIONS

- Dimensions: 16" x 16" x 6½"
- Operating voltage: 110-120 volts, 60 cycles
- Tubes (1) 6X4, (1) 6J6, (2) 6AK5, (1) 7F7, (1) 3MP1, (1) 5Z4

DEALER NET

\$395.00

PHILCO
JUNIOR SCOPE
MODEL 7019



DEALER NET
\$66.00

The Philco Model 7019 Junior Scope fills the need for a practical piece of test equipment having small size and light weight. The 7019 is a complete cathode-ray oscilloscope with a newly designed cathode-ray tube, vertical and horizontal amplifiers, self-contained sweep circuit, self-contained synchronization, and complete power supply.

This instrument is useful for the measurement of frequencies up to one-hundred kilocycles, both vertically and horizontally. With slight loss in gain, measurements can be made as high as two-hundred kilocycles on both axes. Its applications are practically unlimited; it is especially useful in the study of wave shapes, in measurements of modulation percentage, peak voltages, phase shift, hum, and distortion, and in the adjustment of audio amplifiers and all radio receiving and transmitting equipment, except very-high-frequency equipment.

A telescoping light shield (which also serves as a magnetic shield) for the cathode ray tube permits the use of the equipment in brightly lighted rooms. This shield provides a wide angle of vision.

SPECIFICATIONS

Operating voltage: 105-125 volts, 50-60 cycles

Tubes: 6AU6, 6J6, 6X4, 2AP1-A (2" screen)

Dimensions: 6³/₈" x 4" x 10"

Terminals: for vertical and horizontal-sync input voltages

Vertical-deflection sensitivity: 1 v/inch, R.M.S. (with amplifier)

30 v/inch, R.M.S. (direct connection)

Input resistance: .5 megohm

Input series capacitance: .1 mfd., 600 volts

Sweep-frequency range: 10 cycles to 60 kc.

Light shield: adjustable to 1¹/₂" extension

Sweep circuit: multivibrator

PHILCO DYNAMIC TESTER

MODEL 7030



DEALER NET
\$52.50

The Philco Model 7030 Dynamic Tester is a modern test instrument designed for FAST diagnosis of radio trouble. Basically, this instrument consists of a detector and high-gain audio amplifier with loud-speaker output, for locating troubles by listening in on radio-frequency and audio-frequency circuits. In any circuit which normally has a signal present, the Dynamic Tester not only detects the signal, but also gives a comparative indication of its intensity.

The sensitivity of the Dynamic Tester (gain 10,000) is such that the signals which tell the story can be picked off the circuits of a radio, all the way from the aerial coil to the speaker voice coil.

The probe input circuit is adjustable to high impedance, making it possible to apply this all-in-one, searchlight-head instrument to any circuit without interfering with its operation.

Because of its basic method of testing, the Dynamic Tester is a real aid in immediately locating the sources of intermittent radio troubles, noisy parts, distortion, and hum in any circuit.

Supplied with complete instructions.

SPECIFICATIONS

- Sensitivity: gain 10,000
- Frequency coverage: 60 cycles to 100 mc.
- Probe: adjustable for 4 input capacities
- Lucite head
- 6-8-volt searchlight lamp built in
- Output jack: for voltmeter connection
- Input jack: for microphone or phono pickup
- Output: 2 watts undistorted maximum
- Operating voltage: 110-120 volts, 60 cycles
- Tubes: 6AQ6, 7L7, 7A5, 7Y4
- Dimensions: 10" x 6½" x 4½"



Dealer Net
\$49.20

PHILCO TUBE TESTER

MODEL 7050 A

Once you see and try this new Philco instrument you will never be content until you have one in your shop. With its new styling and improvements, the 7050A is by far the best tube-tester value the market has ever offered. In addition, no other tube tester, pre-war or post-war, enables you to complete a test so quickly, conveniently, and accurately. Customers who see it are instantly impressed, and gain added confidence in your service methods. An important new feature of the 7050A is a new, loose-leaf chart, easy to revise and keep up-to-date. You no longer need to worry with roll charts and bound manuals every time a new tube is announced. The 7050A saves time and work, and is far ahead of the field. A specially designed "short" test circuit supplies the extra sensitivity necessary to find an internal tube short which, in many cases, cannot be found with other tube testers.

A few of its many features are listed below.

9-PIN MINIATURE SOCKET



For installation on Model 7050 tube tester to test new jumbo miniature tubes. Complete instructions included.

PART NO.
45-1578

DEALER NET
\$0.80

FEATURES

All standard sockets and new 9-pin miniatures, (included as kit with complete instructions), plus 1 blank for future developments.

Positive short indication.

Chrome-plated brass panel with hammerlin trim.

Dimensions: 13" x 10 $\frac{7}{8}$ " x 4 $\frac{5}{8}$ ".

Registration card is bound on top of test chart. This card enables each purchaser to register his name at Philco Headquarters for receipt of additional information covering tube types that may be developed in the future.

New loose-leaf, quick-reference test chart covers all tube types, and is permanently attached to tester by means of hinged metal cover.

Precision parts are used throughout.

Oversized continuous-duty transformer does not heat up.

Vinylite-covered wire is moisture-proof and fungus-proof. Ideal for areas subject to humidity and dampness.

Contains the advanced-engineered Philco Element Switching System.

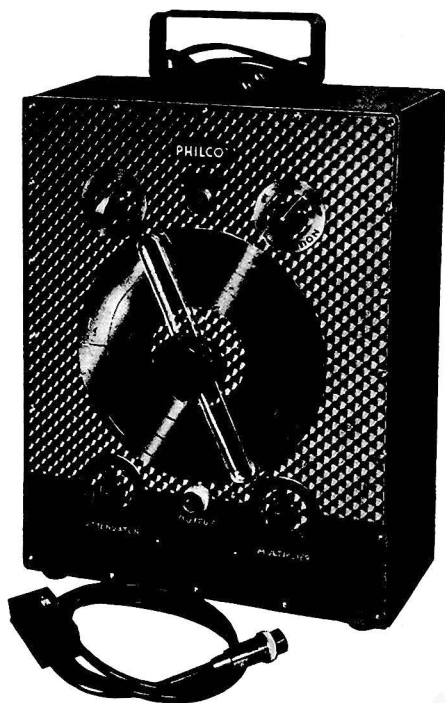

PHILCO R-F SIGNAL GENERATORS

MODEL 7070 (AM)
AND MODEL 7170 (FM & AM)

The Philco R-F Signal Generators are designed for precision-alignment work, and for all tests employed by the radio-service technician and the laboratory engineer in AM, FM, and TV work.

Unusual freedom from r-f leakage and radiation, and special design and shielding of attenuator components give the instrument excellent control of output, permitting meticulous adjustments on highly-sensitive receivers.

The radar-proved cathode-follower r-f-output coupling system, for frequency stability, is one of the many features of these post-war instruments.

Model 7070 supplies a six-band r-f output for complete coverage of frequencies from 100 kc. to 110 mc.—all fundamental frequencies.

Model 7170 supplies frequencies from 100 kc. to 170 mc., and up to a 1 mc. sweep frequency.

MODEL	DEALER NET
7070	\$97.50
7170	\$132.00

SPECIFICATIONS (MODEL 7070)

Operating voltage: 110-120 volts, 60 cycles

Tubes: 6C4, 7F8, 6X5GT

Frequency coverage:

R-F: 100 kc. to 110 mc. (six bands)

Audio: 400 cycles

R-F output: .6-1 volt, r.m.s., (depending upon range)

A-F output: 1 volt, r.m.s., (approx.)

Accuracy: $\pm 1\%$ of scale reading

Stability: $\frac{1}{2}$ of 1% frequency drift (after warm-up)

Dimensions: 10" x 13" x 4 $\frac{1}{2}$ "

Output cable: 36" of low-loss coaxial cable

PHILCO UNIVERSAL I-F TRANSFORMER



PART NO.	LIST PRICE
45-6365	\$4.95

A brand new Philco development which enables dealers and servicemen to stock only one i-f transformer to duplicate any i-f transformer in use—either old type or new.

This new unit, the Philco Universal I-F Transformer, is designed to function at top efficiency by the use of multi-tapped windings, convenient adjustments, and built-in components for additional circuits.

These features, plus compact size and adjustable mounting studs, allow simple installation and exact duplication of the gain and selectivity of the original circuit.

Complete instructions included.

ADAPTABLE TO ALL THESE CIRCUITS. COMPONENTS ARE BUILT-IN.

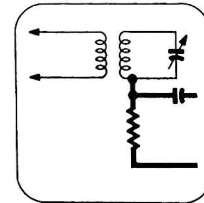
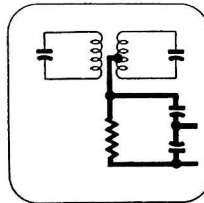
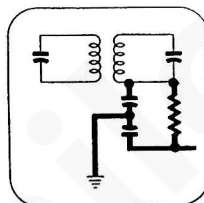
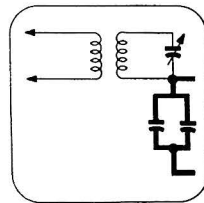
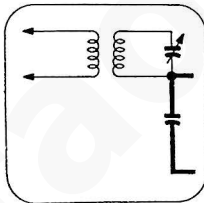
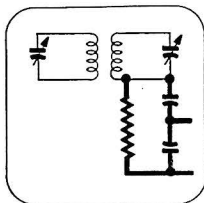

CHARACTERISTICS

Frequency Ranges—All i-f bands: 175 kc., 260 kc., 455 kc.

Adjustments—Double-tuned, variable inductance, variable coupling, for complete control of gain, band width, and selectivity.

Connections—All circuits shown in adjoining schematics are possible by use of simple jumpers on base terminal-board pins.

Additional Circuits—Built-in diode networks can be used, if desired.

Construction—Impregnated against moisture. Primary screw is nickel-plated; secondary screw is copper.

Size—Only 1 1/4" x 1 1/4" x 2 3/4".

PHILCO BROADCAST- BAND UNIVERSAL R-F AND ANTENNA COILS

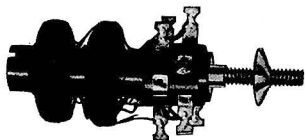

Universal R-F or Antenna Coil—Unshielded



Universal R-F or
Antenna Coil—
Shielded

Designed to replace r-f or antenna coils in any radio set. Its features include high-gain, iron-core tuning adjustment, coupling and inductance adjustments, and two multi-tapped windings for exact duplication of original characteristics. Can match any high or low impedance transmission line or loop aerial.

The compact, shielded type has adjustable-stud mounting and base terminal block. The unshielded type has convenient, single-stud mounting.

Impregnated against moisture. Frequency range: 530 to 1700 kc. Complete instructions included.

PART NUMBER	TYPE	LIST PRICE
45-6378...	Shielded (1 1/4" x 1 1/4" x 2 5/8")\$4.00
45-6364...	Unshielded (1 3/4" x 1 1/8") 2.75

PHILCO BROADCAST-BAND UNIVERSAL OSCILLATOR COIL



The ideal replacement part for the broadcast-band oscillator coil in any radio, this coil has a wide frequency range of 705 to 2190 kc., covering the broadcast band for any i.f. from 150 to 500 kc. Other features include adjustable inductance for exact matching and tracking, multi-tapped design for correct circuit matching, and impregnation against moisture.

Convenient, single-stud mounting. Size: 1 3/8" x 3/8". Complete instructions included.

PART NO.	LIST PRICE
45-7502	\$1.25

PHILCO UNIVERSAL POLICE-BAND COIL

Here is the answer to the serviceman's replacement problems in police-band antenna, r-f, and oscillator circuits.

The basic form has a high-grade, tuned-iron-core coil, which has a frequency range of 1.7 to 6 mc. It is multi-tapped for proper matching and tracking in oscillator or r-f circuits.

Slip-on primaries, supplied in both high and low-impedance types, complete the adaptability of this truly universal police-band coil. Can match any high or low impedance transmission line or loop aerial.

Convenient, single-stud mounting. Impregnated against moisture. Complete instructions included.

PART NUMBER	TYPE	LIST PRICE
45-6389-2.....	Basic coil (1 3/8" x 1")\$1.75
45-6389-1.....	Low-impedance primary 1.75
45-6389-3.....	High-impedance primary 2.00

PHILCO UNIVERSAL SHORT-WAVE COIL

The finest materials and engineering make the Philco universal short-wave coil the answer to the serviceman's replacement problems.

The features of this coil include iron-core slug-tuned coil, and impregnation against moisture.

Multi-tapped for proper frequency and circuit matching, the Philco universal short-wave coil will replace any short-wave coil in antenna, r-f, and oscillator circuits with a frequency range of 6 to 18 mc. Can match any high or low impedance transmission line or loop aerial.

Single-stud mounting. Size: 1 3/8" x 3/8". Complete instructions included.

PART NO. 45-6389	LIST PRICE \$2.50
------------------	-------------------

UNIVERSAL VOLUME CONTROLS

Many outstanding features make the Philco universal volume control far and away the leader in its field.

ONLY PHILCO HAS IT! A competitively priced control which includes screw-lock switch and silver-plated contacts. If switch action is desired, simply remove screw.

ONLY PHILCO HAS IT! The famous welded rotor contact eliminates the chief source of volume-control noise.



LIST
PRICE
\$1.25
EACH

SHAFT TYPE
SHAFT LENGTH: 3"
FLAT: 1/4" DIAMETER
BODY DIAMETER: 1 1/8"

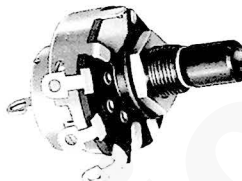

SHAFT-SAVER TYPE
SHAFT SLEEVE: 1/4" INSIDE DIAMETER
BODY DIAMETER: 1 1/8"

Philco solves 90% of your potentiometer replacement problems with a universal line of 21 controls.

Listed below are these controls, with additional information on their tapers and possible uses. Sup-

plied with 3" shaft or shaft-saver sleeve for using any length shaft. Stock this Philco line designed to meet practically every need in your service replacement work.

POSSIBLE TAPER APPLICATIONS

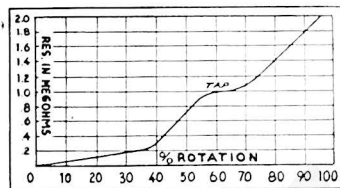

"A" TAPER

Tone compensation and similar audio-control circuits.

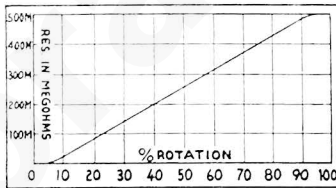

"B" TAPER

Bias control and most television set controls requiring linear taper.

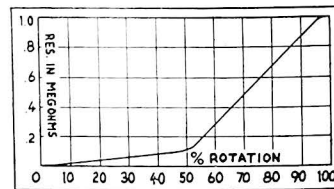

"C" TAPER

Volume controls, tone controls, and bias controls.

RESISTANCE IN OHMS	TAPER	RESISTANCE IN OHMS AT TAP	SHAFT-TYPE PART NO.	SHAFT-SAVER TYPE PART NO.	RESISTANCE IN OHMS	TAPER	RESISTANCE IN OHMS AT TAP	SHAFT-TYPE PART NO.	SHAFT-SAVER TYPE PART NO.
5,000	B		45-5001	45-5021	350,000	B		45-5020*	45-5040*
10,000	B		45-5010	45-5030	350,000	B		45-5013	45-5033
10,000	C		45-5002	45-5022	500,000	A	250,000	45-5007	45-5027
15,000	B		45-5014	45-5034	500,000	B		45-5019	45-5039
25,000	B		45-5003	45-5023	500,000	B		45-5018*	45-5038*
50,000	C		45-5004	45-5024	1,000,000	A	500,000	45-5008	45-5028
100,000	B		45-5015	45-5035	1,000,000	A	500,000	45-5017*	45-5037*
100,000	C		45-5005	45-5025	1,000,000	B		45-5012	45-5032
250,000	A	125,000	45-5006	45-5026	1,000,000	B		45-5041*	45-5042*
250,000	B		45-5016	45-5036	2,000,000	A	1,000,000	45-5009	45-5029
350,000	A	70,000	45-5011	45-5031					

* All controls shown have SPST switches, except those indicated with asterisk, which have DPST switches.

PHILCO VIBRATORS

The famous Philco line of vibrators has two outstanding features:

- 4 types replace more than 1000 types in use
- Driver contact system for instant starting

Only the 4 Philco vibrators shown below will enable you to replace over 1000 types of vibrators, made by many different manufacturers.

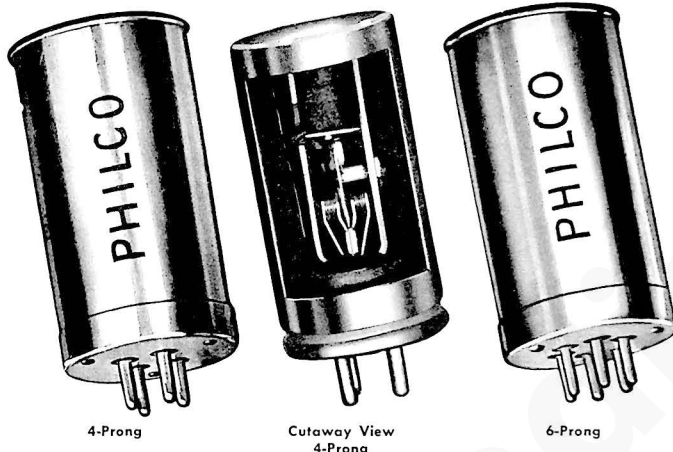

The driver contact system, used only in Philco vibrators, has a separate driver contact to the battery, to assure instant starting regardless of battery voltage. Any auto radio can be given this advantage by replacing with a Philco vibrator. Welded contact leads defy loosening from vibration.

Sponge rubber blocks are provided with each vibrator for cushioning in oversized spaces. Size: 1½" by 2¾".

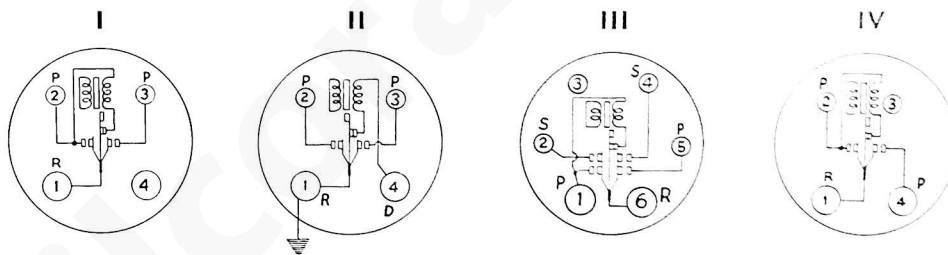

DIAGRAMMATIC BOTTOM VIEW OF PHILCO VIBRATORS

- I—Universal 4-pin interrupter, dia., 1½"; length, 2¾"; replaces most vibrators.
- II—Philco standard 4-pin interrupter, dia., 1½"; length, 2¾"; replaces most Philco vibrators.
- III—Universal 6-pin synchronous, dia., 1½"; length, 2¾"; replaces most synchronous vibrators.
- IV—Special-base 4-pin interrupter, dia., 1½"; length, 2¾"; replaces most special-base vibrators.

I
 PART NO. 45-6307
 LIST PRICE

\$3.50

II
 PART NO. 83-0026
 LIST PRICE

\$3.50

III
 PART NO. 38-9910
 LIST PRICE

\$5.75

IV
 PART NO. 38-9912
 LIST PRICE

\$3.75

**CROSS-INDEX OF PHILCO VIBRATORS
REPLACEMENTS FOR VIBRATORS OF OTHER MANUFACTURE**

PHILCO PART No. 38-9910 replaces:

MANUFACTURER	MODEL	MANUFACTURER	MODEL	MANUFACTURER	MODEL	MANUFACTURER	MODEL
ELECTRONIC	EU5	UTAH	NP62	RADIART	4318	MALLORY	MU6
	441		SP60		5400		246
	720		SP66		5411		246A
	730		SP606		5420P		246P
	2089		SP660		5421		W248
			SV68		5435		248
			ZC		5439		264
			18923		5610		277S
			18891				P285Y
							523
							526
							504
							743
							951P

PHILCO PART No. 38-9912 replaces:

MANUFACTURER	MODEL	MANUFACTURER	MODEL	MANUFACTURER	MODEL	MANUFACTURER	MODEL
ELECTRONIC	EU3	UTAH	NP45	RADIART	5303	MALLORY	602
	435		NP480		5333		625
	2088		NP487		5334		626
					5335		629C
					5339		634C
							642C
							651
							652
							660
							663
							670
							665
							851
							852
							860
							863
							868
							870



CROSS-INDEX OF PHILCO VIBRATORS
REPLACEMENTS FOR VIBRATORS OF OTHER MANUFACTURE (C o n t .)

PHILCO PART No. 45-6307 replaces:

MANUFACTURER	MODEL	MANUFACTURER	MODEL	MANUFACTURER	MODEL	MANUFACTURER	MODEL
ELECTRONIC	EU1	UTAH	NP4	RADIART	5300	MALLORY	4-4
	EU2		NP42		5301		250
	405		NP41		5307		251
	420		NP46		5308		253
	440		NP44		5320P		282P
	443		NP47		5321		282B
	446		NP48		5323P		294
	450		NP49		5326P		500P
	P450				5331		505P
	451				5342M		506P
	452				5500		507P
	453						508P
	454						512P
	455						509P
	456						510P
	457						600
	458						650
	467						656
	468						657
	475						658
							659
							662
							666
							669
							839
							850
							859
							869
							866
							901M
							902M
							903M

MODEL LISTINGS FOR VIBRATOR REPLACEMENT

STOCK ONLY 4 PHILCO VIBRATOR TYPES
TO COVER MORE THAN 1000 AUTO RADIO MODELS

MANUFACTURER	MODEL	PHILCO VIBRATOR PART No.	MANUFACTURER	MODEL	PHILCO VIBRATOR PART No.	
Admiral	5F	45-6307	Arvin (cont.)	38	45-6307	
	6A	45-6307		39	45-6307	
	6D	45-6307		42	45-6307	
	6E	38-9910		44C(RE46)	45-6307	
	7A	45-6307		280M	45-6307	
	55	45-6307		510(RE54)	45-6307	
	66	45-6307		520	45-6307	
	69	45-6307		610(RE58)	45-6307	
	77	45-6307		620	45-6307	
	78	45-6307		710(RE59)	45-6307	
	88	45-6307		720	45-6307	
	512-6D	45-6307		810(RE60)	45-6307	
	660	45-6307		820	45-6307	
	770	45-6307		821	45-6307	
	780	45-6307		Atwater Kent	126	45-6307
	880	45-6307			136	45-6307
	950-6A	45-6307			237Q	45-6307
	965-6A	45-6307			2372	45-6307
	P4-16	45-6307			416	45-6307
	4-6	45-6307			446	45-6307
	Airline	60		45-6307	467Q	45-6307
62		45-6307	566	45-6307		
119		45-6307	Autocar	23	45-6307	
62-192		45-6307		24	45-6307	
62-202		45-6307		92	45-6307	
62-236		45-6307		359	45-6307	
62-242		45-6307		505	45-6307	
62-263		45-6307		518	45-6307	
62-264		38-9910		518S	45-6307	
62-280A		38-9910		530	45-6307	
62-292		38-9910	618	45-6307		
62-294		38-9910	618S	45-6307		
62-345		38-9910	Baldwin	54	45-6307	
62-363		38-9910		64	45-6307	
62-373		38-9910		U6	45-6307	
62-374		38-9910	Belmont	415A	38-9910	
62-376		38-9910		415B	38-9910	
62-425		38-9910		489A	38-9910	
62-463		38-9910		489B	38-9910	
62-465		38-9910		504	38-9910	
62-466		38-9910		504A	38-9910	
62-253	45-6307	566		45-6307		
62-650	38-9910	567A		45-6307		
165L	45-6307	577		45-6307		
Arvin	5	45-6307		661	45-6307	
	6	45-6307		666	45-6307	
	7	45-6307	666A	45-6307		
	7A(RE44)	45-6307	666B	45-6307		
	8A(RE45)	45-6307	667	45-6307		
	9A	45-6307	668	45-6307		
	17A	45-6307	677	45-6307		
	17B	45-6307	677A	45-6307		
	17C	45-6307	677B	45-6307		
	18	45-6307	677C	45-6307		
	18FW	45-6307	706-378	38-9910		
	19	45-6307	706-391	38-9910		
	22A	45-6307	706-398	38-9910		
	27	45-6307	804	38-9910		
	28	45-6307	823H	38-9910		
	28EM	45-6307	881	45-6307		
	29	45-6307	Bosch	79	45-6307	
	32	45-6307		79C	45-6307	
	33	45-6307		337	45-6307	
	33DM	45-6307				
	37	45-6307				



MODEL LISTINGS FOR VIBRATOR REPLACEMENT (Cont.)

MANUFACTURER	MODEL	PHILCO VIBRATOR PART No.	MANUFACTURER	MODEL	PHILCO VIBRATOR PART No.		
Bosch (cont.)	524A	45-6307	Clarion (cont.)	110	45-6307		
	536	45-6307		453	38-9910		
	536B	45-6307		462	38-9910		
	634	45-6307		646	45-6307		
	634A	45-6307		746	45-6307		
	634A(2)	45-6307		846	45-6307		
	636	45-6307		AR100	45-6307		
	637	45-6307		Colonial Continental	350	45-6307	
	735	45-6307			6A	45-6307	
	736	45-6307			6C	45-6307	
	737	45-6307			6D	45-6307	
	738	45-6307			7A	45-6307	
	838	45-6307			55	45-6307	
	858	45-6307			66	45-6307	
	VP-A(ED1)	45-6307			69	45-6307	
	189(VPA)	45-6307			77	45-6307	
	Cadillac	7238350			38-9912	78	45-6307
		Champion			5	45-6307	88
	500				45-6307	512-6D	45-6307
501	45-6307		660		45-6307		
600	45-6307		770		45-6307		
601	45-6307		880		45-6307		
Chevrolet	985100	45-6307	950-6A		45-6307		
	985200	45-6307	965-6A		45-6307		
	985252	38-9912	46		45-6307		
	985253	38-9912	Coronado		60	45-6307	
	985254	38-9912		6C1	45-6307		
	985255	38-9912		22CM756	45-6307		
	985283	38-9912		26R1	45-6307		
	985284	38-9912		46L1	45-6307		
	985424	38-9912		500	45-6307		
	985425	45-6307		566	45-6307		
	985426	38-9912		666	45-6307		
	985536	45-6307		667	45-6307		
	985537	45-6307		677A	45-6307		
	985538	45-6307		677B	45-6307		
	985696	45-6307		803A	45-6307		
	985697	45-6307		803B	45-6307		
	Chrysler	B6F		83-0026	Crosley	A156	45-6307
		B9F		83-0026		A157	45-6307
		CDS		83-0026		A158	45-6307
CGD		83-0026		A167		45-6307	
CGDU		83-0026		A168		45-6307	
CRD		83-0026		A169		45-6307	
CT2		83-0026	A177	45-6307			
CT5		83-0026	A196	45-6307			
CT10		83-0026	A258	45-6307			
CT11		83-0026	A259	45-6307			
C1423		83-0026	A266	45-6307			
C1450		83-0026	A267	45-6307			
C1451		83-0026	A268	45-6307			
C1452		83-0026	A358	45-6307			
C1540		83-0026	A368	45-6307			
C1542		83-0026	B46	38-9910			
C1550		83-0026	B587A	45-6307			
C1606		83-0026	B667A	45-6307			
C1608		83-0026	B667M	45-6307			
C1708		83-0026	C159	45-6307			
C1808	83-0026	C180	45-6307				
C1908	83-0026	416	38-9910				
C4608 (MOPAR 802)	83-0026	435	38-9910				
Clarion	31	38-9910	546	38-9910			
	37	38-9910	587	45-6307			
	60	45-6307	636	38-9910			
	61	45-6307	667	45-6307			
	70	45-6307	5587	45-6307			
	71	45-6307	6615	38-9910			
	80	45-6307	Delco	6-3	38-9912		
	81	45-6307		500	45-6307		
				630	45-6307		



MODEL LISTINGS FOR VIBRATOR REPLACEMENT (Cont.)

MANUFACTURER	MODEL	PHILCO VIBRATOR PART No.	MANUFACTURER	MODEL	PHILCO VIBRATOR PART No.		
Delco (cont.)	631	45-6307	Firestone (cont.)	1314(R131)	45-6307		
	631A	45-6307		1332(R133)	45-6307		
	632	45-6307		H7424	38-9910		
	633	45-6307		7407-3(536)	38-9912		
	R640	38-9912		7407-6	45-6307		
	R641	38-9912		7425	45-6307		
	R642	38-9912		S-7407-5	38-9912		
	R643	38-9912		S-7407-8	38-9912		
	R644	38-9912		S-7424-3	38-9910		
	R663	38-9912		S-7425-3	45-6307		
	R664	38-9912		S-7428-1	38-9910		
	R665	38-9912		Traveler	45-6307		
	R666	38-9912					
	R667	38-9912					
	R668	38-9912					
	R669	38-9912					
	R673	38-9912					
	R675	38-9912					
	R676	38-9912					
	R677	38-9912					
	R678	38-9912					
	R685	38-9912					
	R686	38-9912					
	R687	38-9912					
	R688	38-9912					
	R695	38-9912					
	R696	38-9912					
	R697	38-9912					
	Detrola	111		45-6307	Ford	6MF90	45-6307
		112		45-6307		6MF490	45-6307
		166		45-6307		6MF490	38-9910
		267		45-6307		FN	83-0026
		346		45-6307		FT6	83-0026
1112		45-6307	FT9	83-0026			
Echophone	1935		F1440	83-0026			
	Models	45-6307	F1440X	83-0026			
Emerson	E	45-6307	F1442	83-0026			
	E123	45-6307	F1442X	83-0026			
	E128	45-6307	F1540	83-0026			
	F122	45-6307	F1542	83-0026			
	F133	45-6307	F1640	83-0026			
	F135	45-6307	F1641	83-0026			
	F141	45-6307	F1740	83-0026			
	G127	45-6307	F1840	83-0026			
	U154	45-6307	F1942	83-0026			
	V155	45-6307					
	2A	45-6307					
	6A	45-6307					
	AS179(AS)	38-9910					
	Fada	166	45-6307	Garod	B37	45-6307	
		266	45-6307		General	801	45-6307
		266SD	45-6307	802		45-6307	
		266SG	45-6307	803		45-6307	
267		45-6307	804	45-6307			
267SD		45-6307	805	45-6307			
267SF		45-6307	806	45-6307			
267SG		45-6307	807	45-6307			
267X		45-6307	GE	45-6307			
Fairbanks Morse		4A	38-9910	D72	45-6307		
	4B	38-9910	H5M	45-6307			
	6C	38-9910	JA62	45-6307			
	6CC-2B	38-9910	JA64	45-6307			
	8CT-4B	38-9910	K6M	45-6307			
	43C-1B	38-9910	K7M	45-6307			
	43T-1B	38-9910	M58	45-6307			
	73C-3B	38-9910	M60	45-6307			
Firestone	73T-3B	38-9910	M68	45-6307			
	54	45-6307	M69	45-6307			
	64	45-6307	M602	45-6307			
	1182(R118)	45-6307	N60	45-6307			
General Electric			General Electric	U51	38-9910		
				U55	38-9910		
	General Motors (Canada)			General Motors (Canada)	396	45-6307	
					397	45-6307	
					650	45-6307	
					651	45-6307	
					750	45-6307	
					751	45-6307	
	G. M. Truck			G. M. Truck	7233966	38-9912	
					7233967	38-9912	
Goodrich			Goodrich	50	45-6307		
				60	45-6307		
				65	45-6307		
				80	45-6307		
				90	45-6307		
Goodyear			Goodyear	415A	38-9910		
				415B	38-9910		
				489	38-9910		

MODEL LISTINGS FOR VIBRATOR REPLACEMENT (Cont.)

MANUFACTURER	MODEL	PHILCO VIBRATOR PART No.	MANUFACTURER	MODEL	PHILCO VIBRATOR PART No.	
Goodyear (cont.)	504A	38-9910	Knight (cont.)	E10825	38-9910	
	010219	38-9910		E10826	38-9910	
	015110	38-9910		E10827	38-9910	
	015120	38-9910		E10829	38-9910	
	015121	38-9910		E10830	38-9910	
	019221	38-9910		E10831	38-9910	
	915111	38-9910		E10832	38-9910	
	Goodyear (Wings)	566		45-6307	E10882	45-6307
		661		45-6307	E10883	45-6307
		666		45-6307	E10884	45-6307
667		45-6307	E10885	45-6307		
01019		45-6307	E10886	45-6307		
01020		45-6307	E10887	45-6307		
010110		45-6307	E10890	45-6307		
015130		45-6307	E10891	45-6307		
015131		45-6307	EL-719	38-9910		
101500		45-6307	E1-720	38-9910		
100502		45-6307	E1-721	38-9910		
101501		45-6307	E1-727	38-9910		
101502		45-6307	H9726	45-6307		
Graham		G1418	83-0026	H9766	45-6307	
		G1436	83-0026	H9897	45-6307	
	G1528	83-0026	Lafayette	B51	45-6307	
	G1628	83-0026		B90	45-6307	
Grunow	508	45-6307		C60	45-6307	
	509 (5AB)	45-6307		D37	45-6307	
	614	45-6307		D45	45-6307	
	618	45-6307		D46	45-6307	
Hudson	DB2	45-6307		EB17	45-6307	
	Hudson Terraplane	H6		45-6307	EB17A	45-6307
SA38		45-6307		EB67	45-6307	
666		45-6307		JA1	45-6307	
668		45-6307		JA2	45-6307	
680		45-6307		S9	45-6307	
Hupmobile	HD6	83-0026		S79	45-6307	
	H(HHD)	83-0026		Household	38-9910	
	HRD	83-0026		Lincoln	LHX	83-0026
	HT2, J	83-0026	LT14X3		83-0026	
	NJD, SJD		LT14X4		83-0026	
	HT11	83-0026	L1420		83-0026	
	HT11X	83-0026	L1424		83-0026	
Knight	A9780	45-6307	L1425		83-0026	
	A9781	45-6307	L1427		83-0026	
	A9782	45-6307	L1429		83-0026	
	A9783	45-6307	L1460		83-0026	
	A9784 (B6, B7, B8)	45-6307	L1560		83-0026	
	A9820(B102)	45-6307	L1660	83-0026		
	A9880(U6)	45-6307	L1760	83-0026		
	B10550	45-6307	T14	83-0026		
	B10551	45-6307	Marconi	69	45-6307	
	B10552	45-6307		95	45-6307	
	B10575	45-6307		165	45-6307	
	B10728	38-9910		291	45-6307	
	B10730	38-9910		294	45-6307	
	B10732	38-9910	N103	45-6307		
	B10735	45-6307	Midwest	5-36	45-6307	
B10742	38-9910	6-37		45-6307		
B10744	38-9910	Motorola	8-30	45-6307		
B10780	38-9910		8-40	45-6307		
B10782	45-6307		8-50	45-6307		
B10784	45-6307		8-60	45-6307		
B10786	45-6307		8-70	45-6307		
B10790	45-6307		8-80	45-6307		
B10791	45-6307		9-29	45-6307		
E10751	45-6307		9-44	45-6307		
E10752	45-6307		9-49	45-6307		
E10786	45-6307		9-69	45-6307		
E10822	38-9910		15-F	45-6307		
			16C	45-6307		



MODEL LISTINGS FOR VIBRATOR REPLACEMENT (Cont.)

MANUFACTURER	MODEL	PHILCO VIBRATOR PART No.	MANUFACTURER	MODEL	PHILCO VIBRATOR PART No.		
Motorola (cont.)	17DA	45-6307	Nash Lafayette	AC3789	45-6307		
	19B	45-6307		AC4289	38-9910		
	20P	45-6307		AC4389	45-6307		
	21L	45-6307	Oldsmobile	982043	38-9912		
	22S	45-6307		982044	38-9912		
	24K	45-6307		982045	38-9912		
	25N	45-6307		982083	38-9912		
	26C	45-6307		982084	38-9912		
	26C7	45-6307		982085	38-9912		
	27D	45-6307		982126	38-9912		
	28Q	45-6307		982127	38-9912		
	29B	45-6307		982153	38-9912		
	29B-6	45-6307		982161	38-9912		
	30P	45-6307		982216	38-9912		
	34	45-6307		Packard	PB	83-0026	
	34K6	45-6307			PHX	83-0026	
	34K7	45-6307			PT5	83-0026	
	35	45-6307	PT14		83-0026		
	37D1	45-6307	P1417		83-0026		
	37D2	45-6307	P1421		83-0026		
	39B	45-6307	P1422		83-0026		
	39B2	45-6307	P1426		83-0026		
	49BR2	38-9910	P1430		83-0026		
	56T	39-9910	P1432		83-0026		
	56Y	38-9910	F1432H		83-0026		
	45	45-6307	P1439		83-0026		
	50	45-6307	P1517		83-0026		
	60	45-6307	P1530		83-0026		
	65	45-6307	P1535	83-0026			
	70	45-6307	P1617	83-0026			
	80	45-6307	P1630	83-0026			
	90	45-6307	P1635	83-0026			
	180	45-6307	P4635	83-0026			
	300	45-6307	P4735	83-0026			
	400	45-6307	Packard Radio Co.	6	45-6307		
	450	45-6307		Parmark	76	38-9910	
	500	45-6307			Philco	5	83-0026
	700	45-6307				6	83-0026
	701	45-6307				6F	83-0026
	Companion	45-6307				7	83-0026
	Golden Voice	45-6307				8	83-0026
	Police and	F8030				9	83-0026
	police	FMR13				9F	83-0026
	cruiser	FMR13V				10 Code 121	83-0026
	models	P69-12				10 Code 122	83-0026
	9-24	45-6307				11 Code 121	83-0026
	9-24A	45-6307				11 Code 122	83-0026
	35N	45-6307				12	83-0026
	250	45-6307	38-35			83-0026	
	251	45-6307	38-40	83-0026			
	350	45-6307	629	83-0026			
	Nash	6MN695	45-6307	700	83-0026		
		NCD	83-0026	800 Code 121	83-0026		
		NDD	83-0026	800 Code 122	83-0026		
		NDD-122 (D122)	83-0026	802	83-0026		
		NJD	83-0026	805	83-0026		
		NQD	83-0026	806	83-0026		
		NT7	83-0026	808	83-0026		
		NT8	83-0026	809	83-0026		
		NT12	83-0026	810 PA	83-0026		
NT12X		83-0026	810 PB	83-0026			
NT12X2		83-0026	810 PV	83-0026			
NT15		83-0026	811 P	83-0026			
NT15X		83-0026	811 PA	83-0026			
N1418		83-0026	811 PB	83-0026			
N1433		83-0026	811PV	83-0026			
N1434		83-0026	816	83-0026			
N1514		83-0026					
N1524		83-0026					



MODEL LISTINGS FOR VIBRATOR REPLACEMENT (Cont.)

MANUFACTURER	MODEL	PHILCO VIBRATOR PART No.	MANUFACTURER	MODEL	PHILCO VIBRATOR PART No.
Philco (cont.)	816 B	83-0026	Philco (cont.)	C1450	83-0026
	816 C	83-0026		C1451	83-0026
	816 P	83-0026		C1452	83-0026
	817	83-0026		C1540	83-0026
	817 B	83-0026		C1542	83-0026
	817 C	83-0026		C1550	83-0026
	817 P	83-0026		C1606	83-0026
	818	83-0026		C1608	83-0026
	818 K	83-0026		C1708	83-0026
	819	83-0026		C1808	83-0026
	819 H	83-0026		C1908	83-0026
	826	83-0026		C4608	83-0026
	827	83-0026		C4608(122)	83-0026
	827 K	83-0026		D(NDD, SDD)	83-0026
	828	83-0026		DP	83-0026
	828 K	83-0026		DPV	83-0026
	920	83-0026		E122(MFD122)	83-0026
	921	83-0026		EF	83-0026
	922	83-0026		EG	83-0026
	926	83-0026		FN	83-0026
	927	83-0026		FT-8	83-0026
	928	83-0026		FT-9	83-0026
	928 K	83-0026		F1440	83-0026
	931	83-0026		F1440X	83-0026
	932	83-0026		F1442	83-0026
	933	83-0026		F1442X	83-0026
	936	83-0026		F1540	83-0026
	937	83-0026		F1542	83-0026
	938	83-0026		F1640	83-0026
	938 K	83-0026		F1641	83-0026
	AC206	83-0026		F1740	83-0026
	AC206(122)	83-0026		F1840	83-0026
	AC236	83-0026		F1942	83-0026
	AC266	83-0026		G(CG D)	83-0026
	AC989	83-0026		G122(HGD122, HGD122)	83-0026
	AC989(122)	83-0026		G1418	83-0026
	AC1089	83-0026		G1436	83-0026
	AC1189	83-0026		G1528	83-0026
	AC1289	83-0026		G1628	83-0026
	AC1989	83-0026		H122(HHD122, P4D)	83-0026
	AR-1	83-0026		H(HHD)	83-0026
	AR-2	83-0026		HGD	83-0026
	AR-3	83-0026		HGD122(G122)	83-0026
	AR-4	83-0026		HRD	83-0026
	AR-5	83-0026		HRD122(R122)	83-0026
	AR-6	83-0026		HT2	83-0026
	AR-7	83-0026		HT11	83-0026
	AR-8	83-0026		HT11X	83-0026
	AR-9	83-0026		(NJD, SJD)	83-0026
	AR-10	83-0026		J122(NJD122, SJD122)	83-0026
	AR-40	83-0026		LHX	83-0026
	AR-45	83-0026		LT14X3	83-0026
	AR-50	83-0026		LT14X4	83-0026
	AR-55	83-0026		L1420	83-0026
	AR-65	83-0026		L1424	83-0026
	AR-75	83-0026		L1425	83-0026
B(PBD)	83-0026	L1427	82-0026		
B6F	83-0026	L1429	83-0026		
B9F	83-0026	L1460	83-0026		
C(NCD, SCD)	83-0026	L1560	83-0026		
C122 (3CD122)	83-0026	L1660	83-0026		
CBD122(G122)	83-0026	L1760	83-0026		
CDS	83-0026	L1761	83-0026		
CGD	83-0026	ME	83-0026		
CGDU	83-0026	MED	83-0026		
CRD	83-0026	MED(E)	83-0026		
CRD122(R122)	83-0026	MED122(E122)	83-0026		
CT2	83-0026	MT3	83-0026		
CT5	83-0026	MT14X4	83-0026		
CT10	83-0026	M1412	83-0026		
CT11	83-0026	M1435	83-0026		
C1423	83-0026	NCD	83-0026		



MODEL LISTINGS FOR VIBRATOR REPLACEMENT (Cont.)

MANUFACTURER	MODEL	PHILCO VIBRATOR PART No.	MANUFACTURER	MODEL	PHILCO VIBRATOR PART No.	
Philco (cont.)	NDD	83-0026	Philco (cont.)	S4625	83-0026	
	NDD122(122)	83-0026		S4626	83-0026	
	NJD	83-0026		S4627	83-0026	
	NJD122(D122)	83-0026		S4824	83-0026	
	NQD	83-0026		T2	83-0026	
	NT7	83-0026		T3	83-0026	
	NT8	83-0026		T5	83-0026	
	NT12	83-0026		T6	83-0026	
	NT12X	83-0026		T7	83-0026	
	NT12X2	83-0026		T8	83-0026	
	NT15	83-0026		T9	83-0026	
	NT15X	83-0026		T10	83-0026	
	TB	83-0026		T11	83-0026	
	PBD	83-0026		T12	83-0026	
	PHD(H122)	83-0026		T12X	83-0026	
	PHX	83-0026		T14	83-0026	
	PT5	83-0026		T14X	83-0026	
	PT14	83-0026		T15	83-0026	
	PT14X	83-0026		T15X	83-0026	
	P1417	83-0026		W1419	83-0026	
	P1421	83-0026		37-34	38-9910	
	P1422	83-0026		37-3624B	38-9910	
	P1426	83-0026		37-3624X	38-9910	
	P1430	83-0026		37-624	38-9910	
	P1432	83-0026		38-34	38-9910	
	P1432H	83-0026		38-39	38-9910	
	P1439	83-0026		38-C624T	38-9910	
	P1517	83-0026		38-C624X	38-9910	
	P1530	83-0026		39-744	38-9910	
	P1535	83-0026		40-748	38-8810	
	P1617	82-0026		821	38-9910	
	P1630	83-0026		821 PV	38-9910	
	P1635	83-0026		UN6-100	45-6307	
	P1835	83-0026		UN6-400	45-6307	
	P1935	83-0026		UN6-450	45-6307	
	P4635	83-0026		UN6-500	45-6307	
	P4735	83-0026		UN6-550	45-6307	
	Q(NQD, SQD)	83-0026		CR2	45-6307	
	R(CRD, HRD)	83-0026		CR4	45-6307	
	R122(CRD122, HRD122)	83-0026		CR6	45-6307	
	RT3(S485)	83-0026		CR8	45-6307	
	RT3	83-0026		CR9	83-0026	
	RT14X	83-0026		CR10	45-6307	
	R1415	83-0026		CR12	45-6307	
	SCD	83-0026				
	SC122(122)	83-0026		Pierce Airo	A606	45-6307
	SDD (D)	83-0026			A607LW	45-6307
	SJD	83-0026				
	SJD(J122)	83-0026				
	SQD	83-0026		Pierce Airo-Dewald (United Scientific)	A604	45-6307
	ST3	83-0026			A605	45-6307
	ST7X	83-0026			517	45-6307
	ST12	83-0026			517R	45-6307
	ST15	83-0026			527	45-6307
	S1415	83-0026			605	45-6307
	S1416	83-0026			606	45-6307
	S1431	83-0026			607	45-6307
	S1437	83-0026			617	45-6307
	S1516	83-0026			702	45-6307
	S1526	83-0026				
	S1616	83-0026		Pierce Arrow	MED	83-0026
	S1622	83-0026			MT3	83-0026
	S1626	83-0026			MT14X4	83-0026
	S1722	83-0026			M1412	83-0026
	S1724	83-0026			M1435	83-0026
S1726	83-0026		REO	83-0026		
S1824	83-0026		RT3	83-0026		
S1825	83-0026		RT14X	83-0026		
S1826	83-0026					
S1925	83-0026	Pilot	605	45-6307		
S1926	83-0026		H64	45-6307		
S4624	83-0026		H6204(H6200)	45-6307		

MODEL LISTINGS FOR VIBRATOR REPLACEMENT (Cont.)

MANUFACTURER	MODEL	PHILCO VIBRATOR PART No.	MANUFACTURER	MODEL	PHILCO VIBRATOR PART No.
Pontiac	983526	38-9912	Silvertone (cont.)	4550	45-6307
	983527	38-9912		4599	38-9910
	983534	38-9912		4600	38-9912
	983569	38-9912		4601(101, 458)	38-9912
	983570	38-9912		4614(101, 497)	45-6307
	983616	38-9912		4622	38-9910
	983617	38-9912		4623	38-9910
	983679	38-9912		4640(101, 476)	38-9910
	983776	38-9912		4643	38-9910
	RCA Victor	AC3789		45-6307	4650(101, 476)
H6		45-6307	4651(101, 497)	38-9910	
M50		45-6307	4700	45-6307	
M60		45-6307	4722	38-9910	
M109		45-6307	4723	38-9910	
8M		45-6307	4743	38-9910	
8M1		45-6307	4740(101, 476)	38-9910	
8M2		45-6307	4750(101, 476)	38-9910	
8QB		45-6307	6000	38-9912	
8QBK		45-6307	6001	38-9912	
9M1		45-6307	6005	38-9910	
9M2(RC357A)		45-6307	6070	38-9910	
67M		45-6307	6072	38-9910	
Imperial		45-6307	6073	45-6307	
Royal		45-6307	6074	45-6307	
Sentinel	7M	45-6307	6076	38-9910	
	10M	45-6307	6077	38-9910	
	10MF	45-6307	6079	45-6307	
	11M	45-6307	6100	38-9912	
	100XC	45-6307	6101	38-9912	
	100XT	45-6307	6104	45-6307	
	144XC	45-6307	6171	38-9910	
	144XT	45-6307	6172	38-9910	
	197X	45-6307	6173	45-6307	
	7163	45-6307	6190	45-6307	
	5500	45-6307	6214	38-9910	
	Silvertone	46B	38-9910	6218	45-6307
		470(101, 476)	38-9910	6270	38-9910
		566	45-6307	6271	45-6307
		666	45-6307	6301	45-6307
1869		45-6307	6302(101, 598)	38-9912	
1869X		45-6307	6368	45-6307	
1871		45-6307	6392	45-6307	
1949		45-6307	7128	45-6307	
1949A		45-6307	7128A	38-9910	
3400		45-6307	7157	45-6307	
4128		45-6307	7167	45-6307	
4405		45-6307	7176	38-9910	
4405A		38-9910	Sparton	D686	45-6307
4406		45-6307		H686	45-6307
4407		45-6307		676	45-6307
4418	38-9910	686		45-6307	
4419	38-9910	649-6L		45-6307	
4421 (104, 127)	38-9910	649-6S		45-6307	
4428	45-6307	677		45-6307	
4428A	38-9910	678		45-6307	
4430	38-9910	699		45-6307	
4433	38-8810	6F1D		45-6307	
4434(104, 127)	38-9910	Stewart Warner	1171	45-6307	
4441	38-9910		1172	45-6307	
4448	45-6307		1181	45-6307	
4448A	38-9910		1182	45-6307	
4450	45-6307		1183	45-6307	
4451	38-9910		1311 to 1319(R131)	45-6307	
4453	38-9910		1332(R133)	45-6307	
4459	38-9910		4061(406)	45-6307	
4519	38-9910		4181	38-9910	
4521(104, 127)	38-9910		4185(R415, R418)	38-9910	
4528A	38-9910	Studebaker	SCD	83-0026	
4548	45-6307		SJD	83-0026	
4548A	38-9910		SQD	83-0026	



MODEL LISTINGS FOR VIBRATOR REPLACEMENT (Cont.)

MANUFACTURER	MODEL	PHILCO VIBRATOR PART No.	MANUFACTURER	MODEL	PHILCO VIBRATOR PART No.	
Studebaker (cont.)	ST3	83-0026	Walgreen	R15	38-9910	
	ST7X	83-0026		R66	38-9910	
	ST12	83-0026	550	45-6307		
	ST15	83-0026	Warwick	560	45-6307	
	S1416	83-0026		550	45-6307	
	S1431	83-0026		611	45-6307	
	S1437	83-0026		646	45-6307	
	S1516	83-0026		659	45-6307	
	S1526	83-0026		660	45-6307	
	S1616	83-0026		665	45-6307	
	S1622	83-0026		746	45-6307	
	S1626	83-0026		747	45-6307	
	S1722	83-0026		846	45-6307	
	S1724	83-0026		9-59	45-6307	
	S1726	83-0026		9-627	45-6307	
	S1824	83-0026		Westinghouse	WR260	45-6307
	S1825	83-0026			WR500	45-6307
	S1826	83-0026	WR501		45-6307	
	S1925	83-0026	WR502		45-6307	
	S1926	83-0026	WR503	45-6307		
	S4624	83-0026	Willys	6MV693	45-6307	
	S4625	83-0026		Willys-Overland	W1419	83-0026
	S4626	83-0026	Zenith		5J217	45-6307
	S4627	83-0026		5J247	45-6307	
S4824	83-0026	5J255(5524)		45-6307		
Trav-ler	54	45-6307		5M90(5510)	45-6307	
	64	45-6307		5M191(5520)	45-6307	
	179	45-6307		5M291(5527)	45-6307	
	180	45-6307		5M294(5530)	45-6307	
	542	45-6307		6J230	45-6307	
	560	45-6307		6J257(5642)	45-6307	
	570E	45-6307		6J322	45-6307	
	576B	45-6307		6J357(5654)	45-6307	
	601	45-6307		6M90D	45-6307	
	610	45-6307		6M90S(5630)	45-6307	
	620	45-6307		6M91D	45-6307	
	621	45-6307	6M91S(5631)	45-6307		
	642	45-6307	6M92(5632)	45-6307		
	660	45-6307	6M192	45-6307		
	670	45-6307	6M193	45-6307		
	679	45-6307	6M194	45-6307		
	680	45-6307	6M195(5637)	45-6307		
	710	45-6307	6M292	45-6307		
	711	45-6307	6M293(5645), (5805)	45-6307		
	6 tube auto	45-6307	6M295(5650)	45-6307		
	6 tube battery A.C.	45-6307	6M390	45-6407		
	7 tube auto	45-6307	6MF490	45-6307		
	Truetone	D709	45-6307	6MF590	45-6307	
		D734	45-6307	6MF591	45-6307	
D737		45-6307	6MN495	45-6307		
D737B		45-6307	6MN595	45-6307		
D737C		45-6307	6MM496	38-9910		
D743		45-6307	4V31	38-9910		
D743W		45-6307	4V59(5405)	38-9910		
D744		45-6307	6V27	38-9910		
D747		45-6307	6V62(5621)	39-9910		
S737		45-6307	7J232	45-6307		
S737C		45-6307	7J250(5711)	45-6307		
S743		45-6307	7J323	45-6307		
716		45-6307	7J368(5715)	45-6307		
717		45-6307	7M91D	45-6307		
1312(R131)		45-6307	7M91S(5708)	45-6307		
Universal Battery Co.		60	45-6307	7ML592	45-6307	
		70	45-6307	7MN596	45-6307	
		80	45-6307	8M195(5803)	45-6307	
	801	45-6307	863	45-6307		
	802	45-6307	664(5510)	45-6307		
	803	45-6307	666(5616)	45-8307		
	804	45-6307	668(5626)	45-8307		
	805	45-6307	680(5617)	45-8307		
	806	45-6307				
	807	45-6307				

PHILCO UNIVERSAL SPEAKERS

In Philco universal replacement speakers, resonances are held to close tolerances for exact duplication of original speaker tone. Hum-bucking coils, dust-proofed units, and, in the p-m type, alnico V magnets for less weight with more strength, are but a few features of Philco speakers.

Laboratory-approved frequency response. Standard mounting dimensions and connectors. Voice-coil impedance: 3.2 ohms.

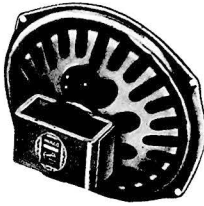

AUTO RADIO

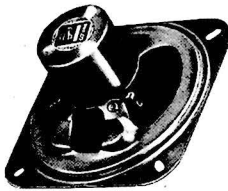

SQUARE FRAME



PERMANENT MAGNET



ELECTRODYNAMIC

ELECTRODYNAMIC TYPE

PART NO.	DIAMETER IN INCHES	D-C FIELD RESISTANCE IN OHMS	VOICE-COIL SIZE	LIST PRICE
36-1469-1	4	500	9/16"	\$4.25
45-0001-1	4	3000	9/16"	5.00
45-0003-1	4 x 6 (oval)	450	9/16"	5.60
45-0003-2	4 x 6 (oval)	1700	9/16"	5.60
45-0002-3	5	450	9/16"	5.40
45-0002-4	5	1000	9/16"	5.40
45-0002-5	5	1700	9/16"	5.40
45-0002-7	5	2500	9/16"	5.40
45-0002-2	5 (auto radio)	4	9/16"	5.00
45-0004-1	6	1000	1"	6.25
45-0004-2	6	1700	1"	6.25
45-0004-3	6	2500	1"	6.25
36-1622-1	6 x 9 (auto radio)	4	1"	6.75
36-1609-3	7 (auto radio)	4	1"	5.50
45-0005-1	8	1000	1"	8.00
45-0005-2	8	1700	1"	8.00
45-0005-4	8	2500	1"	8.00
45-0007-1	10	1000	1"	12.00
45-0007-2	10	1700	1"	12.00
45-0007-3	10	2500	1"	12.00
45-0006-1	12	1000	1"	14.00
45-0006-5	12	1700	1"	14.00
45-0006-3	12	2500	1"	14.00

PERMANENT-MAGNET TYPE

PART NO.	DIAMETER IN INCHES	MAGNETIC WEIGHT IN OUNCES	VOICE-COIL SIZE	LIST PRICE
45-0001	4	.68	9/16"	\$4.00
45-0003	4 x 6 (oval)	1.47	9/16"	5.25
45-0002	5 (Round Frame)	1.47	9/16"	4.50
45-0002-1	5	3.16	3/4"	6.50
45-0004	6	3.16	3/4"	6.50
45-0005	8	3.16	3/4"	8.00
45-0007	10	3.16	1"	13.00
45-0006	12	3.16	1"	14.50

PHILCO UNIVERSAL POWER TRANSFORMERS

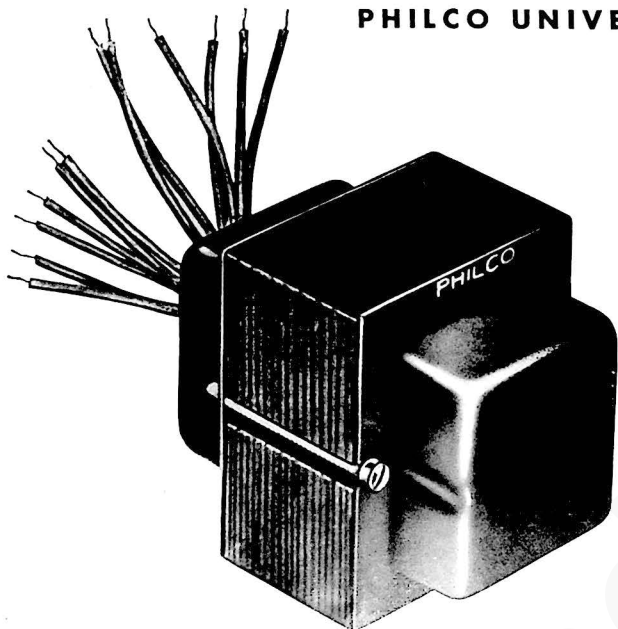

The Philco universal-power-transformer line includes types to fill every need—either in circuits of original design or in circuits requiring replacement units.

Features of the line include:

- Vertical and horizontal-mounting types
- Types for 115-volt and 230-volt operation
- Types for 25-cycle, 50-cycle and 60-cycle operation
- Vibrator-transformer types
- Rectifier socket mounted on some transformers
- Shielded and unshielded types

Oversized core and high copper content in windings insure low heat rise and excellent regulation. Leads are 15 inches long, and RMA color-coded.

* Denotes center tap.

PART NO.	SECONDARY		RECTIFIER		FIL. NO. 1		FIL. NO. 2		FIL. NO. 3		DIMENSIONS IN INCHES			MTG. CNTRS. IN INCHES	LIST PRICE
	A.C. VOLTS	D.C. M.A.	VOLTS	AMP.	VOLTS	AMP.	VOLTS	AMP.	VOLTS	AMP.	H	L	W		
VERTICAL-MOUNTING TYPES (115 VOLTS — 60 CYCLES)															
32-7979	410	40	6.4	2.0							3 $\frac{1}{8}$	2 $\frac{1}{2}$	2 $\frac{3}{8}$	2 $\frac{1}{4}$ x 1 $\frac{3}{8}$	\$4.75
32-7826	500	50	6.7	2.0							3 $\frac{1}{8}$	2 $\frac{1}{8}$	2 $\frac{1}{2}$	2 $\frac{1}{4}$ x 1 $\frac{1}{8}$	6.50
32-8157	575	75	5.0	2.0	6.4*	2.0					3 $\frac{3}{8}$	2 $\frac{1}{2}$	2 $\frac{3}{8}$	2 $\frac{1}{8}$ x 2 $\frac{1}{4}$	6.50
32-7180	625	50	5.0	2.0	6.3	1.5					3 $\frac{3}{8}$	2 $\frac{1}{2}$	2 $\frac{3}{8}$	2 $\frac{1}{8}$ x 2 $\frac{1}{8}$	8.50
32-8243	650	75	6.4	3.45	6.4*	0.3					3 $\frac{3}{8}$	2 $\frac{1}{2}$	4	2 $\frac{1}{8}$ x 2 $\frac{1}{4}$	8.75
6072	650	125	5.0	2.0	2.5*	12.25	2.5*	3.45			5 $\frac{3}{8}$	3 $\frac{3}{4}$	3 $\frac{7}{8}$	3 $\frac{1}{8}$ x 3 $\frac{1}{8}$	14.75
32-8248	675	100	5.0	2.0	6.4	2.6	6.4*	0.6			3 $\frac{7}{8}$	3 $\frac{1}{2}$	3 $\frac{3}{8}$	2 $\frac{1}{2}$ x 2 $\frac{1}{4}$	10.00
5594	725	125	5.0	2.0	2.68*	3.45	2.67*	14.0			5	3 $\frac{3}{8}$	4	3 $\frac{1}{8}$ x 3 $\frac{1}{4}$	17.50
32-7111	750	150	5.0	2.0	6.3*	3.75					5 $\frac{3}{8}$	4	3 $\frac{3}{4}$	3 $\frac{3}{8}$ x 3 $\frac{1}{8}$	11.00
VERTICAL-MOUNTING TYPES, UNCASED (115 VOLTS — 60 CYCLES)															
32-8183	510	50	6.4	3.5							3 $\frac{1}{8}$	2 $\frac{1}{2}$	2 $\frac{1}{4}$	2 $\frac{1}{8}$ x 1 $\frac{3}{8}$	5.00
32-8234	560	65	6.4	3.3							3 $\frac{3}{8}$	2 $\frac{1}{2}$	2 $\frac{1}{8}$	1 $\frac{1}{8}$ x 2 $\frac{1}{8}$	6.00
HORIZONTAL-MOUNTING TYPES (115 VOLTS — 60 CYCLES)															
32-8221	525	75	6.4	4.0	6.4*	0.3					3 $\frac{3}{8}$	2 $\frac{1}{2}$	3	2 $\frac{1}{4}$	7.50
32-8231	550	75	6.4	4.3							3	3 $\frac{1}{4}$	2 $\frac{1}{2}$	2 $\frac{1}{4}$ x 2 $\frac{1}{8}$	6.50
32-7552	575	50	5.0	2.0	6.3*	1.5					2 $\frac{1}{2}$	2 $\frac{1}{2}$	3	2 $\frac{1}{4}$	5.75
32-8282	650	125	5.0	3.0	6.4	4.2	6.4*	0.3			3 $\frac{1}{2}$	3 $\frac{1}{8}$	4 $\frac{1}{4}$	3	13.00
32-8286	650	150	5.0	3.0	6.4*	1.5	6.4	6.0			3 $\frac{7}{8}$	3 $\frac{3}{4}$	4 $\frac{1}{2}$	3 $\frac{3}{4}$ x 3	15.00
32-7381	675	75	5.0	2.0	6.3*	2.2					3 $\frac{3}{8}$	3	3 $\frac{3}{8}$	2 $\frac{1}{2}$ x 3 $\frac{1}{8}$	8.25
32-8303	690	390	5.0	6.0	6.5	7.5	6.5	2.5			4 $\frac{1}{4}$	3 $\frac{1}{2}$	4 $\frac{1}{2}$	3 $\frac{1}{4}$	26.00
32-8186	750	150	5.0	2.0	6.4	5.2	6.4*	0.15	2.5	2.5	4	4	4 $\frac{1}{2}$	3 $\frac{1}{8}$ x 3 $\frac{1}{4}$	18.00



PHILCO UNIVERSAL POWER TRANSFORMERS (Cont.)

PART NO.	SECONDARY		RECTIFIER		FIL. NO. 1		FIL. NO. 2		FIL. NO. 3		DIMENSIONS IN INCHES			MTG. CNTRS. IN INCHES	LIST PRICE
	A.C. VOLTS	D.C. M.A.	VOLTS	AMP.	VOLTS	AMP.	VOLTS	AMP.	VOLTS	AMP.	H	L	W		
HORIZONTAL-MOUNTING TYPES, WITH SOCKET (115 VOLTS — 60 CYCLES)															
32-7583	650	75	5.0	2.0	6.7	2.1					3 ⁷ / ₈	3	3 ⁵ / ₈	2 ⁷ / ₈	10.25
32-7837	650	100	5.0*	2.0	6.7	3.6					4	3 ¹ / ₄	3 ⁷ / ₈	2 ⁵ / ₈ x 3 ¹ / ₈	12.25
32-7688	700	170	5.0	2.0	6.7	4.0	6.7	4.0			3 ⁷ / ₈	3 ¹ / ₈	4 ¹ / ₈	3 ⁷ / ₈	17.00
32-7640	725	140	5.0*	3.0	6.7	4.2					4 ¹ / ₈	4	4 ¹ / ₈	3 ¹ / ₈ x 3 ³ / ₄	13.00
VERTICAL-MOUNTING TYPES (115 VOLTS — 25 CYCLES)															
32-8076	540	52	6.4	2.3							3 ³ / ₈	2 ¹ / ₈	3 ¹ / ₈	2 ¹ / ₈ x 2 ¹ / ₄	5.50
VERTICAL-MOUNTING TYPES, UNCASED (115 VOLTS — 25 CYCLES)															
32-8210	510	50	6.4	3.5							3 ³ / ₈	2	2 ¹ / ₂	2 ¹ / ₈ x 2 ¹ / ₈	8.50
HORIZONTAL-MOUNTING TYPES (115 VOLTS — 25 CYCLES)															
32-7975	525	50	6.4	2.3							3 ¹ / ₂	2 ¹ / ₂	3	2 ¹ / ₈ x 2 ¹ / ₂	7.25
32-8195	525	75	6.4	4.3							4 ¹ / ₈	2 ¹ / ₂	3	2 ¹ / ₄	9.25
32-8031	650	100	5.0	2.0	6.3	3.6					4 ⁷ / ₈	3 ¹ / ₄	3 ⁷ / ₈	2 ⁵ / ₈ x 3 ¹ / ₈	13.50
32-8214	675	100	5.0	2.0	6.4	4.35					4 ¹ / ₈	3 ¹ / ₄	3 ⁷ / ₈	2 ⁵ / ₈ x 3 ¹ / ₈	14.00
VERTICAL-MOUNTING TYPES (115 TO 230 VOLTS — 60 CYCLES)															
32-8269	560	75	6.4	2.5							3 ¹ / ₄	3	2 ⁵ / ₈	2 x 2 ¹ / ₈	10.00
VERTICAL-MOUNTING TYPES, UNCASED (115 TO 230 VOLTS — 60 CYCLES)															
32-8271	510	50	6.4	2.4							3 ³ / ₈	2 ¹ / ₂	2 ¹ / ₈	1 ¹ / ₈ x 2 ¹ / ₈	6.25
HORIZONTAL-MOUNTING TYPES (115 TO 230 VOLTS — 60 CYCLES)															
32-8005	525	50	6.3	2.3							2 ⁷ / ₈	2 ¹ / ₂	3		3.75
32-8109	640	100	5.0	2.0	6.3	3.6					3 ¹ / ₈	3 ¹ / ₄	3 ⁷ / ₈		6.00
HORIZONTAL-MOUNTING TYPES, WITH SOCKET (115 TO 230 VOLTS — 60 CYCLES)															
32-8006	525	50	6.3	2.3							3 ¹ / ₈	2 ¹ / ₂	3	2 ¹ / ₄	6.60
VIBRATOR POWER TRANSFORMERS															
VERTICAL-MOUNTING TYPES															
65-0404	225	60									2 ¹ / ₈	2 ³ / ₄	1 ⁷ / ₈	2 ³ / ₈	4.25
65-0464	250	40									2 ¹ / ₈	1 ⁷ / ₈	2	1 ¹ / ₈	2.25
32-7352	265	40									3 ³ / ₈	2 ¹ / ₂	2 ³ / ₈	2 ¹ / ₄ x 1 ³ / ₄	5.25
VERTICAL-MOUNTING TYPES, UNCASED															
32-7504	130	25									3 ³ / ₈	2 ³ / ₈	2 ¹ / ₂	1 ³ / ₄ x 2 ¹ / ₈	2.75
65-0016	225	60									2 ⁷ / ₈	3	2 ¹ / ₈	1 ⁷ / ₈ x 1 ⁷ / ₈	7.00
65-0358	235	70									2 ¹ / ₈	2 ¹ / ₈	3 ³ / ₈	2 ¹ / ₂	4.00
65-0455	260	60									2 ¹ / ₈	2 ¹ / ₈	2 ³ / ₈	1 ³ / ₄	3.75
65-0234	275	50									2 ¹ / ₂	2 ¹ / ₈	2 ¹ / ₈	2 x 1 ³ / ₈	5.25
32-8314	335	70									2 ¹ / ₂	2 ¹ / ₈	2 ¹ / ₈	1 ⁵ / ₈ x 2	4.25
HORIZONTAL-MOUNTING TYPES															
32-8128	225	60									2	1 ³ / ₄	2 ¹ / ₈	2 ³ / ₄	2.90
32-8313	335	70									2 ¹ / ₈	2 ¹ / ₈	2 ³ / ₈	1 ³ / ₄	5.10



PHILCO MASTER POWER TRANSFORMERS

Philco master power transformers replace many specific types of transformers used in Philco radios. The table below lists in bold-face print the master transformer, and, indented underneath it, the units it can replace.

H — horizontal mounting
 V — vertical mounting
 U — unshielded
 S — socket on transformer
 * Denotes center tap.

115 VOLTS — 60 CYCLES

PART NO.	PRIMARY		SECONDARY		RECTIFIER	FIL. NO. 1	FIL. NO. 2	FIL. NO. 3	DIMENSIONS IN INCHES			MTG. TYPE	MTG. CNTRS. IN INCHES	LIST PRICE				
	VOLTS	FREQ.	A.C. VOLTS	D.C. M.A.					VOLTS AMP.	VOLTS AMP.	VOLTS AMP.				H	L	W	
32-8221	120	60	525	75	6.4	4.0	6.4*	0.3	3 $\frac{3}{8}$	2 $\frac{1}{2}$	3	H	2 $\frac{1}{4}$	* \$7.50				
32-8177	120	60	525	75	6.4	4.3			3 $\frac{3}{8}$	2 $\frac{1}{2}$	3	H	2 $\frac{1}{4}$					
32-8187	120	60	525	75	6.4	4.3			3 $\frac{3}{8}$	2 $\frac{1}{2}$	3	H	2 $\frac{1}{4}$					
32-8122	120	60	525	65	6.4	3.0			3 $\frac{3}{8}$	2 $\frac{1}{2}$	3	H	2 $\frac{1}{4}$					
32-8222	120	60	525	75	6.4	4.0	6.4*	0.3	3 $\frac{3}{8}$	2 $\frac{1}{2}$	3	H	2 $\frac{1}{4}$					
32-8065	115	60	525	65	6.4	2.8			3 $\frac{1}{2}$	2 $\frac{1}{2}$	3	H	2 $\frac{1}{4}$					
32-8052	115	60	525	65	6.4	2.8			3 $\frac{1}{2}$	2 $\frac{1}{2}$	3	H	2 $\frac{1}{4}$					
32-8055	115	60	524	52	6.4	2.3			3	2 $\frac{3}{8}$	3 $\frac{3}{8}$	V	2 $\frac{1}{4}$ x1 $\frac{1}{8}$					
32-8121	120	60	525	65	6.4	3.0			3 $\frac{1}{8}$	2 $\frac{1}{2}$	3	H	2 $\frac{1}{4}$					
32-8166	115	60	560	65	6.4	3.3	6.4*	0.15	3	2 $\frac{1}{2}$	3	H	2 $\frac{1}{4}$	8.00				
32-7977	115	60	580	48	6.4	2.3			2 $\frac{3}{8}$	3	3 $\frac{3}{8}$	H	2 $\frac{1}{8}$					
32-8132	115	60	565	65	6.4	2.85	6.4*	0.15	3	2 $\frac{5}{8}$	2 $\frac{3}{4}$	V	2 $\frac{1}{4}$ x1 $\frac{5}{8}$					
32-8239	117	50/60	560	65	6.4	3.3			3 $\frac{1}{8}$	2 $\frac{3}{8}$	2 $\frac{7}{8}$	V	1 $\frac{3}{8}$ x2 $\frac{1}{4}$					
32-8234	117	50/60	560	65	6.4	3.3			3 $\frac{3}{8}$	2 $\frac{1}{2}$	2 $\frac{7}{8}$	VU	1 $\frac{7}{8}$ x2 $\frac{1}{8}$					
32-8223	115	60	640	90	6.3	4.2	6.3*	0.3	3 $\frac{1}{2}$	3	3 $\frac{1}{8}$	H	2 $\frac{1}{2}$ x3 $\frac{1}{8}$	9.50				
32-8192	115	60	640	90	6.3	4.5			3 $\frac{1}{2}$	3	3 $\frac{1}{8}$	H	2 $\frac{1}{2}$ x3 $\frac{1}{8}$					
32-8243	117	60	640	85	6.4	3.45	6.4*	0.3	3 $\frac{3}{8}$	2 $\frac{1}{2}$	4	V	2 $\frac{1}{8}$ x2 $\frac{1}{4}$					
32-7381	115	60	680	65	5.0	2.0	6.3*	2.2	3 $\frac{3}{8}$	3	3 $\frac{3}{8}$	H	2 $\frac{1}{2}$ x3 $\frac{1}{8}$	8.25				
32-7137	115	60	680	65	5.0	2.0	6.3*	2.2	4 $\frac{1}{2}$	3 $\frac{3}{8}$	3	V	2 $\frac{1}{2}$ x2 $\frac{1}{4}$					
8046	115	60	680	65	5.0	2.0	6.3*	2.2	4 $\frac{1}{2}$	3 $\frac{3}{8}$	3	V	2 $\frac{1}{2}$ x2 $\frac{1}{4}$					
32-7111	115	60	760	140	5.0	2.0	6.3*	3.75	5 $\frac{3}{8}$	4	3 $\frac{3}{4}$	V	3 $\frac{1}{8}$ x3 $\frac{1}{8}$	11.00				
32-7402	115	60	760	140	5.0	2.0	6.3	3.75	4	4	4 $\frac{1}{2}$	H	3 $\frac{1}{8}$ x3 $\frac{3}{4}$					
32-7283	115	60	780	150	5.0	3.0	6.3*	5.0	4 $\frac{1}{4}$	4	4 $\frac{1}{2}$	H	3 $\frac{1}{8}$ x3 $\frac{3}{4}$					
32-7258	115	60	780	150	5.0	3.0	6.3	5.0	5 $\frac{3}{8}$	4	4	V	3 $\frac{1}{8}$ x3 $\frac{3}{8}$					
32-8001	115	60	750	125	5.0	2.0	6.4	4.85	3 $\frac{1}{2}$	4	4 $\frac{1}{2}$	H	3 $\frac{1}{2}$ x3 $\frac{3}{4}$					
32-7552	115	60	580	50	5.0	2.0	6.3*	1.5	2 $\frac{1}{2}$	2 $\frac{1}{2}$	3	H	2 $\frac{1}{8}$ x1 $\frac{1}{4}$	5.75				
32-7064	115	60	580	50	5.0	2.0	6.3*	1.5	2 $\frac{1}{8}$	2 $\frac{1}{8}$	3	H	2 $\frac{1}{2}$ x2 $\frac{1}{2}$					
32-7780	115	60	574	50	5.0	2.0	6.3	1.5	2 $\frac{1}{2}$	2 $\frac{1}{2}$	3	H	2 $\frac{1}{8}$ x1 $\frac{1}{4}$					
32-8226	115	60	650	110	5.0	2.0	6.4	3.7	3 $\frac{1}{2}$	3 $\frac{1}{4}$	3 $\frac{3}{8}$	H	2 $\frac{3}{8}$ x3 $\frac{1}{8}$	8.25				
32-8204	115	60	650	110	5.0	2.0	6.4	4.0	3 $\frac{1}{2}$	3 $\frac{1}{4}$	3 $\frac{3}{8}$	H	2 $\frac{3}{8}$ x3 $\frac{1}{8}$					
32-8186	115	60	750	150	5.0	2.0	6.4	5.2	6.4*	0.15	2.5	2.5	4	4	4 $\frac{1}{2}$	H	3 $\frac{1}{8}$ x3 $\frac{3}{4}$	18.00
32-8137	115	60	800	135	5.0	2.0	6.4	5.2	6.4*	0.15	2.5	2.5	4	4	4 $\frac{1}{2}$	H	3 $\frac{1}{8}$ x3 $\frac{3}{4}$	
32-8140	115	60	800	135	5.0	2.0	6.4	5.2			2.5	2.5	4	4	4 $\frac{1}{2}$	H	3 $\frac{1}{8}$ x3 $\frac{3}{4}$	
32-8220	115	60	512	50	6.4	3.2	6.4*	0.3	3 $\frac{1}{8}$	2 $\frac{1}{2}$	2 $\frac{1}{8}$	VU	2 $\frac{1}{8}$ x1 $\frac{3}{8}$	7.00				
32-8064	115	60	530	50	6.4	2.4			3 $\frac{1}{8}$	2 $\frac{1}{2}$	2 $\frac{1}{8}$	VU	2 $\frac{1}{8}$ x1 $\frac{3}{8}$					
32-8183	115	60	512	50	6.4	3.5			3 $\frac{1}{8}$	2 $\frac{1}{2}$	2 $\frac{1}{4}$	VU	2 $\frac{1}{8}$ x1 $\frac{3}{8}$					
6072	115	60	660	120	5.0	2.0	2.5*	12.25	2.5*	3.45					14.75			
5117	115	60	665	95	5.0	2.0	2.5	9.2	2.5*	1.5								
4813	115	60	700	110	5.0	2.0	2.5	7.45	2.5*	3.0								
5594	125	60	725	120	5.0	2.0	2.68*	3.45	2.67*	14.0					17.50			
3752	115	60	725	110	5.0	2.0	2.68*	3.45	2.67*	10.5								
32-7180	115	60	630	55	5.0	2.0	6.3	1.5							8.50			
7421	115	60	630	55	5.0	2.0	6.3	1.5										



PHILCO MASTER POWER TRANSFORMERS (Cont.)

PART NO.	PRIMARY		SECONDARY		RECTIFIER	FIL No. 1	FIL No. 2	FIL No. 3	DIMENSIONS IN INCHES			MTG. TYPE	MTG. CNTRS. IN INCHES	LIST PRICE
	VOLTS	FREQ.	A.C. VOLTS	D.C. M.A.					VOLTS AMP.	VOLTS AMP.	VOLTS AMP.			
115 VOLTS — 25 CYCLES														
32-8195	120	25	525	75	6.4	4.3			4 1/4	2 1/2	3	H	2 1/4	9.25
32-8074	115	25	525	65	6.4	2.8			4 1/4	2 1/2	3	H	2 1/4	
32-8086	115	25	525	65	6.4	2.8			4 1/4	2 1/2	3	H	2 1/4	
32-8150	115	25	525	65	6.4	3.0			4 1/4	2 1/2	3	H	2 1/4	
32-8147	120	25	525	65	6.4	3.0			4 1/4	2 1/2	3	H	2 1/4	
32-8076	115	25	540	52	6.4	2.3			3 3/4	2 3/4	3 1/4	V	2 1/4 x 2 1/4	5.50
32-7867	120	25	546	45	6.7	2.0			3 1/4	2 3/4	3 1/4	V	2 3/8 x 2	
32-8214	115	25	680	106	5.0	2.0	6.4	4.35	4 1/4	3 1/4	3 7/8	H	2 3/8 x 3 1/4	14.00
32-7627	120	25	680	70	5.0	2.0	6.7	2.1	3 3/4	3 1/4	3 7/8	H	2 3/8 x 3 1/4	
32-8151	115	25	680	106	5.0	2.0	6.4	4.35	4 1/4	3 1/4	3 7/8	H	2 3/8 x 3 1/4	
32-7382	120	25/40	680	65	5.0	2.0	6.4	4.1	4 1/4	3 1/4	3 7/8	H	2 3/8 x 3 1/4	
32-8080	115	25	680	100	5.0	2.0	6.3	2.2	3 3/4	3 1/4	3 7/8	H	2 3/8 x 3 1/4	
32-8031	115	25	640	100	5.0	2.0	6.3	3.6	4 3/8	3 1/4	3 7/8	H	2 3/8 x 3 1/4	13.50
32-8205	120	25	640	85	5.0	2.0	6.3	2.5	3 1/2	3 1/4	3 7/8	H	2 3/8 x 3 1/4	
32-7975	120	25	524	48	6.4	2.3			3 1/2	2 1/2	3	H	2 1/4 x 2 1/2	7.25
32-8075	115	25	512	50	6.4	2.4			3 3/4	2 1/2	3	VU	2 1/8 x 2 3/4	
32-8149	115	25	525	45	6.4	2.7			3 3/4	2 3/4	3 3/8	V	1 1/4 x 2 1/4	
32-8014	120	25/40	524	48	6.4	2.3			3 3/4	2 1/2	3	H	2 1/4 x 2 1/2	
32-8030	120	25	526	48	6.3	2.3			3 7/8	2 1/2	3	H	2 1/4 x 2 1/2	
115/230 VOLTS — 60 CYCLES														
32-8005	115/230	60	524	48	6.3	2.3			2 7/8	2 1/2	3	H	2 1/4	3.75
32-8108	115/230	60	526	48	6.3	2.3			2 1/4	2 1/2	3	H	2 1/4	
32-8109	115/230	50/60	640	100	5.0	2.0	6.3	3.6	3 3/4	3 1/4	3 7/8	H	2 3/8 x 3 1/4	6.00
32-8178	115/230	50/60	600	85	5.0	2.0	6.3	2.5	3 3/4	3 1/4	3 7/8	H	2 3/8 x 3 1/4	
115 VOLTS — 60 CYCLES, HORIZONTAL WITH SOCKETS														
32-7837	115	60	660	100	5.0*	2.0	6.7	3.6	4	3 1/4	3 7/8	H&S	2 5/8 x 3 1/4	12.25
32-7597	120	60	670	100	5.0*	2.0	6.7	3.0	4 1/8	3 1/4	3 7/8	H&S	2 5/8 x 3 1/4	
32-7640	115	60	720	140	5.0*	3.0	6.7	4.2	4 3/4	4	4 1/4	H&S	3 1/2 x 3 3/4	13.00
32-7606	115	60	700	135	5.0*	2.0	6.7	3.3	4 3/4	4	4 1/4	H&S	3 1/2 x 3 3/4	
32-7853	115	60	712	135	5.0*	2.0	6.7	3.3	4 3/4	4	4 1/4	H&S	3 1/2 x 3 3/4	
32-7699	115	60	740	175	5.0*	3.0	6.7	6.5	5 3/4	4	4 1/4	H&S	3 1/2 x 3 3/4	15.50
32-7615	115	60	735	168	5.0*	3.0	6.7	3.6	4 3/4	4	4 1/4	H&S	3 1/2 x 3 3/4	
PHILCO MASTER VIBRATOR POWER TRANSFORMERS														
65-0404			223	60					2 1/4	2 3/4	1 7/8	V	2 3/8	4.25
65-0185			223	60					2 1/4	2 3/4	1 7/8	V	2 3/8	
65-0260			223	60					2 1/4	2 3/4	1 7/8	V	2 3/8	
32-7352			263	40					3 3/4	2 1/2	2 3/4	V	2 1/4 x 1 3/4	5.25
32-7482			263	40					3 3/4	2 1/2	2 3/4	V	2 1/8 x 1 3/4	
32-7488			263	40					3 3/4	2 1/2	2 3/4	V	2 1/2 x 1 3/4	
32-7216			263	40					3 3/4	2 1/2	2 1/4	V	2 1/8 x 1 1/4	
32-7232			263	40					3 1/2	2 1/2	2 1/4	V	2 1/4	
65-0016			223	60					2 7/8	3	2 1/4	VU	1 3/8 x 1 7/8	7.00
65-0033			223	60					2 7/8	3	2 1/4	VU	1 3/8 x 1 7/8	
65-0234			275	50					2 1/2	2 1/4	2 1/4	V	1 3/8 x 2	5.25
65-0318			275	50					2 1/2	2 1/4	2 1/4	V	1 3/8 x 2	



PHILCO UNIVERSAL FILTER CHOKES

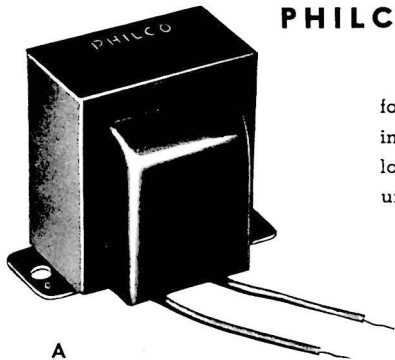

A

The insulating paper is heat-treated for protection against cracking when warm, and the winding itself has been tested with current ten times the rated value.

Philco universal filter chokes are ideal for replacement or original use. Housed in drawn-steel, bracket-type frames, with locked joints for hum-free operation, Philco universal filter chokes feature:

- Vacuum impregnation
- Double-enamelled wire
- Anchor-sealed leads
- High-voltage insulation
- Oversized cores

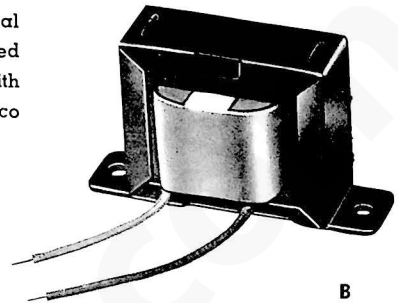

B

The correct Philco universal filter choke for your needs can be determined from the chart below. These units cover almost any choke replacement.

PART NUMBER	FIG.	INDUCTANCE IN HENRIES	D.C. MILS	RESISTANCE IN OHMS	HEIGHT IN INCHES	CORE WIDTH IN INCHES	COIL WIDTH IN INCHES	MTG. HOLES IN INCHES	LIST PRICE
65-0150	B	4	40	140	1 13/32	1 23/32	1 5/16	2 1/16	\$1.75
32-7036	A	4	60	185	2	1 21/32	1 11/16	2 1/8	2.00
32-8182	B	7	40	375	1 13/32	1 23/32	1 3/8	2 1/16	2.00
32-7543	B	7	50	150	2 11/32	2	1 3/4	2 3/8	2.50
32-7491	B	7.5	50	400	2	1 21/32	1 3/8	2 1/8	2.50
32-7213	A	17	60	400	2 13/32	2	2 3/16	2 3/8	3.00
32-7528	A	65	10	2250	2	1 21/32	1 11/16	2 1/8	2.75

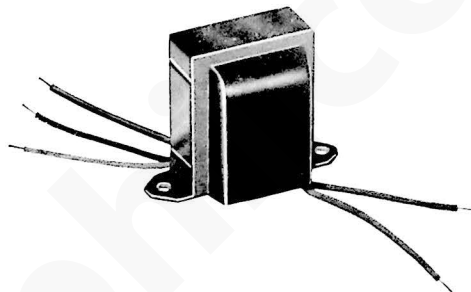

PHILCO INPUT TRANSFORMERS

Philco input transformers are engineered to exacting standards, to assure excellent performance and long life. They are constructed with high-voltage insulation, and are fully impregnated against moisture. The frequency response of these transformers recommends them for use in audio circuits where fine tone quality is important.

Data for determining the proper Philco input transformer may be obtained from the list below.

● OVERSIZED CORES

● COLOR-CODED LEADS

PART NUMBER	DRIVER	OUTPUT	TURNS RATIO	MTG. HOLES IN INCHES	HEIGHT IN INCHES	CORE WIDTH IN INCHES	COIL WIDTH IN INCHES	LIST PRICE
32-7484	76	2-43	1:1	2 3/8	2 5/16	2	1 7/8	\$4.35
32-7828	85	2-41	1:4	2 3/8	2 1 1/32	2	1 3/4	5.50
4862	17	2-71A	1:4	2 3/8	2 7/16	2	1 3/4	5.50
32-7471	85	2-42	1:4	2 3/8	2 1 3/32	2	2 1/8	6.00
32-7865	6J5	2-6L6	1.2:1	2 3/8	2 1 3/32	2	1 7/8	6.00
65-0097	7A4	6Y7	2.5:1	2 3/8	2 1 1/32	2	1 3/4	4.00

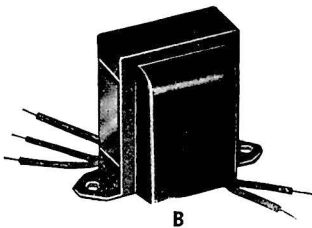
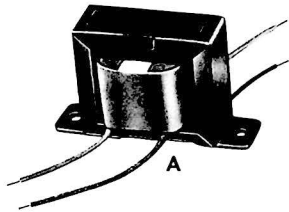

OUTPUT TRANSFORMERS

Philco output transformers are designed for properly matching output tubes to speakers.

Wound with the finest-quality copper wire for dependability and uniform electrical characteristics, Philco output transformers use a special iron laminated core for efficient magnetic conduction, and high-grade insulation tested at 900 volts. The coils and core are vacuum-dried to produce a truly rust-resistant and low-loss transformer. The leads are color-coded and sealed at the junctions with acid-free tapes.

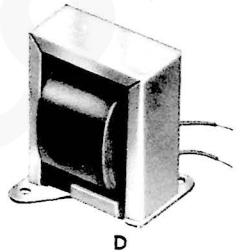
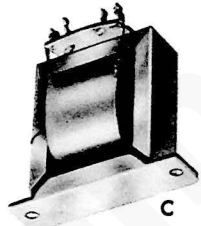

PART NUMBER	PRIMARY IMP. IN OHMS	SECONDARY IMP. IN OHMS	WATTS	TURNS RATIO	FIG.	MOUNTING HOLES IN INCHES	LIST PRICE
SINGLE TYPE							
32-7566	3,000	0.89	6	69	B	2 1/8	1.90
32-7567	6,200	0.89	6	86	A	2 1/8	2.50
32-7065	6,900	1.11	10	76	C	2 7/8	3.50
32-7562	10,000	1.11	10	93	C	2 3/8	3.75
32-8296-5	2,000	3.5	3	75	A	2 1/16	1.85
32-8242	4,500	3	6	39	B	2 1/2	2.50
65-0454	5,200	3	42	A	2 1/8	1.25
65-0162	10,000	3	3	58	A	2 1/16	2.60
32-8100	25,000	3	4	90	A	2 1/16	2.50
32-8116	8,000	3.5	3	44	A	2 1/16	2.25
32-7978	6,000	5	6	35	A	2 1/2	2.50
32-8066	25,000	5.5	6	66	D	1 1/4	1.60
PUSH-PULL TYPE							
32-7286	12,000	0.89	10	114	A	2 3/8	3.50
32-7078	5,580	1.11	10	69	C	2 7/8	3.50
65-0354	10,000	3	10	55	D	1 1/2	4.25
32-7461	2,920	3.42	13	29	B	2 7/8	5.50
32-7905	6,000	3.7	13	37	C	2 7/8	4.50
32-7928	16,500	4.6	6	62/94	C	2 1/2	3.75
32-8250	12,000	5	10	49	B	2 7/8	2.25
32-8028	4,000	3.1	10	36	A	2 7/8	3.75
32-8133	17,000	5	6	58	A	2 1/2	2.25



REFRIGERATOR AND FREEZER CONVERSION TRANSFORMERS

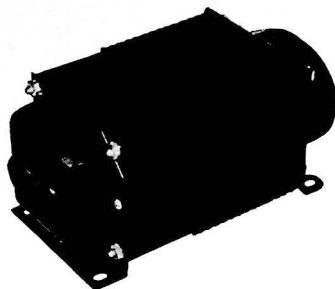

Philco refrigerators and freezers are made as standard units to operate on 115 volts, 60 cycles. Conversion for operation on other voltage and frequency ranges is quickly and easily accomplished by the use of the Philco autotransformers listed below.

The two autotransformer kits listed below contain autotransformer 8040-9 and the proper mounting hardware for Philco freezers, or the A, B, and C lines of Philco refrigerators.

The two autotransformers, 8675-10 and 8675-11, are not supplied with hardware. Mounting hardware of 8040-19 or mounting hardware of 8040-54 must be ordered separately for mounting these units on Philco freezers or Philco A, B, and C line refrigerators.

Complete instructions are supplied with the autotransformer kits.

PART NO.	ITEM	TRANSFORMER TYPE	FOR A. C. SUPPLY	LIST PRICE
8040-19	Autotransformer Kit for Philco Freezers	Single-ratio	115 to 130 volts, 50 cycles	\$15.00
8040-54	Autotransformer Kit for Philco Refrigerators	Single-ratio	115 to 130 volts, 50 cycles	13.50
8675-10	Autotransformer	Multi-tap	200 to 270 volts, 50 or 60 cycles	18.00
8675-11	Autotransformer	Dual-ratio	105 to 130 volts, 50 or 60 cycles	16.00

Philco Step-Down Transformers

The Philco step-down transformers are sturdy power units designed for the conversion of 234-volt, 50-60 cycle supplies to 117 volts, to enable the use of equipment designed for such operation.

These units consist of autotransformers with black-enameled shielding cases. The primary line cord is rubber-covered cable, 8 feet in length. The secondary terminates in a standard 2-prong power socket, mounted on the top of the case. Free from hum at full load. Insulation tested at 900 volts peak.

150 WATT

Current drain at no load: 100 ma.
Dimensions: 4³/₁₀" x 4²/₅" x 3¹/₂"

PART NO.
32-8285

LIST PRICE
\$8.45

75 WATT

Current drain at no load: 100 ma.
Dimensions: 3¹/₂" x 3¹/₂" x 2¹³/₁₆"

PART NO.
32-8284

LIST PRICE
\$8.75

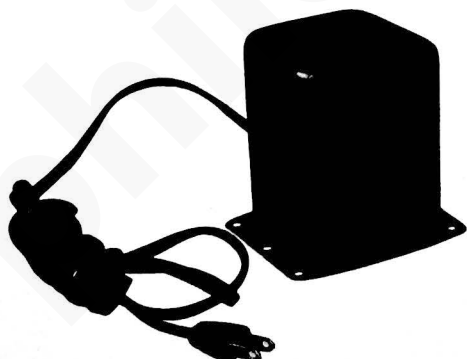

PART NUMBER SYSTEM FOR STANDARD-TYPE FIXED MICA AND CERAMIC DIELECTRIC CONDENSERS

STANDARD-TYPE FIXED MICA DIELECTRIC CONDENSERS

Part Number

The part number consists of a prefix 60- and a suffix of eight digits. For example: 60-90505007. To aid in explaining the numbering system, the number is separated into four groups, each of which is identified by a letter, as follows:

60- 0000 0 000
a b c d

a. Prefix 60- designates a standard-type fixed mica-dielectric condenser.

b. In the suffix, the first four digits represent the capacitance value in mmf.; the third and fourth digits are the first and second significant figures, respectively. For values of 10 mmf. or greater, the first digit (up to 6) designates the number of zeroes following the first two significant figures. For values under 10 mmf., the first digit is either 9 or 8, and designates one or two decimal places, respectively, to the left of the last significant figure. The second digit is not used, and remains "0."

c. The fifth digit designates the direct-current working voltage as follows:

NUMBER	D-C VOLTS
3	300
4	*2500
5	500
6	*600
8	*1200

* Voltage stamped on condenser.

d. The sixth, seventh, and eighth digits represent characteristics of special interest to engineers; this information may be obtained from the Philco Corporation Standards.

STANDARD-TYPE FIXED CERAMIC DIELECTRIC CONDENSERS

Part Number

The part number consists of a prefix 62- and a suffix of nine digits. For example: 62-980409001. To aid in explaining the numbering system, the number is separated into four groups, each of which is identified by a letter, as follows:

62- 000 0 00000
a b c d

a. Prefix 62- designates a standard type fixed ceramic-condenser.

b. In the suffix, the first three digits represent the capacitance value in mmf.; the second and third digits are the first and second significant figures, respectively. For values of 10 mmf. or greater, the first digit (up to 6) of the suffix designates the number of zeroes following the first two significant figures. For values under 10 mmf., the first digit is either 9 or 8, and designates one or two decimal places, respectively, to the left of the last significant figure.

c. The fourth digit designates the capacitance tolerance, as follows:

NUMBER	TOLERANCE	
	ABOVE 10 MMF.	10 MMF. & BELOW
0	±20%	±2.0 mmf.
2	±2%	
3	±5%	±0.5 mmf.
4	±10%	±1.0 mmf.

d. The sixth, seventh, eighth, and ninth digits represent characteristics of special interest to engineers; this information may be obtained from the Philco Corporation Standards.

Special-type fixed-dielectric condensers have part numbers which do not conform to the above system.



PHILCO PAPER CONDENSERS

Philco paper condensers are made of the finest-quality foil and laminated paper, and are tested at double the rated voltage, to insure accurate capacitance ratings and protection against dielectric breakdown. In conjunction with the wax coating, for protection against moisture, these features make the Philco paper condenser the perfect all-round unit for its recommended applications.

● OIL-IMPREGNATED

● NON-INDUCTIVE

● 2¼-INCH LEADS

PART NO.	CAP. IN MFD.	DIMENSIONS IN INCHES		LIST PRICE	PART NO.	CAP. IN MFD.	DIMENSIONS IN INCHES		LIST PRICE
		D.	L.				D.	L.	
1500 WORKING VOLTS D.C.					600 WORKING VOLTS D.C. (cont.)				
45-3500-16	.001	3/8	1 3/8	\$0.55	61-0179	.004	3/8	1 1/4	.25
61-0130	.002	7/16	1 3/8	.55	45-3502	.005	3/8	1 1/4	.25
61-0115	.003	1/2	1 1/2	.55	45-3500-7	.006	3/8	1 1/4	.25
45-3500-17	.004	9/16	1 1/2	.55	61-0174	.008	3/8	1 1/4	.30
61-0153	.005	9/16	1 3/8	.55	61-0120	.01	7/16	1 1/4	.25
45-3500-18	.006	9/16	1 3/8	.55	61-0108	.02	7/16	1 3/8	.25
61-0127	.007	5/8	1 3/8	.55	61-0119	.03	1/2	1 3/8	.30
45-3500-21	.01	5/8	2 1/8	.60	45-3500	.04	1/2	1 3/8	.35
1000 WORKING VOLTS D.C.					61-0170	.05	9/16	1 3/8	.30
45-3500-11	.001	3/8	1 3/8	.50	45-3501	.07	1 1/16	1 3/8	.35
61-0117	.003	7/16	1 3/8	.50	45-3500-8	.1	5/8	2	.35
61-0129	.004	7/16	1 3/8	.50	45-3500-9	.25	1 3/16	2 1/2	.55
45-3500-12	.005	7/16	1 3/8	.50	45-3500-10	.5	1 1/16	2 1/2	.75
61-0105	.006	7/16	1 3/8	.50	400 WORKING VOLTS D.C.				
45-3500-13	.008	7/16	1 3/8	.50	45-3500-1	.03	7/16	1 1/4	.25
61-0124	.01	1/2	1 3/8	.50	45-3500-2	.04	3/8	1 1/2	.25
61-0138	.015	9/16	2	.50	61-0122	.05	7/16	1 1/2	.25
61-0118	.02	9/16	2	.50	45-3500-19	.07	1/2	1 1/2	.30
61-0126	.03	5/8	2 1/8	.55	61-0113	.1	9/16	1 1/2	.30
45-3500-14	.05	1 3/16	2 1/8	.60	45-3500-3	.2	9/16	2	.35
45-3500-15	.1	1 5/16	2 1/2	.75	61-0125	.25	5/8	2	.35
600 WORKING VOLTS D.C.					45-3500-4	.5	7/8	2	.55
45-3500-5	.001	3/8	1 1/8	.25	200 WORKING VOLTS D.C.				
45-3500-6	.0015	3/8	1 1/8	.25	61-0133	.5	5/8	2	.55
61-0062	.002	3/8	1 1/8	.25	100 WORKING VOLTS D.C.				
61-0109	.003	3/8	1 1/4	.25	61-0152	.07	7/16	1 1/4	.25
					61-0137	.5	7/16	2	.50



MICA CONDENSERS

Philco mica condensers, used in radios all over the world, give years of dependable service. They are sealed against moisture, to insure superior performance under all conditions.

The small size and the molded exterior insulation of these condensers simplify installation in modern complex receivers.

All units are individually tested, and are available in RMA preferred values. All are rated at 500 w. v. d.c., except those marked with an asterisk, which are 300 w. v. d.c.

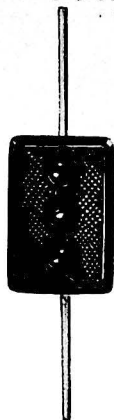

SILVERED-MICA CONDENSERS

Philco silvered-mica condensers are designed for special applications where constant capacitance must be maintained over long periods of time.

The low-loss characteristics of these units make them particularly useful in r-f and i-f circuits, where maximum efficiency of operation is important.

All units are individually tested, and are available in RMA preferred values. All are rated at 300 w. v. d.c., except those marked with an asterisk, which are 500 w. v. d.c.



PART NUMBER	CAP. IN MMFD.	TOLERANCE %	LIST PRICE
60-90505007	5	20	\$0.20
60-00105407	10	10	.35
60-00155407	15	10	.20
60-00185317	18	5	.20
60-00205307	20	5	.20
60-00245307	24	5	.20
60-00305307	30	5	.20
60-00365307	36	5	.20
60-00395407	39	10	.20
60-00515307	51	5	.30
60-00625307	62	5	.20
60-00685407	68	10	.20
60-00825307	82	5	.30
60-10105407	100	10	.20
60-10135307	130	5	.20
60-10155407	150	10	.20
60-10205307	200	5	.20
60-10245307	240	5	.25
60-10275407	270	10	.20
60-10305307	300	5	.25
60-10335407	330	10	.25
60-10395407	390	10	.25
60-10515307	510	5	.35
60-10565314	560	5	.30
60-10625301	620	5	.35
60-10685401	680	10	.25
60-10755301	750	5	.35
60-10825401	820	10	.25
60-10915301	910	5	.35
60-20105401	1000	10	.30
60-20125404	1200	10	.30
60-20155404	1500	10	.35
60-20205304	2000	5	.35
60-20245304	2400	5	.40
60-20275404	2700	10	.40
60-20305304	3000	5	.45
60-20335404	3300	10	.45
60-20395404	3900	10	.50
60-20515304	5100	5	.70
60-20625304	6200	5	.90
60-20823404	8200*	10	.90
60-30103404	10000*	10	1.15

PART NUMBER	CAP. IN MMFD.	TOLERANCE %	LIST PRICE
30-1223	5	20	\$0.50
30-1223-1	10	10	.55
30-1223-2	12	5	.30
30-1223-3	15	5	.50
30-1223-4	20	5	.75
30-1223-5	24	5	.75
30-1223-6	30	5	.75
30-1223-7	36	5	.75
60-00515237	51*	2	.35
60-00605237	60	2	.35
60-00685237	68	2	.35
60-00825237	82	2	.35
60-00915237	91	2	.35
60-10105237	100	2	.35
30-1220	104	1	.50
30-1220-26	115	2	.50
60-10125237	120*	2	.35
30-1220-27	125	2	.35
60-10135237	130*	2	.50
30-1220-20	135	2	.50
30-1220-28	145	2	.50
30-1220-1	150	1	.50
30-1220-29	155	2	.50
30-1220-2	170	1	.50
30-1220-4	185	2	.50
60-10195237	190*	2	.35
60-10205237	200*	2	.35
60-10215237	210*	2	.35
30-1220-4	215	1	.50
30-1220-31	235	2	.50
30-1220-34	245	1	.50
60-10255237	250*	2	.35
30-1220-24	255	1	.75
30-1220-5	265	1	.60
30-1220-7	275	1	.60
30-1220-8	280	2	.60
30-1220-9	285	1	.60
30-1220-10	300	1	.40
30-1220-11	310	1	.45
30-1220-12	320	1	.70
60-10355237	350*	2	.45
30-1220-21	360	1	.70
30-1220-14	370	1	.70
30-1220-37	380	1	.50
30-1220-35	390	1	.50
60-10405237	400*	2	.50
30-1220-32	424	2	.70
30-1220-22	437	1	.70
30-1220-33	447	2	.70
30-1220-23	485	1	.45
30-1220-17	500	2	.70
30-1220-18	525	1	.70
60-20105231	1000*	2	.50



CERAMIC CONDENSERS

Philco ceramic condensers are specially designed to provide extremely close tolerance and small size. Temperature and humidity variations have practically no effect on the capacitance of these units. Their insulation resistance is not less than 5000 megohms at 100v d.c. and 25° C.

Because of their exceptionally small size, excellent insulation, and constant capacitance characteristics, Philco ceramic condensers are widely used in push-button tuning units and test equipment, where both space and stability of operation are of great importance. The dielectric is vacuum "sputter-plated" for excellent uniformity of capacitance.

- SMALL
- STABLE
- STURDY

PART NUMBER	CAP. IN MMFD.	WORKING VOLTS D.C.	TOLERANCE	DIMENSIONS IN INCHES		LIST PRICE
				D.	L.	
30-1224-30	3.3	500	.5 mmfd.	.250	.438	\$0.25
30-1224-5	5	500	.5 mmfd.	.250	.562	.30
30-1224-9	6	500	.25 mmfd.	.250	.562	.50
30-1224-6	6.5	500	.3 mmfd.	.250	.562	.50
30-1224-8	7.5	500	.5 mmfd.	.250	.562	.50
30-1224-13	8	500	1 mmfd.	.250	.562	.25
62-980409001	8	500	1 mmfd.	.250	.562	.30
30-1224-26	10	500	1 mmfd.	.250	.562	.25
62-010009001	10	500	2 mmfd.	.250	.562	.25
62-022009001	22	500	20%	.250	.562	.25
30-1224-4	24	500	10%	.250	.562	.30
30-1224	36	500	10%	.250	.562	.25
30-1224-2	51	500	10%	.250	.562	.25
61-0149	54.5		2.8 mmfd.	.250	.812	.30
62-056409001	56	500	10%	.250	.562	.30
62-110009001	100	500	20%	.250	.562	.25
30-1224-1	100	500	10%	.250	.812	.25
30-1224-18	100	500	10%	.250	.562	.30
30-1224-24	200	500	2%	.290	.920	.50
62-122001001	220	300	20%	.250	.562	.25
30-1224-20	220	500	1%	.438	1.650	1.25
30-1224-14	285	500	1%	.438	1.650	1.25
62-133001001	330	300	20%	.250	.562	.35
62-147001001	470	300	20%	.250	.562	.35
30-1224-15	485	500	1%	.438	2.188	1.00
30-1225-5	750	300	20%	.250	.812	.35
30-1225	1000	300	20%	.250	.690	.40
62-215001011	1500	300	20%	.250	.812	.30
30-1225-1	1500	300	20%	.250	.690	.40
30-1225-6	2000	300	20%	.260	.460	.50

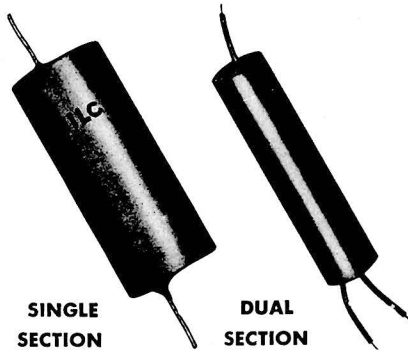

DRY-ELECTROLYTIC CONDENSERS
TUBULAR SELF-MOUNTING TYPE

Philco tubular dry-electrolytic condensers are ideal for a wide variety of service needs. Their etched-plate construction results in maximum capacitance in minimum space.

Special construction techniques provide improved impregnation and high dielectric strength, to insure long life and unsurpassed performance.

- Sealed Against Moisture
- Metal Case, Insulated
- Leak-proof Construction

PART NO.	CAP. IN MFD.	WORKING VOLTS D.C.	DIMENSIONS IN INCHES		LIST PRICE	PART NO.	CAP. IN MFD.	WORKING VOLTS D.C.	DIMENSIONS IN INCHES		LIST PRICE
SINGLE SECTION						DUAL SECTION					
30-2417-7	2	50	9/16	1 1/4	\$1.10	45-3003	8-8	475	1 3/16	2 13/16	1.70
45-3014	4	475	1 1/16	1 13/16	.90	30-2479	10-10	150	7/8	3 7/16	1.15
30-2417	5	50	1 1/16	1 13/16	1.10	30-2521	12-5	300	1 3/16	2 1/2	1.60
45-3018-26	5	150	1 1/16	2 1/2	.70	30-2480	16-8	475	7/8	3 7/8	2.00
45-3002	8	475	1 1/16	2 13/16	.90	30-2547	20-20	150	3/4	2 3/16	1.30
30-2417-3	10	50	1 1/16	1 13/16	1.00	30-2454	20-20	450	1 1/2	3 3/8	2.65
45-3018-27	10	150	9/16	2 1/8	.85	30-2575-12	40-10	250	2 3/32	2 3/8	2.15
30-2417-6	10	450	1 5/16	1 13/16	1.25	30-2510	40-20	200	7/8	2 7/8	2.00
45-3015	12	475	1 3/16	2 5/16	1.15	30-2449	60-40	150	7/8	3 1/2	1.90
30-2559	15	150	1 1/16	2 3/16	.85	30-2575-17	75-10	250	1 1/16	3 3/8	3.65
45-3018-28	15	150	1 3/16	1 13/16	.88						
30-2575-11	15	200	5/8	2 3/8	1.00	PART NO.	CAP. IN MFD.	WORKING VOLTS D.C.	DIMENSIONS IN INCHES		LIST PRICE
45-3018-8	16	250	1 3/16	1 13/16	1.10	MULTIPLE SECTION					
45-3016	16	475	1 3/16	2 5/16	1.35	30-2452	20-10-10	150			\$1.90
45-6265	20	150	5/8	2 1/8	.95	30-2543	20-20-10	150			1.90
45-6249	20	250	5/8	2 1/8	1.20	30-2540-1	30-25-20	150			1.90
45-3004	20	475	1 5/16	2 13/16	1.50	30-2573	30-25-20	150			1.90
45-3001	25	25	1 1/16	1 13/16	.75	30-2575-10	30-25-20	150			2.00
45-3018-30	40	150	1 5/16	2 3/8	1.15	30-2575-2	40-10-10	200			2.25
45-3018-9	40	250	1 5/16	2 5/16	1.45	30-2492	20-10-20-20	150/150/150/25			2.25
30-2520	40	350	7/8	3 1/4	1.75	30-2560	30-10-30-30	150/150/25/150			2.75
45-6252	40	450	1	3 1/8	2.00	30-2506	40-20-10-20	200/200/200/25			2.75
30-2417-2	50	25	1 3/16	1 13/16	.95	30-2498	30-20-10-200-50	150/150/150/25/25			3.00



DRY-ELECTROLYTIC CONDENSERS TAB-MOUNTING TYPE

Philco dry-electrolytic condensers of the tab-mounting type have fabricated-plate construction, a major development of the past few years. This development results in units having greater capacitance and smaller size.

Philco tab-mounting condensers have positive, permanent identification of internal sections.

MOUNTING PLATES for Tab-Mounting Type Condensers



Part No. 45-6239...\$.05

Bakelite Mounting Plate—for use when condenser is to be insulated from chassis.

Part No. 45-6240...\$.05

Metal Mounting Plate—for use when condenser is to be grounded to chassis.

- HERMETICALLY SEALED
- VACUUM-PROCESS WAX IMPREGNATION
- TINNED LEADS

PART NO.	CAP. IN MFD.	WORKING VOLTS D.C.	DIMENSIONS IN INCHES L.		LIST PRICE	PART NO.	CAP. IN MFD.	WORKING VOLTS D.C.	DIMENSIONS IN INCHES L.		LIST PRICE
SINGLE SECTION						MULTIPLE SECTION					
45-3005	8	475	1½	2	\$1.30	30-2570-14	30-25-20	150	1	2½ ₁₆	2.10
45-3007	12	475	1½	2	1.55	30-2568-10	40-70-40	150	1¼	3½ ₁₆	2.90
30-2568-13	15	200	1¼	2½ ₁₆	1.50	61-0068	10-10-20	200/150/25	1	2	1.80
30-2568	15	400	1¼	2¾ ₁₆	1.55	61-0089	15-10-20	350/350/25	1	2	2.40
30-2465	15	450	1	2½ ₁₆	1.55	30-2468	20-10-5	150	1	3	1.50
30-2568-1	15	450	1¼	2¾ ₁₆	1.75	30-2435	20-20-20	150/150/25	1	2½ ₁₆	1.40
30-2555	20	450	1½	2	1.75	30-2512	50-5-5	300	1	3	2.85
30-2568-8	20	450	1¼	2¾ ₁₆	1.90	30-2570-6	15-10-10	450	1	3½ ₁₆	3.00
30-2568-9	30	475	1¼	3½ ₁₆	2.10	30-2570-15	20-10-10	450	1	3½ ₁₆	2.90
30-2568-11	40	200	1¼	2¾ ₁₆	2.10	30-2570-1	30-15-10	450	1¾	3½ ₁₆	3.50
30-2568-5	40	450	1¼	3¾ ₁₆	2.25	30-2570-16	10-10-40	450/450/50	1	2¾ ₁₆	2.95
30-2511	40	450	1	3	2.25	30-2570-5	50-5-5	450/200/200	1	3½ ₁₆	3.50
30-2568-20	40	450	1¾	2	2.50	30-2570-13	10-10-10	475	1	3½ ₁₆	2.50
DUAL SECTION						30-2570-9	10-10-40	475/475/50	1	3½ ₁₆	3.50
45-3008	8-25	475/25	1¼	2	1.95	30-2570-12	30-20-20	475	1¾	3½ ₁₆	4.00
45-3006	10-10	475	1¾	2	2.10	30-2568-16	50-50-10	150	1¼	2¾ ₁₆	2.50
30-2550	10-25	400	1	2	2.10	61-0150	20-10-5-10	350/350/300/25	1¾	2	3.05
30-2552	10-15	450	1¾	2	2.35	30-2568-12	40-30-20-10	200/200/200/25	1¾ ₆₄	3½ ₁₆	3.25
30-2570	10-25	450	1	3½ ₁₆	2.50	30-2570-10	10-10-10-10	475	1¾	3½ ₁₆	3.25
30-2556	10-25	450	1½	2	2.50	30-2570-8	20-40-10-10	475/475/475/25	1¾	3½ ₁₆	4.00
30-2570-3	10-30	450	1	3½ ₁₆	3.00						
30-2504	10-40	200	1	2½ ₁₆	1.85						
30-2568-14	10-40	250	1¼	2½ ₁₆	1.90						
30-2570-11	25-25	450	1¾	2½ ₁₆	3.00						



- TINNED LEADS
- SEALED AGAINST MOISTURE
- VACUUM-PROCESS WAX IMPREGNATION

**DRY-ELECTROLYTIC CONDENSERS
UNIVERSAL CLAMP-MOUNTING TYPE**

Philco dry-electrolytic condensers of the universal clamp-mounting type are designed as replacements for all dry-electrolytic condensers in any model radio regardless of the year of manufacture. Where the mounting holes are too large, mounting plate 45-S240 may be used as an adapter. Each unit is precision made, and is engineered to withstand the voltage surges encountered in power supplies and similar circuits. The aluminum case provides maximum protection against moisture and physical injury.

PART NO.	CAP. IN MFD.	WORKING VOLTS D.C.	DIMENSIONS D. L.		LIST PRICE	PART NO.	CAP. IN MFD.	WORKING VOLTS D.C.	DIMENSIONS D. L.		LIST PRICE
SINGLE SECTION						DUAL SECTION					
45-3005-2	5	250	1 1/16	3 1/16	\$1.45	45-3005-8	5-5	350	1 1/16	4 1/16	2.25
45-3005-1	5	450	1 1/16	3 1/16	1.50	45-3011	8-8	450	1 1/16	4 1/16	2.40
45-3009	8	450	1 1/16	3 1/16	1.70	45-3005-7	10-5	450	1 1/16	4 1/16	2.40
45-3017-22	12	450	1 1/16	3 1/16	1.75	45-3005-9	10-10	450 50	1 1/16	4 1/16	2.25
45-3005-4	15	200	1 1/16	3 1/16	1.25	45-3017-26	10-10	450	1 1/16	3 1/16	2.70
45-3010	16	450	1 1/16	3 1/16	1.90	45-3012	16-16	450	1 1/16	4 1/16	3.25
45-3017-23	20	450	1 1/16	3 1/16	2.15	45-3005-10	20-10	450 50	1 1/16	4 1/16	2.40
45-3005-5	25	250	1 1/16	3 1/16	1.60	45-3017-30	20-20	450	1 1/16	3 1/16	3.75
45-3017-24	30	450	1 1/16	3 1/16	2.40	45-3017-29	60-40	450	1 1/16	4	4.75
45-3005-6	40	250	1 1/16	3 1/16	1.70	MULTIPLE SECTION					
45-3017-25	40	450	1 1/16	3 1/16	2.80	45-3017-27	10-10-10	450	1 1/16	3 1/16	4.00
						45-3017-28	25-20-20	450	1 1/16	3 1/16	4.50

**DRY-ELECTROLYTIC CONDENSERS
EXACT-REPLACEMENT CLAMP-MOUNTING TYPE**

Philco dry-electrolytic condensers of the exact-replacement clamp-mounting type are recommended where it is desirable to use the built-in clamp of the original installation.

Precision construction and the use of high-quality materials result in the superior performance of these condensers. Identification of each condenser section is clear and positive.

PART NO.	CAP. IN MFD.	WORKING VOLTS D.C.	DIMENSIONS IN INCHES D. L.		LIST PRICE
MULTIPLE SECTION					
30-2073	8-8-10	475/475/50	1 1/8	5 3/4	\$3.25
30-2078	1-1-1-2	450/350/350/300	1 1/8	3 1/4	2.85



- TINNED LUGS
- SEALED AGAINST MOISTURE



IDENTIFY YOURSELF WITH PHILCO SERVICE

Philco has prepared a complete assortment of signs and printed material especially for members of the Philco Service organization. Every Philco owner is told in the instruction sheet to look for the Philco Service emblem in his neighborhood. Your membership in Philco Service and your use of these signs and the printed advertising pieces will establish you as headquarters for reliable service on Philco products. See your Philco Distributor now.

PRINTED SALES HELPS TO INCREASE YOUR SERVICE BUSINESS

And they are completely imprinted with your name, address, city, and phone

LETTERHEADS

Printed on good-quality bond paper in bright yellow-and-blue 8½" x 11" size. Use them for business correspondence and direct-mail advertising.

- PR-1015 Radio Letterhead, Imprinted
- PR-1016 Refrigerator Letterhead, Imprinted

BILL FORMS

Printed on good-quality bond paper in yellow-and-blue, 8½" x 7" size. Can be used for all service groups by all Philco Service members.

- PR-1017 Bill Form, Imprinted

ENVELOPES

Standard 6¼" envelopes suitable for use with letterheads and bill forms. Meets all general mailing requirements. Face carries insignia and your name and return address.

- PR-1018 Envelopes, Imprinted

BUSINESS CARDS

Smart, dignified business cards, yellow and blue on fine-quality card stock. Use them generously to identify yourself and your association with Philco Service.

- PR-1021 Radio Business Card, Imprinted
- PR-1022 Refrigerator Business Card, Imprinted

SERVICE LABELS

Neat labels, 3" x 1", with special adhesive for sticking to metal surfaces, tells customer to call you for quality service. Can be placed on back of radio chassis, cabinet, refrigerator, and air conditioner.

- PR-1535 Service Sticker, Imprinted

RADIO SERVICE HANDBILLS

Attention-getting yellow-and-blue handbills, size 8½" x 5½", with the theme "Looking for Quality Radio Service?" Have them distributed door-to-door and use them as mailing enclosures.

- PR-1545 Radio Service Handbills, Imprinted

RETURN POSTCARD MAILING PIECES

Double postcard with theme—"Looking for Reliable Service?" Convenient return postcard imprinted with your name and address for prospect to mail back to you. A sure-fire medium for getting results in your direct-mail advertising.

- PR-1536 Radio Postcard
- PR-1537 Refrigerator Postcard
- PR-1538 Air Conditioner Postcard

All Imprinted

DIRECT-MAIL INSERTS

Printed on both sides in vivid yellow and blue. Proper size to enclose in standard 6¼" envelope. Enclose these business reminders with your correspondence, invoices, and direct-mail advertising.

- PR-1023-B Radio Mailing
- PR-1024 Refrigerator Mailing
- PR-1025 Special Noise Elimination Mailing

All Imprinted

RADIO BLOTTERS

These colorful blotters are a constant reminder and identify you as a source of expert, reliable, guaranteed service.

- PR-1019 Radio Blotter, Imprinted

MONTHLY CALENDAR BLOTTERS— RADIO SERVICE

A series of twelve handsome mailing or give-away blotters with appropriate seasonal pictures and calendar for each month of the year. Shipped quarterly from factory. Minimum monthly quantity, 100. Imprinted.

- PR-1684 Series of 12 Monthly Calendar Blotters

All Imprinted

NEWSPAPER MATS

Tested copy for advertising both radio and refrigerator service in your local papers. These one and two-column ads will get you new service prospects. Mats obtainable without charge from your Philco Distributor.

ALL OF THESE ITEMS NOW AVAILABLE FROM YOUR PHILCO DISTRIBUTOR

Use Genuine
**PHILCO
PARTS**

SALES AIDS



**OUTDOOR
ILLUMINATED SIGN**



Two-color metal sign, 28½" long by 22" high. Double-weather-proof sockets mounted so that light shines down from reflector hood onto face of sign; can be used singly against wall, or back to back for overhead-bracket mounting.

PART NO. PR-1694
MEMBERS NET PRICE \$7.90

**TELEVISION
SERVICE SIGN**



Outdoor metal sign with wood-frame backing, 2' wide by 4' long, in brilliant yellow and blue enamel.

PART NO. PR-1671
MEMBERS NET PRICE \$4.38

DISPLAY THESE INDOOR SIGNS



Colorful indoor signs silk-screened on heavy composition board in three colors, yellow, blue, and white. Radio sign 15" in diameter. Refrigeration sign 18" wide, 12" high. Suitable for use inside shop or in display window.

PART NO. PR-1027 Indoor Radio Sign \$0.45
PR-1032 Indoor Refrigerator Sign .45

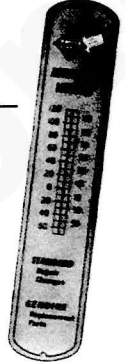

JUMBO THERMOMETER

A Sign with a Dual Purpose

Attracts new attention every day—identifies you with Philco Service. Heavy steel construction, weatherproof, baked-enamel finish in three colors, yellow, blue, and white. Size: 38¾" high, 8" wide.

PART NO. PR-1554
MEMBERS NET PRICE \$3.78

**COUNTER
AND
SHOP
COAT**



Light-tan twill, with Philco Service emblem (silk-embroidered) on pocket. Long-wearing, sanforized material. Sizes: 36, 38, 40, and 42.

PART NO. PR-1549
MEMBERS NET PRICE \$3.60

DECALCOMANIA



Universal type for use indoors or outdoors. Can be attached to inside of window or on outside of car or truck body. Three colors. Weatherproof. Size: 12" x 7¾".

PART NO. PR-1553
MEMBERS NET PRICE \$0.30

**ILLUMINATED
WINDOW SIGN**



Glass face and chromium frame. Finished in three colors to resemble a neon sign when illuminated. Economical to light at night requiring only a 25-watt bulb. A flasher can be used if desired.

PART NO. PR-1033
MEMBERS NET PRICE \$3.00

RUBBER STAMP

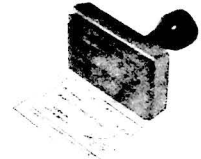

3" wide, 1½" high, with your name, address, city, and telephone. Use it for imprinting special advertising pieces.

PART NO. PR-1408
MEMBERS NET PRICE \$1.50

LAPEL BUTTONS



PART NO. PR-1547
MEMBERS NET PRICE \$0.75

Attractive gold-filled and blue-enamel membership button. Advertise your Philco Service connection by wearing the insignia of the world's largest association of appliance servicemen.



TELEVISION
PART NO. PR-1701
MEMBERS NET PRICE \$0.75



**STANDARD LABOR
CHARGE WALL PLAQUE**

Display your standard radio-service charges as suggested by Philco Service Headquarters. Colorful metal sign, 11-¾" x 15¾", tells customers your whole story on prices, guaranteed labor, and use of genuine replacement parts.

PART NO. PR-1414
MEMBERS NET PRICE \$0.90

**METAL OUTDOOR
FLANGE SIGN**



A durable metal outdoor sign, 18" x 24", in three permanent colors, yellow, blue, and white, printed both sides. Requires no brackets or fixtures. Can be mounted on any solid exterior surface. Gives positive, continuous identification.

PART NO. PR-997
MEMBERS NET PRICE \$2.40

AUTO RADIO SERVICE SIGN



Large outdoor metal sign in standard colors of blue and yellow only for auto radio members of Philco Service. Size: 2' x 6'.

PART NO. PR-1281
MEMBERS NET PRICE \$4.62

ORDER FROM YOUR PHILCO DISTRIBUTOR



PHILCO SERVICE BINDER

Keep your Philco Service manuals in this attractive, sturdy binder. Will expand to 2½" capacity. Convenient to use, easy to operate. Will be a credit to the appearance of your service shop.

PART NO.
PR-1313

MEMBERS
NET PRICE
\$3.72

PHILCO SERVICE MANUALS

Philco Service manuals give you the complete information you need for fast trouble-shooting work. Manuals for all Philco products are currently available from your Philco Distributor.

RADIO AND PHONOGRAPH MANUALS

NO.	MODEL	NO.	MODEL
PR-1439	48-141 and 145	PR-1562	49-503
PR-1434	48-150	PR-1555	49-504
PR-1424	48-2001 and 214	PR-1581	49-505
PR-1447	48-250	PR-1582	49-506
PR-1479	48-300	PR-1518	49-601
PR-1438	48-360	PR-1517	49-602
PR-1435	48-460	PR-1652	49-603
PR-1431	48-461	PR-1583	49-605
PR-1429	48-464	PR-1660	49-607
PR-1426	48-472	PR-1565	49-900
PR-1460	48-475	PR-1580	49-901
PR-1406	48-482	PR-1563	49-902
PR-1511	48-485	PR-1566	49-904
PR-1461	48-1200	PR-1575	49-905
PR-1433	48-1201 and 1260	PR-1568	49-906
PR-1463	48-1253	PR-1564	49-909 and 1101
PR-1432	48-1256	PR-1561	49-1100
PR-1436	48-1262	PR-1516	49-1401
PR-1459	48-1263	PR-1567	49-1405
PR-1462	48-1264	PR-1560	49-1600
PR-1476	48-1266	PR-1559	49-1602 and 1604
PR-1430	48-1270	PR-1558	49-1606
PR-1480	48-1274 and 1276	PR-1586	49-1609 and 1611
PR-1515	48-1284	PR-1587	49-1613
PR-1513	48-1286	PR-1478	M-8
PR-1512	48-1290	PR-1571	M-9
PR-1578	49-100	PR-1599	M-9C
PR-1556	49-500	PR-1584	M-15
PR-1557	49-501	PR-1481	Electromechanical Tuner

PR-329D	Wiring Diagrams, Volume 1, 1928—1936 Models.
PR-329E	Wiring Diagrams, Volume 2, 1937—1938 Models.
PR-762	1939 R.M.S. Yearbook (Wiring Diagrams, 1939 Models).
PR-795	1940 R.M.S. Yearbook (Wiring Diagrams, 1940 Models).
PR-874	1941 R.M.S. Yearbook (Wiring Diagrams, 1941 Models).
PR-930	1942 R.M.S. Yearbook (Wiring Diagrams, 1942 Models).
PR-1522	1946—1947 Philco Service Yearbook (Wiring Diagrams, 1946—1947 Models).

AUTO RADIO MANUALS

NO.	MODEL	NO.	MODEL
PR-1256	UN6-100	PR-1456	P-4735
PR-1257	UN6-400	PR-1251	S-4624
PR-1259	UN6-500	PR-1104	S-4625 (Supp. to PR-1251)
PR-1260	UN6-550	PR-1252	S-4626
PR-1450	CR-2	PR-1302	S-4627 (Supp. to PR-1252)
PR-1452	CR-4 and CR-6	PR-1457	S-4824
PR-1453	CR-8	PR-1508	Control Head Service Bulletin (CR-Line)
PR-1495	CR-9	PR-1096	1931—37 Yearbook
PR-1454	CR-10	PR-1526	1946—47 Yearbook
PR-1455	CR-12		
PR-1253	C-4608		
PR-1491	C-4608, Code 122 (Supp. to PR-1253)		
PR-1254	P-4635		

TELEVISION MANUALS

NO.	SUBJECT
PR-1469	Service Manual for Model 48-700
PR-1468	Installation Instructions for Model 48-700
PR-1445	Installation Instructions for Model 48-1000
PR-1474	Service Manual for Models 48-1000, 48-1000-5, 48-1050, and 48-1050-5 (All Code 122)
PR-1541	Installation Instructions for Model 48-1001
PR-1542	Service Manual for Model 48-1001 (Supp. to PR-1474)
PR-1667	Service Manual for Models 49-1002
PR-1548	Service Manual for Models 49-1075, 1240, and 1275
PR-1444	Service Manual for Model 48-2500
PR-1446	Installation Instructions for Model 48-2500
PR-1451(A)	Television Trouble Shooting by Philco—Lessons 1 and 2
PR-1451(B)	Television Trouble Shooting by Philco—Lessons 3 and 4
PR-1451(C)	Television Trouble Shooting by Philco—Lessons 5 and 6
PR-1451(D)	Television Trouble Shooting by Philco—Lessons 7 and 8
PR-1451(E)	Television Trouble Shooting by Philco—Lessons 9 and 10
PR-1451(F)	Television Trouble Shooting by Philco—Lesson 11
PR-1285	Servicing Television Receivers (General Principles)

REFRIGERATOR AND FREEZER MANUALS

NO.	SUBJECT
PR-940	Consolidated Service Manual and Parts List (Refrigerators through 1942)
PR-996	Servicing Philco Refrigerators (Models K, L, M, R)
PR-1153	Servicing 1946 Philco Refrigerators
PR-1153-S	Servicing 1946 Philco Refrigerators (Spanish)
PR-1282	Servicing 1946 Philco Freezers
PR-1443	Servicing Instructions for Model B-773
PR-1475	Servicing 1948 Philco Refrigerators
PR-1477	Servicing Philco AV-75 Freezers

AIR CONDITIONER MANUALS

NO.	SUBJECT
PR-1320	The Servicing of Single-Room Air Conditioners (1935—1947)
PR-1281	Servicing Philco Air Conditioners (81-C, CL; 76C, CL; 81C)
PR-1506	Servicing Procedures for Models 61D and 61DL
PR-1507	Servicing Procedures for Models 76-D and 76-DL

ORDER FROM YOUR PHILCO DISTRIBUTOR



CARBON RESISTORS — 1/2 WATT

PHILCO carbon resistors are designed to give high quality at low cost.

The strong, molded-bakelite covering, which completely surrounds the rugged resistance element, provides maximum protection against shorts. Permanent anchoring of the leads during the molding process assures noise-free operation.

LIST PRICE

12c
EACH

● COLOR CODED

● SIZE .468" x .170"

● TOLERANCE 10%

PART NUMBER	RESISTANCE IN OHMS	PART NUMBER	RESISTANCE IN OHMS	PART NUMBER	RESISTANCE IN OHMS
66-93033403	66-21833401800	66-4153340150,000
66-94733404.7	66-22033402000	66-4183340180,000
66-010334010	66-22233402200	66-4203340200,000
66-012334012	66-22533402500	66-4223340220,000
66-015334015	66-22733402700	66-4253340250,000
66-018334018	66-23033403000	66-4273340270,000
66-020334020	66-23333403300	66-4303340300,000
66-022334022	66-23533403500	66-4333340330,000
66-025334025	66-23933403900	66-4353340350,000
66-027334027	66-24033404000	66-4393340390,000
66-030334030	66-24733404700	66-4403340400,000
66-033334033	66-25033405000	66-4473340470,000
66-039334039	66-25633405600	66-4503340500,000
66-040334040	66-26033406000	66-4563340560,000
66-047334047	66-26533406500	66-4603340600,000
66-050334050	66-26833406800	66-4683340680,000
66-056334056	66-27033407000	66-4703340700,000
66-068334068	66-27533407500	66-4753340750,000
66-075334075	66-28033408000	66-4803340800,000
66-082334082	66-28233408200	66-4823340820,000
66-1103340100	66-29033409000	66-4903340900,000
66-1123340120	66-310334010,000	66-51033401.0 Meg.
66-1153340150	66-312334012,000	66-51233401.2 Meg.
66-1183340180	66-315334015,000	66-51533401.5 Meg.
66-1203340200	66-318334018,000	66-51833401.8 Meg.
66-1223340220	66-320334020,000	66-52033402.0 Meg.
66-1253340250	66-322334022,000	66-52233402.2 Meg.
66-1273340270	66-325334025,000	66-52533402.5 Meg.
66-1303340300	66-327334027,000	66-52733402.7 Meg.
66-1333340330	66-330334030,000	66-53033403.0 Meg.
66-1393340390	66-333334033,000	66-53333403.3 Meg.
66-1403340400	66-335334035,000	66-53533403.5 Meg.
66-1453340450	66-339334039,000	66-53933403.9 Meg.
66-1473340470	66-340334040,000	66-54033404.0 Meg.
66-1503340500	66-347334047,000	66-54733404.7 Meg.
66-1563340560	66-350334050,000	66-55033405.0 Meg.
66-1603340600	66-356334056,000	66-56033406.0 Meg.
66-1683340680	66-360334060,000	66-56833406.8 Meg.
66-1753340750	66-368334068,000	66-58233408.2 Meg.
66-1803340800	66-370334070,000	66-610334010.0 Meg.
66-1823340820	66-375334075,000	66-612334012.0 Meg.
66-21033401000	66-382334082,000	66-615334015.0 Meg.
66-21233401200	66-4103340100,000	66-620334020.0 Meg.
66-21533401500	66-4123340120,000		



CARBON RESISTORS—1-WATT



LIST PRICE

15c
EACH

The famous Philco system of quality control insures the superior performance of Philco carbon resistors.

The features of these resistors include permanently anchored leads, rugged resistance element, and molded, insulating covering. The resulting noise-free operation and freedom from shorts assure long, dependable service.

● COLOR CODED

● SIZE 1.16" x .280"

● TOLERANCE 10%

PART NUMBER	RESISTANCE IN OHMS	PART NUMBER	RESISTANCE IN OHMS	PART NUMBER	RESISTANCE IN OHMS
66-0104340	10	66-2204340	2000	66-4184340	180,000
66-0124340	12	66-2224340	2200	66-4204340	200,000
66-0154340	15	66-2254340	2500	66-4224340	220,000
66-0184340	18	66-2274340	2700	66-4254340	250,000
66-0204340	20	66-2304340	3000	66-4274340	270,000
66-0224340	22	66-2334340	3300	66-4304340	300,000
66-0254340	25	66-2354340	3500	66-4334340	330,000
66-0274340	27	66-2394340	3900	66-4354340	350,000
66-0304340	30	66-2404340	4000	66-4394340	390,000
66-0334340	33	66-2474340	4700	66-4404340	400,000
66-0394340	39	66-2504340	5000	66-4474340	470,000
66-0404340	40	66-2564340	5600	66-4504340	500,000
66-0474340	47	66-2604340	6000	66-4564340	560,000
66-0504340	50	66-2654340	6500	66-4604340	600,000
66-0564340	56	66-2684340	6800	66-4684340	680,000
66-0684340	68	66-2704340	7000	66-4704340	700,000
66-0754340	75	66-2754340	7500	66-4804340	800,000
66-0824340	82	66-2804340	8000	66-4824340	820,000
66-1104340	100	66-2824340	8200	66-4904340	900,000
66-1124340	120	66-2904340	9000	66-5104340	1.0 Meg.
66-1154340	150	66-3104340	10,000	66-5124340	1.2 Meg.
66-1184340	180	66-3124340	12,000	66-5154340	1.5 Meg.
66-1204340	200	66-3154340	15,000	66-5184340	1.8 Meg.
66-1224340	220	66-3184340	18,000	66-5204340	2.0 Meg.
66-1244340	240	66-3204340	20,000	66-5224340	2.2 Meg.
66-1254340	250	66-3224340	22,000	66-5254340	2.5 Meg.
66-1274340	270	66-3254340	25,000	66-5274340	2.7 Meg.
66-1304340	300	66-3274340	27,000	66-5304340	3.0 Meg.
66-1334340	330	66-3304340	30,000	66-5334340	3.3 Meg.
66-1394340	390	66-3334340	33,000	66-5354340	3.5 Meg.
66-1404340	400	66-3354340	35,000	66-5394340	3.9 Meg.
66-1454340	450	66-3394340	39,000	66-5404340	4.0 Meg.
66-1474340	470	66-3404340	40,000	66-5474340	4.7 Meg.
66-1504340	500	66-3474340	47,000	66-5504340	5.0 Meg.
66-1564340	560	66-3504340	50,000	66-5564340	5.6 Meg.
66-1604340	600	66-3564340	56,000	66-5604340	6.0 Meg.
66-1684340	680	66-3604340	60,000	66-5684340	6.8 Meg.
66-1754340	750	66-3684340	68,000	66-5824340	8.2 Meg.
66-1804340	800	66-3704340	70,000	66-6104340	10.0 Meg.
66-1824340	820	66-3754340	75,000	66-6124340	12.0 Meg.
66-2104340	1000	66-3824340	82,000	66-6154340	15.0 Meg.
66-2124340	1200	66-4104340	100,000	66-6204340	20.0 Meg.
66-2154340	1500	66-4124340	120,000		
66-2184340	1800	66-4154340	150,000		



**PART NUMBER SYSTEM FOR
STANDARD-TYPE FIXED RESISTORS**

Part Number

The part number consists of a prefix 66- and a suffix of seven digits. For example: 66-9393340. To aid in explaining the numbering system, the number is separated into four groups, each of which is identified by a letter, as follows:

66- 000 0 0 00
a b c d e

a. Prefix 66- designates a fixed standard resistor.

b. In the suffix, the first three digits represent the resistance value in ohms; the second and third digits are the first and second significant figures, respectively. For values of 10 ohms or greater, the first digit (up to 6) designates the number of zeros following the first two significant figures. For values under 10 ohms, the first digit is either 9 or 8, and designates one or two decimal places, respectively, to the left of the last significant figure.

c. The fourth digit designates the wattage, as follows:

NUMBER	WATTS	NUMBER	WATTS
1	1/4	5	2
3	1/2*	6	3
4	1	7	4

* 1/2 watt, small type only, is designated by number 8.

d. The fifth digit designates the percentage tolerance of the rated resistance value, as follows:

NUMBER	% TOLERANCE
2	5
3	10
5	20

e. The sixth and seventh digits represent characteristics of special interest to engineers; this information may be obtained from the Philco Corporation Standards.

Special-type fixed resistors have part numbers which do not conform to the above system.



LIST PRICE

25c

EACH

CARBON RESISTORS — 2-WATT

Similar in construction to the 1-watt type, Philco 2-watt carbon resistors are designed for superior performance where extra power dissipation is required. These resistors are conservatively rated and compactly constructed.

● COLOR CODED

● SIZE 1.75" x .342"

● TOLERANCE 10%

PART NUMBER	RESISTANCE IN OHMS	PART NUMBER	RESISTANCE IN OHMS
66-0565340	56	66-2825340	8200
66-0685340	68	66-3105340	10,000
66-1105340	100	66-3125340	12,000
66-1185340	180	66-3155340	15,000
66-1225340	220	66-3185340	18,000
66-1335340	330	66-3225340	22,000
66-1475340	470	66-3275340	27,000
66-1825340	820	66-3335340	33,000
66-2105340	1000	66-3395340	39,000
66-2125340	1200	66-3475340	47,000
66-2155340	1500	66-3685340	68,000
66-2185340	1800	66-4105340	100,000
66-2225340	2200	66-4125340	120,000
66-2295340	2900	66-4225340	220,000
66-2335340	3300	66-4275340	270,000
66-2395340	3900	66-4395340	390,000
66-2475340	4700	66-4685340	680,000
66-2565340	5600		



WIRE-WOUND RESISTORS 1-WATT



LIST PRICE

17c

EACH

PHILCO 1-watt wire-wound resistors are specially designed to withstand heavy overloads and high-humidity conditions. They are layer-wound to provide maximum heat dissipation with minimum size, and they are insulated for maximum protection in limited spaces.

These resistors are useful in television sets, radios and other equipment requiring resistors with conservative rating and excellent stability.

PART NUMBER	RESISTANCE IN OHMS	PART NUMBER	RESISTANCE IN OHMS	PART NUMBER	RESISTANCE IN OHMS
66-9154360	1.5	66-0334360	33	66-1334360	330
66-9184360	1.8	66-0394360	39	66-1394360	390
66-9274360	2.7	66-0474360	47	66-1474360	470
66-9334360	3.3	66-0564360	56	66-1564360	560
66-9474360	4.7	66-0684360	68	66-1684360	680
66-9824360	8.2	66-1104360	100	66-1824360	820
66-0104360	10	66-1124360	120	66-2104360	1000
66-0154360	15	66-1154360	150	66-2154360	1500
66-0184360	18	66-1184360	180	66-2224360	2200
66-0224360	22	66-1224360	220	66-2334360	3300
66-0274360	27	66-1274360	270	66-2474360	4700

WIRE-WOUND RESISTORS 10-WATT



PHILCO 10-watt resistors have an enamel coating, which gives better performance with wide humidity variations.

Mounted on bracket supports, these resistors are built to withstand overloads and current surges which often occur in power supplies and similar circuits.

PART NUMBER	RESISTANCE IN OHMS	LIST PRICE	PART NUMBER	RESISTANCE IN OHMS	LIST PRICE	PART NUMBER	RESISTANCE IN OHMS	LIST PRICE
33-1336	100	\$.75	33-1336-10	820	.75	33-1336-17	3900	.75
33-1336-1	150	.75	33-1336-11	1000	.75	33-1336-18	5100	.75
33-1336-2	200	.75	33-1336-12	1200	.75	33-1336-19	6200	.85
33-1336-3	240	.75	33-1336-51	1300	.75	33-1336-20	7500	.85
33-1336-4	300	.75	33-1336-13	1500	.75	33-1336-21	10,000	.90
33-1336-5	390	.75	33-1336-14	2000	.75	33-1336-22	12,000	1.00
33-1336-7	510	.75	33-1336-15	2400	.75	33-1336-23	15,000	1.00
33-1336-8	620	.75	33-1336-16	3000	.75	33-1336-24	20,000	1.00
33-1336-9	680	.75				33-1336-25	24,000	1.10



ADJUSTABLE RESISTORS

PHILCO adjustable resistors are wound on oversized ceramic cores; this feature assures long service at conservative power ratings.

The vitreous-enamel coating is non-porous, to provide special protection against humidity; it is rugged, to give positive protection against physical injury from the sliding contact bands and other objects which might damage the resistance winding.

The heavy-duty terminal lugs used are specially designed to handle high current and multiple-soldered joints.

Primarily designed for voltage-dividing networks in power supplies, and for voltage-dropping circuits, Philco adjustable resistors will fill most general requirements.

The wattage dissipation is proportional to the length of the conducting element. For example, a tap set halfway from the end of a 50-watt resistor safely will dissipate 25 watts over the half used.

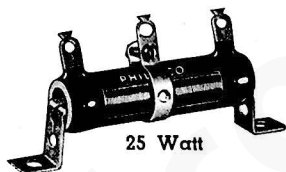
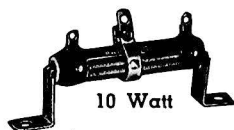

PART NUMBER	RESISTANCE IN OHMS	WATTS	SIZE	LIST PRICE
45-4000	50	10	1 3/4" x 3/16"	\$0.75
45-4000-1	150	10	1 3/4" x 3/16"	.75
45-4000-2	200	10	1 3/4" x 3/16"	.75
45-4000-3	300	10	1 3/4" x 3/16"	1.25
45-4000-4	75	25	2 1/2" x 3/8"	1.05
45-4000-5	300	25	2 1/2" x 3/8"	1.05
45-4000-6	500	25	2 1/2" x 3/8"	1.05
45-4000-7	100	50	4 1/2" x 3/8"	1.65
45-4000-8	200	50	4 1/2" x 3/8"	1.65
45-4000-9	500	50	4 1/2" x 3/8"	1.65



EXTRA CONTACT BANDS

Extra contact bands are available to fit not only Philco adjustable resistors, but also most other similar resistors in use. These bands are cadmium-plated for good conductivity and resistance to rust.

PART NUMBER

LIST PRICE

45-6386 For 10-watt resistors \$0.30
 45-6386-1 For 25 and 50-watt resistors .30

PHILCO PHONOGRAPH PICKUPS

Philco phonograph pickups have the finest arms and cartridges available for replacement in phonographs and radio-phonographs.

Available in different colors and with different physical and electrical characteristics, Philco phonograph pickups are described below with information necessary for proper replacement. Carefully balanced and designed, these pickups will give years of excellent performance. Philco phonograph pickups are especially suited for modernizing old-model phonographs and record players.



Finished in attractive brown crinkle, this is the ideal inexpensive arm for use with the L-26 crystal cartridge. Frequency range: 50-4500 cycles. Output: 1.4 volts. Needle pressure: $2\frac{3}{4}$ oz. Length from needle to spindle: $7\frac{1}{2}$ ". Includes 6-8-volt pilot light and bayonet socket.

PART NO. 35-2068 LIST PRICE \$6.50



Featherweight needle pressure. Arm finished in light brown. Uses P-87-B crystal cartridge with frequency range of 60-6000 cycles. Output: 1.6 volts. Length from needle to spindle: $7\frac{1}{4}$ ". 14" cable.

PART NO. 45-1502 LIST PRICE \$8.00



A beautiful, efficient, molded-bakelite arm with weatherproof crystal cartridge. Finished in dark brown. First made for Philco Model 41-601. Output: 1.4 volts. Needle pressure: $1\frac{1}{2}$ oz. Length from needle to spindle: $7\frac{1}{8}$ ".

PART NO. 35-2524 LIST PRICE \$7.50



A higher-quality arm finished in striking sun-tan hammer tone. Uses a P-90-S crystal cartridge with frequency range of 50-7000 cycles. Output: 1.6 volts. Needle pressure: $\frac{3}{4}$ oz. Length from needle to spindle: $6\frac{3}{4}$ ". First made for Philco D-10 changer.

PART NO. 35-2641 LIST PRICE \$12.00

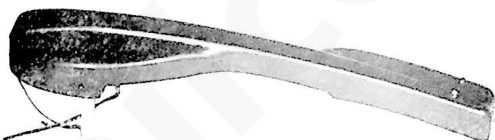

Finished in subtle grey hammer tone, a beautiful pickup arm measuring $7\frac{1}{4}$ " from needle to spindle. Supplied in choice of crystal cartridge P-90-S or P-30-S. Output voltage: 1.7 volts. Frequency range: 50-7000 cycles. Needle pressure with P-90-S cartridge: $\frac{3}{4}$ oz.; with P-30-S cartridge: 1 oz. First made for Philco M-8 changer.

PART NO.		LIST PRICE
35-2663	(P-90-S cartridge)	\$11.00
35-2663-2	(P-30-S cartridge)	10.00

PHILCO DYNAMIC REPRODUCERS

Beautiful pickup arms, featuring finest moving-coil units for truly excellent fidelity. Delicately balanced for long needle and record life. Part No. 35-2648 is finished in striking sun-tan hammer tone. Length from needle to spindle: $6\frac{3}{4}$ ". Part No. 76-1725 is finished in refreshing green, and gives finest performance.

PART NO.	LIST PRICE
35-2648	\$17.00
76-1725	23.00

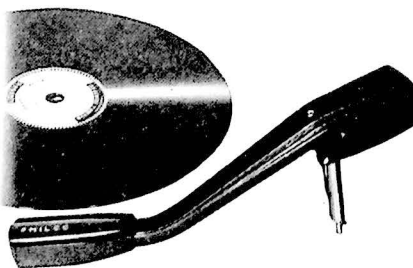



PHILCO CRYSTAL-PICKUP CARTRIDGES

Philco crystal-pickup cartridges are manufactured under the famous Philco system of quality control.

Designed for replacement in practically any phono-pickup arm in use, the exact replacement can be determined by the data given below.

Firm needle chucks insure steady needle pressure on record, providing minimum "wow" and "needle talk."

Philco crystal-pickup cartridges replace all makes; they should be used in the place of old cartridges which are causing decreased volume output.

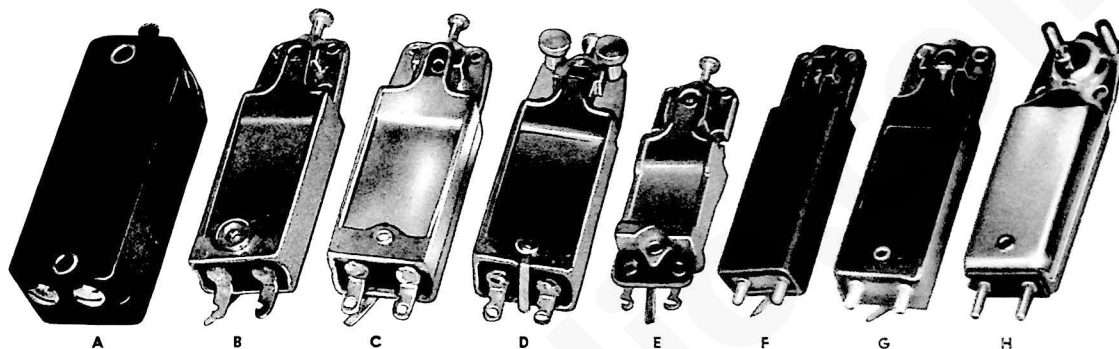

PART NO	FIG.	MAXIMUM NEEDLE PRESSURE IN OUNCES	MINIMUM OUTPUT VOLTAGE	CUT-OFF FREQUENCY IN C.P.S.	TERMINALS	NEEDLE SCREW	LIST PRICE
35-2030	A	2¾	2.5	5000	Universal	218-1047	\$5.00
35-2069	B	2¾	1.75	5000	Lug	218-1047	5.00
35-2204	C	2¾	1.4	4500	Lug	218-1047	5.00
35-2569	D	1¼	.6	4500	Lug	218-1047	4.00
415-1027	E	2¾	2.9	6500	Lug	218-1047	5.00
35-2643	F	¾	1.6	7000	Pin	218-1047	4.40
35-2658	G	1½	1.4	7000	Pin	218-1047	9.25
35-2671-1	H	1	.9	7000	Pin	*45-3031	5.00
35-2674	H	1	.3	7000	Pin	*45-3031	9.50
35-2690	H	1	.65	7000	Pin	*45-3031	13.00

* KNURLED NUT

PHILCO PHONO-MOTOR RUBBER DRIVES



For replacement on all popular phono motors and record changers. Use Philco Rubber Cement for fastening to shaft or pulley.

Supplied individually packaged, or on attractive display card of 20 packages.

PART NO.	DIMENSION INCHES			NO. OF UNITS PER PKG.	USED ON	LIST PRICE
	I.D.	O.D.	THICK			
45-9141*	2	2¾	5/32	2	General Industries and Alliance	\$0.40
45-9142*	1½	1¾	3/16	2	Motorola	.40
45-9143*	7/8	1⅓	3/16	3	RCA	.40
45-9144*	1/8	3/8	1/4	4	Philco, RCA, etc.	.40
45-9145*	5¾	6	3/16	1	Detrola	.40

45-9140-20 Special display card holding 5 packages each of Part Nos. 45-9141, 45-9142, 45-9143, 45-9144... \$8.00

*Standard carton of 20 packages (add suffix "20" to part number) \$8.00



PHILCO MODEL M-15 ALBUM-LENGTH RECORD PLAYER



The Philco Model M-15 Album-Length Record Player, designed to play the new, sensational Columbia Long-Playing Microgroove Records, embodies the latest and finest developments in the art of music reproduction. Employing the Philco Balanced-Fidelity Reproducer and a dynamically balanced low-speed motor and turntable, amazingly low needle pressure and free tone-arm movement is obtained. Designed for attachment to any Philco or other make of radio, radio-phonograph, or phonograph having a modern type of audio amplifying system, Model M-15 is housed in a handsome modernistic cabinet. This new type of record player leads the way in recorded music pleasure.

PART NO.
43-5035

LIST PRICE
ZONE 1—\$29.95
ZONE 2— 31.50

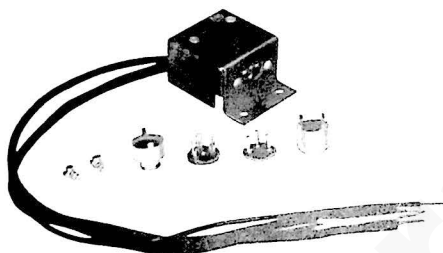

PHILCO ADAPTER CONTROL KIT

The Philco Adapter Control Kit is used for connecting the Philco Model M-15 Album-Length Record Player to any modern radio, radio-phonograph combination, or phonograph amplifier. The one switch that is included in the kit may be installed, by use of the complete instructions included with the kit, for use as a radio-phono switch on any modern radio or as a phonograph changeover switch for any radio-phonograph combination or phonograph amplifier. A plug kit is included with the Adapter Control Kit for convenience of installation to any Philco radio-phonograph combination equipped with a 3-prong phono receptacle.

PART NO.		LIST PRICE
45-1594-1	Adapter Kit Complete	\$2.50
45-9532	Plug Kit Only	.50

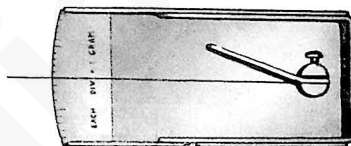

PHILCO GRAM SCALE

A precision instrument designed specifically for measuring needle pressure, as well as vertical and horizontal friction of the lightweight tone arms used in the Philco Album-Length Record Players. The Philco Gram Scale consists of a long, flat pointer spring set in a movable pivot, and has an easy-to-read scale calibrated to measure pressures from 1 to 20 grams.

PART NO.
45-1614

DEALER NET PRICE
\$1.30



PHILCO STROBOSCOPE DISC

The new Philco Stroboscope Disc combines two stroboscopes on one disc. The inner stroboscope is used for adjusting the speed of the conventional 78.26 r.p.m. turntables, and the outer stroboscope is used for adjusting the speed of the new 33 1/3 r.p.m. turntables, used in the Philco Album-Length Record Players.

PART NO.
45-9531

LIST PRICE
\$0.15



PHILCO AUTOMATIC RECORD CHANGER AND RECORD PLAYER COMBINATION MODEL M-9C



By simply operating a switch on the Philco M-9C Automatic Record Changer and Record Player, standard 10- or 12-inch records, or the new Columbia Long-Playing Records may be played. Designed to operate on 117 volts, 60 cycles, and incorporating two tone arms, one used in conjunction with the automatic record-changer mechanism for standard records, and the other embodying the Balanced-Fidelity reproducer for playing the Columbia Long-Playing Records manually, the M-9C is the latest Philco advancement in recorded music reproduction.

Each tone arm is equipped with a semi-permanent type needle designed to give long and satisfactory use.

PART NO.
45-9537

LIST PRICE
\$62.95

PHILCO AUTOMATIC RECORD CHANGER MODEL M-9

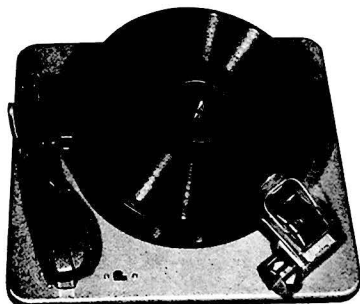

The Philco Automatic Record Changer Model M-9 is the record changer used in several 1948 Philco radio-phonograph combinations. It is designed to operate on 117 volts, 60 cycles, and to play ten standard-type 12" records or twelve standard-type 10" records automatically or manually in a smooth and efficient manner.

Each changer comes equipped with a Philco Featherweight Needle, which is a precision-ground needle designed for long life and a higher reproducing fidelity.

PART NO.
45-9533

LIST PRICE
\$39.95

PHILCO RECORD CHANGER AND CHANGER BASE MODEL D-10



Philco Automatic Record Changer Model D-10 is designed for long years of smooth, quiet, and efficient automatic playing of records.

Used in several 1946 Philco radio-phonograph combinations, the Model D-10 is easily installed for operation with any radio. It can be mounted directly on a baseboard or on a steel-frame stand.

The changer operates on 117 volts, 60 cycles, and will play either ten 12" records or twelve 10" records by automatic or manual operation.

The offset pickup arm with permanent needle assures perfect tracking and fine tone. Supplied complete with instructions.

PART NO. 45-9521
PART NO. 76-3932

Model D-10 Changer
Changer Base

LIST PRICE \$44.45
LIST PRICE \$5.50



PHILCO RECORDING BLANKS

Especially designed for home recording. Philco safety recording blanks are engineered for the best fidelity and tone with home-recording apparatus.

These blanks feature an acetate-base coating on an unbreakable metal disc, to provide fine, life-like recordings in tough, durable form. A smooth, free thread, with no sticking or piling is a special feature of the acetate-base coating.

The surface coating is fire-proof and explosion-proof, and is approved by Underwriters Laboratories.

Supplied in 6½", 8", and 10" sizes.

PART NO.	SIZE	LIST PRICE
45-2982.....	6½".....	Pkg. of 6, \$1.50
45-2983.....	8".....	Pkg. of 6, 2.10
45-2984.....	10".....	Pkg. of 6, 3.00

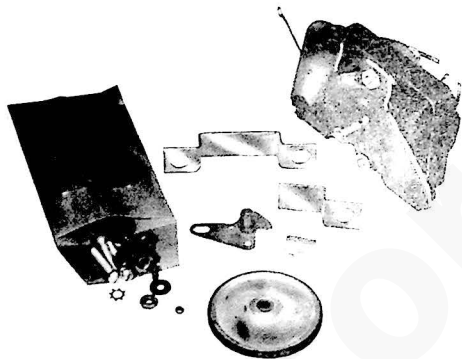

PHILCO MOTOR KITS

Philco motor kits are designed for replacement of the prime-mover units in 1941 and 1942 Philco record changers.

Kit Part No. 45-1549 replaces the 1941 changer motor 318-2802.

Kit 45-1548, which is illustrated, consists of the motor and parts for converting from variable-speed bell-drive to single-speed rim-drive, for improved changer performance. The kit replaces the 1942 changer motor 35-1275.

Supplied with layout template and complete instructions.

PART NO.	DESCRIPTION	PART NO.
45-1548	Motor kit (for 1942 changers)	\$18.00
45-1549	Motor kit (for 1941 changers)	14.00

PHILCO SAPPHIRE NEEDLE

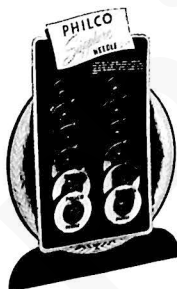

Sensitive to the brilliant high frequencies, yet so smoothly polished as to practically eliminate surface noise, this needle has the ideal jewel point for reducing record wear to a minimum. It will play thousands of records with natural tone reproduction.

Supplied on an attractive display card of twelve needles, individually packaged in tamper-proof containers.

PART NO.	LIST PRICE
45-1529	\$30.00
*45-1533	30.00

PHILCO HI-QUALITY NEEDLE

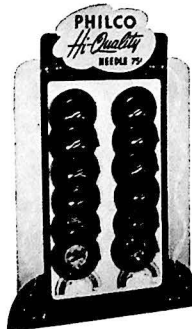

The Philco Hi-Quality needle is exactly what its name implies—a high-quality unit with a finely-polished, precious-metal tip, for dependable performance. The Philco Hi-Quality needle is the low-cost leader in the permanent-needle field.

Supplied on an attractive display card of twelve needles, individually packaged.

PART NO.	LIST PRICE
45-1531	\$9.00
*45-1535	9.00

* Items noted with asterisk are supplied in boxes of 12 for Merchandiser Replacement (see page 236).



**PHILCO HOME
RECORDING
NEEDLES**

Excellent for home recorders of every make, Philco cutting needles are precision made. They are accurately angled to throw a free thread, and are polished to extremely close tolerances for truly quiet recordings with high fidelity.

Individually inspected. Made of hand-lapped Swedish steel. Supplied on card of five.

PART NO.
45-2824

LIST PRICE
(Card of Five) \$1.25

**PHILCO ALBUM-LENGTH RECORD
PLAYER NEEDLE**



The Philco Album-Length Record Player Needle is designed for playing the new Columbia Long-Playing "Microgroove" Records. This remarkable precious-metal-tip needle operates with only 1/5 ounce needle pressure, to provide unbelievably realistic reproduction with an extremely low amount of needle talk and needle scratch, and to insure longer life for your Columbia Long-Playing "Microgroove" Records.

PART NO.
45-1613

LIST PRICE
\$1.00

**SAPPHIRE NEEDLE FOR PHILCO
DYNAMIC PICKUP**



The Philco sapphire needle is specially designed for use with side-bracket guards to prevent needle damage. The guards protect the delicate needle point from breaking or chipping, to insure long needle and record life. Individually packaged.

PART NO.
45-1596 Needle
56-4407 Guard (2 needed)

LIST PRICE
\$2.25
\$0.15ea

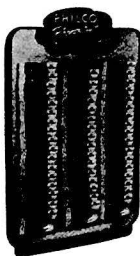

**PHILCO FILTER-POINT
NEEDLES**

Philco Filter-Point needles are a real dealer item, featuring fine, stainless-alloy units at low price. Supplied on an attractive display card of fifty packages, with twenty-five needles to a package.

PART NO.
45-1546

LIST PRICE
\$12.50

PHILCO LONG-LIFE NEEDLE



The Philco Long-Life needle is accurately offset for correct tracking and cushioned action, to provide excellent tonal quality with a minimum of record wear.

Supplied on an attractive display card of twelve needles, individually packaged.

PART NO.
45-1530
*45-1534

LIST PRICE
\$18.00
18.00

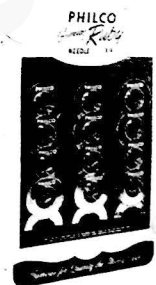

PHILCO RUBY NEEDLE

The Philco genuine ruby needle is precision-made to insure pure reproduction and long service.

Featuring deluxe jewel point, for life-like tone and minimum record wear, the Philco ruby needle will play more than 10,000 recordings—actually years of listening pleasure.

A special grinding and polishing process gives the Philco ruby needle a true and smooth record ride, for minimum surface noise and needle talk.

Supplied on an attractive display card of twelve needles, individually packaged.

PART NO.
45-1528
*45-1532

LIST PRICE
\$42.00
42.00

PHILCO FEATHERWEIGHT NEEDLE



The Philco Featherweight needle, the finest of its kind, is designed for unusual listening pleasure. This needle is made of the best grade of stainless steel, and is precision-ground and polished. Individually packaged.

PART NO.
45-1597

LIST PRICE
\$1.50



PHILCO LIGHT-BEAM REPRODUCER PARTS

The original fine performance of Philco light-beam reproducers may be restored by these replacement parts, which are exact duplicates of original components. These parts are correct replacements for units in the light-beam assembly using the early zinc tone-arm shell and the later aluminum and bakelite tone-arm shells.

Additional information on replacement tone-arm shells and complete light-beam reproducers is given below.

The photo-cell assembly (Part No. 318-2741) illustrated is for use with the bakelite type of tone arm only. When the aluminum shell is used to replace a zinc shell, the old photo-cell housing should be retained.

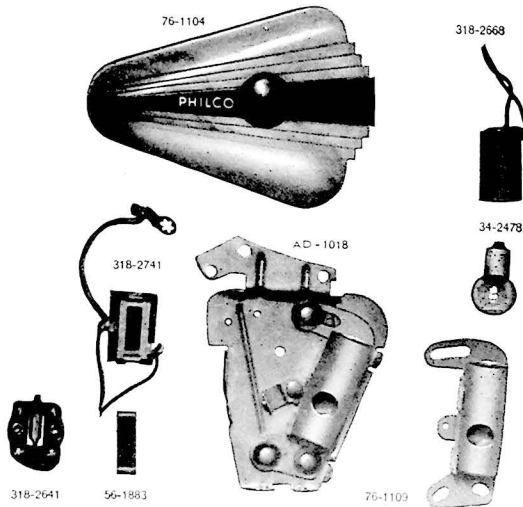

PART No.	DESCRIPTION	LIST PRICE
AD-1018	Tone-arm head	\$2.25
34-2478	Light-beam lamp	.45
56-1883	Photo-cell element	3.00
76-1104	Cover, tone-arm head	1.10
318-2641	Jewel assembly	5.75
318-2668	Lamp-socket assembly	1.60
318-2741	Photo cell assembly	4.50

PHILCO LIGHT-BEAM REPLACEMENT TONE-ARM SHELLS

Philco zinc tone-arm shells are replaced with the aluminum shell (Part No. 28-7334), shown at the left, and bakelite tone-arm shells are replaced with Part No. 54-4145. Both the aluminum and bakelite shells are finished in beautiful brown hammertone.

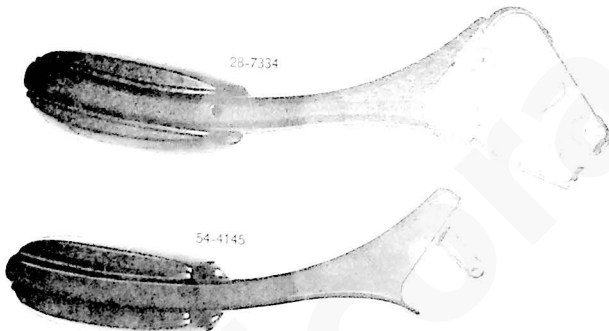

PART No.	TYPE	LIST PRICE
28-7334FC56	Tone-arm shell, aluminum	\$2.25
54-4145	Tone-arm shell, bakelite	7.50

COMPLETE REPLACEMENT LIGHT-BEAM REPRODUCERS

The group of light beam reproducers listed at the right can be assembled from the available parts which are listed above, provided the hardware from the original tone arm is used.

35-2175	35-2361	35-2540
35-2209	35-2517	35-2601
35-2233	35-2518	
35-2281	35-2519	

PHILCO CLUTCH GEAR

The Philco clutch gear is designed as a replacement for the unit in 1942 Philco record changers. Accurately machined and polished, this new clutch gear is made of treated brass, to give much longer and more satisfactory service than the original bakelite part.

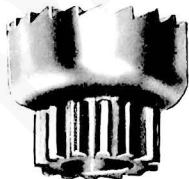

PART NO.
45-6388

LIST PRICE
\$6.75

PHONO PARTS (Cont.)

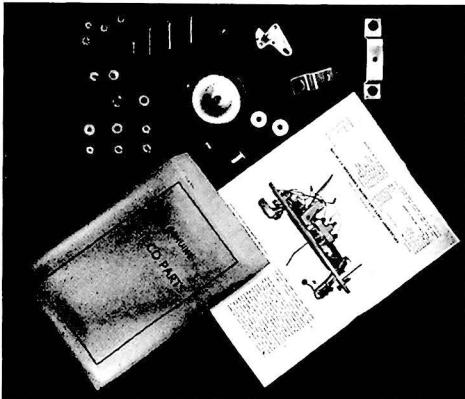

**PHILCO
 PHONOGRAPH MOTOR
 CONVERSION KIT**

Converts 1942 Philco record changers with variable-speed drive to single-speed rim drive. Recommended where only single speed operation is desired for improved changer performance.

Kit includes all parts and hardware necessary for conversion, together with complete instructions.

PART No. 45-1496 LIST PRICE \$2.95

**Universal
 Phonograph Motor Coupling**

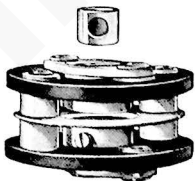

Fits 1940 and 1941 PHILCO standard record changers and many other makes; completely re-designed and constructed of rust-proofed steel with Neoprene flexible members. Much longer life than old design.

PART No. 35-2220 LIST PRICE — \$2.65
 Replaces old Parts Numbers 35-2220-1 and 35-2270.

PHILCO METAL HOLE CUTTER

Cuts steel, brass, aluminum, plastics, plywood up to .040" thick. Cuts straight lines, circles or compound curves. Clean Edge, no filing necessary.

For cuts inside edges of panel, drill one 1/4" pilot hole to start. Tool steel blade, tungsten carbide shear blocks. Perfect for Philco rear seat speaker installation. Should fit 1/4" chuck on drill.

PART NO.	DEALER NET PRICE
45-9525	Metal Cutter
45-9526	Blade
	\$15.95
	1.00

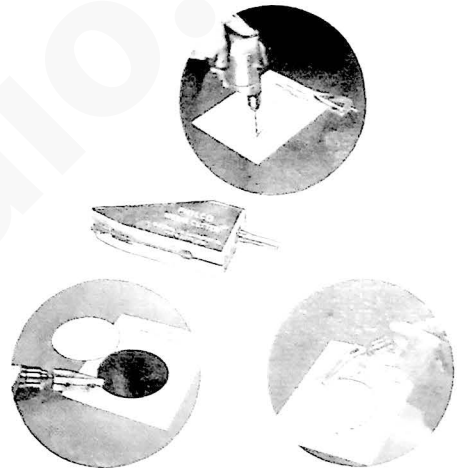

**PHILCO
 TRIP-
 CONVERSION
 KIT**

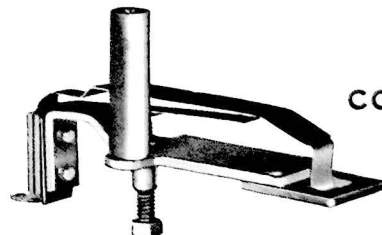

The Philco trip-conversion kit contains all parts necessary to convert the velocity-type trip-contact assembly on 1942, Model M51 changers, to the new, improved type of trip-contact assembly used on Philco Automatic Record Changer Model M-4.

Complete instructions supplied with each kit.

PART NO.	LIST PRICE
45-1565	\$4.00



PHILCO SCREW DRIVERS AND WRENCHES

The Philco line of unbreakable-handle screw drivers and wrenches is especially designed for radio and other electrical-system adjustments.

Made of tough, amber-colored plastic, the handles can withstand hammer blows; the handles are joined immovably with the sturdy alloy-steel shanks.

Supplied in a variety of sizes to meet every need.

INSULATED ROUND-BLADE SCREW DRIVER

45-6347



PART NO.	TYPE NO.	SIZE OF BLADE	OVERALL LENGTH	LIST PRICE
45-6347	PVR-241	1/8" x 4"	6 1/4"	\$0.60
45-6347-1	PVR-261	1/8" x 6"	8 3/8"	.66

ROUND-BLADE SCREW DRIVER (with pocket clip)

46-6353-1
(With Pocket Clip)



PART NO.	TYPE NO.	SIZE OF BLADE	OVERALL LENGTH	LIST PRICE
45-6353	PA 010C	3/32" x 1 5/8"	3 1/2"	\$0.25
45-6353-1	PA 116-2C	3/32" x 2"	5 1/4"	.35
45-6353-2	PA 116-3-C	3/32" x 2"	4 1/4"	.35

ROUND-BLADE SCREW DRIVER



45-6352
(Midget)

45-6354



PART NO.	TYPE NO.	SIZE OF BLADE	OVERALL LENGTH	LIST PRICE
45-6354	PA 216-R-4-C	1/8" x 4"	6 1/2"	\$0.53
45-6354-1	PA 216-R-6-C	1/8" x 6"	8 1/2"	.55
45-6354-2	PA 216-R-8-C	1/8" x 8"	10 1/2"	.58
45-6352	PA-000-C	3/32" x 1 5/8"	3"	.15

ROUND-BLADE SCREW DRIVER (with screw-holding clip)

45-6341



PART NO.	TYPE NO.	SIZE OF BLADE	OVERALL LENGTH	LIST PRICE
45-6341	PK-303	3/16" x 3"	6 3/4"	\$0.76
45-6341-1	PK-306	3/16" x 6"	9 1/2"	.86
45-6341-2	PK-308	3/16" x 8"	12"	.90

INSULATED-SHAFT POCKET-CLIP SCREW DRIVER

45-6346



PART NO.	TYPE NO.	SIZE OF BLADE	OVERALL LENGTH	LIST PRICE
45-6346	PA-86	1/8" x 3/4"	6 1/4"	\$0.65

SQUARE-BLADE SCREW DRIVERS



45-6338-4

45-6340
(Stubby Type)

45-6339
(With Pocket Clip)

45-6338

PART NO.	TYPE NO.	SIZE OF BLADE	OVERALL LENGTH	LIST PRICE
45-6338	PC-58	5/16" x 8"	12 1/2"	\$1.38
45-6338-1	PC-24	1/8" x 4"	6 1/2"	.70
45-6338-2	PC-26	1/8" x 6"	8 1/2"	.68
45-6338-3	PC-33	3/16" x 3"	6 1/4"	.80
45-6338-4	PC-36	3/16" x 6"	9 1/4"	.90
45-6338-5	PC-46	1/4" x 6"	9 3/4"	1.05
45-6340	PC-41	1/4" x 1"	2"	.85
45-6339	PC-22	1/8" x 2"	3"	.55

ALL-PURPOSE PLIERS (with wire-cutter section)

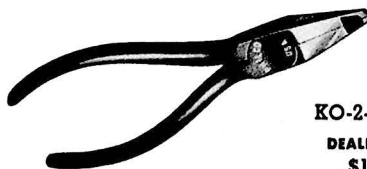

KO-2-1001-1
DEALER NET
\$1.45

PHILCO SCREW DRIVERS AND WRENCHES (Cont.)

HEXAGON WRENCHES



45-6349-1 45-6348-4 45-6348-9 45-6348-2 45-6348

PART NO.	TYPE NO.	SOCKET SIZE	OVERALL LENGTH	LIST PRICE
45-6348	PS-6	3/16"	6"	\$0.80
45-6348-1	PS-8	1/4"	6"	.80
45-6348-2	PS-10	5/16"	6"	.80
45-6348-3	PS-11	11/32"	6"	.80
45-6348-4	PS-12	3/8"	6"	.90
45-6348-5	PS-14	7/16"	6"	1.00
45-6349	PS-160	1/2"	7"	1.38
45-6349-1	PS-180	9/16"	7"	1.38

ALIGNING SCREW DRIVER AND WIRE-DRESSING TOOL

45-2610 

PART NO.	SOCKET SIZE	OVERALL LENGTH	LIST PRICE
45-2610	1/16" x 3/16"	7 1/4"	\$0.60

REVERSIBLE SCREW DRIVER

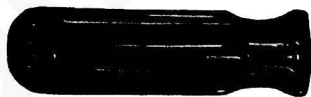

PART NO.	SIZE OF HALF BLADE	OVERALL LENGTH	LIST PRICE
45-9516	4"	8 1/2"	\$1.20

CONDENSER-NUT WRENCHES



PART NO.	TYPE NO.	SOCKET SIZE	OVERALL LENGTH	LIST PRICE
45-6351	PS-32	31/32"	6"	\$1.45
45-6351-1	PS-36	15/32"	6 3/4"	1.45

INSULATED-SHAFT HEXAGON SOCKET WRENCH



PART NO.	TYPE NO.	SOCKET SIZE	OVERALL LENGTH	LIST PRICE
45-6350	PS-40	1/4" I.D.	5 3/4"	\$1.00

PHILLIPS SCREW DRIVERS

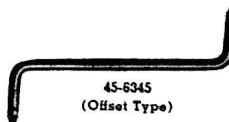

PART NO.	TYPE NO.	*SIZE OF BLADE	OVERALL LENGTH	LIST PRICE
45-6343	PP-1	No. 1—3"	5 1/2"	\$0.90
45-6343-1	PP-2	No. 2—4 1/4"	8 1/2"	1.05
45-6343-2	PP-3	No. 3—6"	10"	1.40
45-6344	PP-28	No. 2—8"	11 3/4"	1.12
45-6344-1	PP-38	No. 3—8"	12"	1.55
45-6345	PP-120	No. 1 & No. 2—4 1/2"	4 1/2"	.55
45-6342	PP-101	No. 1—3"	5 3/8"	1.00

* No. 1 For Phillips screw up to size 4 & smaller
 No. 2 For Phillips screw sizes 5 to 9
 No. 3 For Phillips screw sizes 10 to 16

PHILCO SCREW DRIVERS AND WRENCHES (Cont.)

KEY WRENCHES

Three popular sets, for all standard-size setscrews used in electronic equipment. Made of precision-tool steel, tempered, and rust-proofed.



PART NO.	DESCRIPTION	LIST PRICE
45-9270	Assortment of 4 small HEX wrenches. Fits set screws No. 4 to 1/4" and cap screws No. 2 to No. 8	\$0.40
45-9270-20	Standard carton of 20 packages No. 45-9270.	\$8.00
45-9271	Assortment of 3 medium HEX wrenches. Fits set screws 1/4" to 7/16" and cap screws No. 8 to 15/16"	.40
45-9271-20	Standard carton of 20 packages No. 45-9271.	\$8.00
45-9275	Assortment of 4 small SPLINE wrenches. Fits all set screws up to 1/4" and cap screws up to No. 8	.40
45-9275-20	Standard carton of 20 packages No. 45-9275.	\$8.00

FIBRE ALIGNMENT SCREW DRIVERS

Uses a tough, bone-fibre, precision-milled tip inserted in a polystyrene handle. This tool contains no metal parts whatsoever, and possesses good mechanical strength.



PART NO.	DESCRIPTION	LIST PRICE
45-8880	Fibre alignment screw driver	\$0.40
45-8880-20	Display card of 20 tools No. 45-8880.	\$8.00
45-6436	Tool for K-Tran I.F.s.	.75
45-6436-12	Display card of 12 tools No. 45-6436.	\$9.00

COMBINATION WRENCH AND SCREW DRIVER



A handy tool consisting of a 1/4" fibre wrench, combined with a plastic screw driver. The hexagon shape of the wrench extends through the entire length of the handle. The end, therefore, may be cut off when worn.

PART NO.	DESCRIPTION	LIST PRICE
45-8879	Combination tool	\$0.80
45-8879-20	Display card with 20 tools No. 45-8879.	\$12.00



TUNING WAND

For checking the alignment of circuits without changing adjustments. The wand is brass-loaded at one end and steel-loaded at the other. Supplied on attractive display card of 20 wands.

PART NO.	DESCRIPTION	LIST PRICE
45-8885	Tuning Wand	\$0.50
45-8885-20	Display card of 20 wands No. 45-8885.	\$10.00

1/4" ALIGNMENT WRENCH

Standard hexagon wrench used for alignment purposes. The internal hexagon shape extends through the entire length so that the ends can be cut off when worn out. Available in fibre for high mechanical strength, or polystyrene for low loss. Over-all length: 7 1/2".



PART NO.	DESCRIPTION	LIST PRICE
45-8875	1/4" fibre wrench	\$0.40
45-8875-12	Display card of 12 tools No. 45-8875.	\$4.80
45-8876	1/4" polystyrene wrench	.40
45-8876-12	Display card of 12 tools No. 45-8876.	\$4.80
7696	1/4" bakelite wrench (8")	.35
45-8877	5/16" fibre wrench	.40
45-8877-12	Display card of 12 tools No. 45-8877.	\$4.80
45-8878	5/16" polystyrene wrench	.40
45-8878-12	Display card of 12 tools No. 45-8878.	\$4.80

PHILCO TOOL KITS

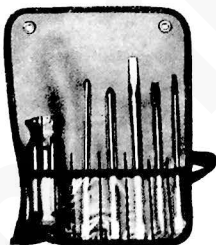

PART NO.	DESCRIPTION	LIST PRICE
45-9514	Tool kit and leatherette bag—screw-driver combination (Phillips and Standard blade)	\$3.35
45-9515	Tool kit and leatherette bag—hexagon-wrench combination 7/16", 9/8", 11/32", 5/16", 1/4"	\$3.90
45-9536	Handle only	\$0.55

METAL-TIP ALIGNMENT SCREW DRIVER

Combines low capacity with high mechanical strength. Made with small metal tip and polystyrene handle.



PART NO.	DESCRIPTION	LIST PRICE
45-8882	Alignment screw driver	\$0.45
45-8882-20	Display card of 20 tools No. 45-8882.	\$9.00

PHILCO

*Famous for Quality
the World Over*

SERVICE AIDS

PHILCO RADIO AND SPEAKER CEMENT



For the repair of speakers and for general radio repair work. This cement dries quickly, and has excellent adhesive qualities. It is vibration-proof, and always retains a certain amount of resiliency, which is an important factor in the repair of speaker cones and other vibrating components. Supplied singly or in attractive display carton.

PART NO.	DESCRIPTION	LIST PRICE
45-8501	1 3/4-oz. tube	\$0.55
45-8501-12	—Display carton of 12 tubes No. 45-8501.	\$6.60
45-8502	2-oz. bottle	.60
45-8502-12	—Display carton of 12 bottles No. 45-8502.	\$7.20
45-8504	4-oz. bottle	1.10
45-8504-12	—Standard carton of 12 bottles No. 45-8504.	\$13.20
45-8508	8-oz. bottle	1.60
45-8508-12	—Standard carton of 12 bottles No. 45-8508.	\$21.00
45-8509	1-gal. cans	12.50
45-8509-3	—Standard carton of 3 cans No. 45-8509.	\$37.50

PHILCO CEMENT SOLVENT



Made especially for loosening and removing cement on speaker cones, frames, voice coils, etc. It may also be used for thinning radio cement and plastic cement. Supplied singly or in attractive display carton. Will not damage speaker cones. Non-injurious to paper, cloth or wire.

Dries rapidly when used as thinner with Philco radio cement and plastic cement.

PART NO.	DESCRIPTION	LIST PRICE
45-8572	2-oz. bottle	\$0.50
45-8572-12	—Display carton of 12 bottles No. 45-8572.	\$6.00
45-8574	4-oz. bottle	.65
45-8574-12	—Display carton of 12 bottles No. 45-8574.	\$7.80
45-8578	8-oz. bottle	.90
45-8578-12	—Standard carton of 12 bottles No. 45-8578.	\$10.80
45-8579	1-gal. can	5.25
45-8579-3	—Standard carton of 3 cans No. 45-8579.	\$15.75

PHILCO PLASTIC CEMENT



Truly all-purpose, indispensable in every workshop, tool kit, and home. Radio men will find it excellent for cementing grille cloth and grille screening, repairing broken plastic cabinets, and attaching station call tabs to push buttons. This cement makes an outstanding model aircraft and household cement, as it will join almost any article made of wood, china, plastic, leather, etc. It will dry fast and is weatherproof. Supplied singly or in attractive display carton.

PART NO.	DESCRIPTION	LIST PRICE
45-8511	1 3/4-oz. tube	\$0.55
45-8511-12	—Display carton of 12 tubes No. 45-8511.	\$6.60
45-8512	2-oz. bottle	.60
45-8512-12	—Display carton of 12 bottles No. 45-8512.	\$7.20
45-8514	4-oz. bottle	1.10
45-8514-12	—Display carton of 12 bottles No. 45-8514.	\$13.20

SPEAKER ADJUSTMENT SHIMS



Made of non-magnetic spring-temper. nickel-alloy metal. They are strong, flexible, and corrosion resistant, and are clearly identified as to size. Indispensable to the radio serviceman for properly adjusting voice coils in speakers.

PART NO.	DESCRIPTION	LIST PRICE
45-9205	16 assorted shims—4 sizes	\$0.60
45-9205-20	—Display card of 20 packages No. 45-9205.	\$12.00

SPEAKER CONE PATCHES



Made of a special fibrous material and coated with an adhesive which will form a permanent bond with the speaker cone. These patches provide a fast and excellent method for repairing tears in speaker cones.

PART NO.	DESCRIPTION	LIST PRICE
45-9206	Assortment of 10 various sizes of patches	\$0.40
45-9206-20	—Standard carton of 20 packages No. 45-9206.	\$8.00



PHILCO CONTACT CLEANER



For use on all contacts in electronic and electrical devices such as switches, relays, controls, etc. Cleans and protects the contact surfaces or contact points by providing a film which counteracts oxidation and reduces friction. Philco Contact Cleaner is superior to straight cleaning compounds, and radio servicemen will find it indispensable in correcting noisy action in push-button switches, volume controls, band switches, etc.

PART NO.	SIZE	LIST PRICE
45-8602	2-oz. bottle	\$0.50
45-8602-12—Display carton of 12 bottles No. 45-8602, \$6.00		
45-8604	4-oz. bottle	.75
45-8604-12—Display carton of 12 bottles No. 45-8604, \$9.00		
45-8608	8-oz. bottle	1.00
45-8608-12—Standard carton of 12 bottles No. 45-8608, \$12.00		
45-8609	1-pt. can	1.80
45-8609-12—Standard carton of 12 cans No. 45-8609, \$21.60		

PHILCO RUBBER CEMENT



New type adhesive, especially designed for joining rubber parts to metal, wood, etc. Typical applications in radio work are the fastening of dial or phono drives to shafts, attaching shock mounts and grommets to chassis, and cementing rubber feet to cabinets. This cement may also be used wherever a bond of great flexibility is required, such as cementing cloth to cloth, cloth to rubber, etc. Philco Rubber Cement has many applications in industry, automotive repair, hobby shop, and the home.

PART NO.	SIZE	LIST PRICE
45-8522	2-oz. bottle	\$0.60
45-8522-12—Display carton of 12 bottles No. 45-8522, \$7.20		
45-8524	4-oz. bottle	1.10
45-8524-12—Display carton of 12 bottles No. 45-8524, \$13.20		

SPECIAL LUBRICANT



A light-body lubricating grease containing certain chemicals to prevent oxidation of contacts and eliminate noisy operation of controls, switches, relays, etc. This compound may be freely applied to all contact parts, as it will have no effect on the electrical characteristics of the circuit. Treated contacts are protected from oxidation, and will give trouble-free service for a much longer period of time.

PART NO.	SIZE	LIST PRICE
45-8611	1 3/4-oz. applicator tube	\$0.55
45-8611-12—Display carton of 12 tubes No. 45-8611, \$6.60		

PHILCO POLYSTYRENE COIL COATING AND CEMENT



A coil dope of outstanding electrical quality, to be used in coating coils for all frequency ranges, including ultra-high and television circuits. Coated articles become moistureproof. Due to the high Q and low loss of this material the electrical characteristics of coils and other components coated with this compound will not be changed. This product is also an excellent cement for all items made of polystyrene.

PART NO.	SIZE	LIST PRICE
45-8534	4-oz. bottle	\$1.00
45-8534-12—Display carton of 12 bottles No. 45-8534, \$12.00		

THINNER FOR POLYSTYRENE COIL COATING

PART NO.	SIZE	LIST PRICE
45-8584	4-oz. bottle	\$0.45
45-8584-12—Display carton of 12 bottles No. 45-8584, \$5.40		



PHILCO FLOCK FINISH KIT

Complete; contains all materials for flock finishing. Included are Philco flock spray gun, undercoat and flock in ivory and brown shades, thinner, brushes, and instructions.

PART NO.	SIZE	LIST PRICE
45-8805	One complete kit	\$11.90
45-8805-3—Standard carton of three kits No. 45-8805, \$35.70		
45-8806	Felt Flock Spray Gun	4.35
45-8806-6—Standard carton of 6 guns No. 45-8806, \$26.10		

PHILCO FELT FLOCK UNDERCOAT

Acts as an adhesive and color base for the felt flock. It is applied like ordinary enamel or paint. Packed in 8-oz. cans sufficient to cover approximately 10 square feet of surface (two coats may be required if applied on absorbent material such as plaster, soft wood, etc.).

PART NO.	COLOR	LIST PRICE
45-8700*	Brown	\$1.65
45-8701*	Ivory	1.65
45-8702*	Blue	1.65
45-8703*	Taupe	1.65
45-8704*	Red	1.65
45-8705*	Green	1.65
45-8706*	White & Silver	1.65
45-8708*	Black	1.65
*Standard carton of 6 cans of felt flock undercoat—(Add suffix -6 to catalog number), \$9.90		

PHILCO THINNER FOR FELT FLOCK UNDERCOAT

Required for washing out brushes or for thinning undercoat whenever necessary.

PART NO.	SIZE	LIST PRICE
45-8718	8-oz. can	\$0.55
45-8718-6—Standard package of 6 cans No. 45-8718, \$3.30		

PHILCO GRILLE CLOTH



Comes in beautiful patterns to blend with every cabinet. Specially woven so as not to interfere with the projection and distribution of sound.

PART NO.	SIZE	LIST PRICE
45-8775	12" x 12"	\$0.60
45-8775-12—Standard carton of 12 pieces No. 45-8775, \$7.20		
45-8776	18" x 24"	1.50
45-8776-12—Standard carton of 12 pieces No. 45-8776, \$18.00		
45-8777	36" x 50"	6.25
45-8777-2—Standard carton of 2 pieces No. 45-8777, \$12.50		

PHILCO FELT FLOCK

Made of bright and attractively colored rayon fibres of even length to insure uniform coating. Each package contains flock to cover an area of 5 to 7 square feet.

PART NO.	COLOR	LIST PRICE
45-8690*	Brown	\$1.65
45-8691*	Ivory	1.65
45-8692*	Blue	1.65
45-8693*	Taupe	1.65
45-8694*	Red	1.65
45-8695*	Green	1.65
45-8696*	Silver	1.65
45-8697*	White	1.65
45-8698*	Black	1.65
*Standard carton of 6 cans of felt flock add suffix -6 to catalog number, \$9.90		

PHILCO GRILLE SCREENING

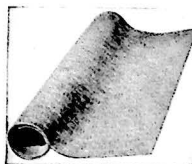

Galvanized and completely covered with attractive rayon flock. Same as used in many modern radio sets, P.A. systems, automobile radios, inter-coms., coin phonographs, etc. Being waterproof, this screening may readily be used for outdoor installation. The ivory screening may be dyed to any color.

PART NO.	SIZE	LIST PRICE
45-8780	8" x 11", Brown	\$0.85
45-8780-12—Standard carton of 12 pieces No. 45-8780, \$10.20		
45-8781	8" x 11", Ivory85
45-8781-12—Standard carton of 12 pieces No. 45-8781, \$10.20		



PHILCO INSULATING TUBING ASSORTMENTS

Contains a variety of types and colors of "spaghetti." Included are saturated sleeving, lacquered and varnished tubing, and synthetic extruded insulation for high-voltage work (up to 15,000 volts).

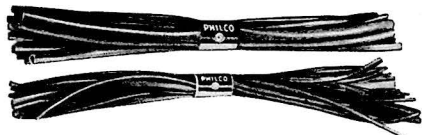

PART NO.	DESCRIPTION	LIST PRICE
45-8840	18-ft. assorted tubing, cut in handy 1-ft. lengths —small sizes, No. 20 to No. 9 B & S gauge.....	\$0.90
45-8840-36	—Display ctn. of 36 No. 45-8840 assortments,	\$32.40
45-8841	10-ft. assorted tubing, cut in handy 1-ft. lengths —large sizes, No. 8 B & S gauge to 1/2" I.D.....	.90
45-8841-24	—Display ctn. of 24 No. 45-8841 assortments,	\$21.60



PHILCO LIQUID DIAL-CORD DRESSING

Increases the friction on dial cords and belts. It is easy to apply with the built-in brush. It penetrates deeply for lasting effect, and it dries very fast. May be applied freely, and assists in preserving the dial cord from the effects of moisture and strain.



DIAL-CORD DRESSING

Supplied in handy stick form, this special dressing is easily applied on cord to prevent slipping. It does not cause cord to harden or deteriorate, and one application lasts indefinitely.

PART NO.	LIST PRICE
45-6118	\$0.60

PART NO.	SIZE	LIST PRICE
45-8622	2-oz. bottle75
45-8622-12	—Display carton of 12 bottles No. 45-8622,	\$9.00



PHILCO CRYSTALLIZING LACQUERS

Especially prepared for the radio man to patch and refinish panels, cabinets, chassis, etc. They are of brushing consistency, and will dry in less than one hour. These finishes may be used on plastics, metal, glass, etc.

PART NO.	SIZE	LIST PRICE
45-8670	2-oz. jar Gray Crystallizing Lacquer.....	\$0.60
45-8670-3	—Standard carton of 3 jars No. 45-8670,	\$1.80
45-8680	16-oz. can Gray Crystallizing Lacquer.....	3.00
45-8680-3	—Standard carton of 3 cans No. 45-8680,	\$9.00
45-8671	2-oz. jar Black Crystallizing Lacquer.....	.60
45-8671-3	—Standard carton of 3 jars No. 45-8671,	\$1.80
45-8681	16-oz. can Black Crystallizing Lacquer.....	3.00
45-8681-3	—Standard carton of 3 cans No. 45-8681,	\$9.00
45-8675	2-oz. jar Blue Hammer Finish Lacquer.....	.60
45-8675-3	—Standard carton of 3 jars No. 45-8675,	\$1.80
45-8685	16-oz. can Blue Hammer Finish Lacquer.....	3.00
45-8685-3	—Standard carton of 3 cans No. 45-8685,	\$9.00



PHILCO ALL-PURPOSE LUBRICATOR

Philco All-Purpose Lubricator is especially designed for lubrication of items where an electrical contact is made, such as noisy radio push-button switches, band switches, tone switches, etc. Its superiority lies in the fact that it maintains a film of high electrical conductivity on the surface of the switch contacts.

It is unexcelled for the lubrication of fishing reels, guns, office equipment, and household equipment.

PART NO.	LIST PRICE
45-2806	\$0.35

PHILCO DIAL CORDS

Backed by Philco research and quality control, these cords are the same as used in the original equipment. Only the best raw materials are used, to provide low stretch, high resistance to abrasion, and long service life.

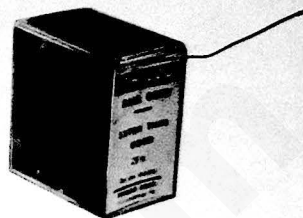

PHILCO EXTRA-THIN CORD

Used extensively in midget radios, some automobile radios, and small table models. The diameter is approximately .027".

PHILCO STANDARD THIN CORD

The most popular size cord, used in most table and console radio models. Very strong and durable. Approximate diameter: .033".

PHILCO MEDIUM CORD

Used on most larger sets. This cord has a high breaking strength, and is treated to prevent slipping. Approximate diameter: .040".

PART NO.	SIZE	LIST PRICE	PART NO.	SIZE	LIST PRICE	PART NO.	SIZE	LIST PRICE
45-9285	10-ft. package	\$0.40	45-9290	8-ft. package	\$0.40	45-9295	8-ft. package	\$0.40
	45-9285-20—Display carton of 20 packages No. 45-9285, \$8.00			45-9290-20—Display carton of 20 packages No. 45-9290, \$8.00			45-9295-20—Display carton of 20 packages No. 45-9295, \$8.00	
45-8750	25-ft. spool	1.25	45-8755	25-ft. spool	1.25	45-8760	25-ft. spool	1.45
	45-8750-12—Display carton of 12 spools No. 45-8750, \$15.00			45-8755-12—Display carton of 12 spools No. 45-8755, \$15.00			45-8760-12—Display carton of 12 spools No. 45-8760, \$15.00	
45-8751	100-ft. spool	4.50	45-8756	100-ft. spool	4.50	45-8761	100-ft. spool	4.25
	45-8751-12—Display carton of 12 spools No. 45-8751, \$54.00			45-8756-12—Display carton of 12 spools No. 45-8756, \$54.00			45-8761-12—Display carton of 12 spools No. 45-8761, \$54.00	

PHILCO HEAVY CORD

For replacement on sets requiring a large-diameter (1/16") dial-drive cord.

PART NO.	SIZE	LIST PRICE
45-9280	6-ft. package	\$0.40
	45-9280-20—Display carton of 20 packages No. 45-9280, \$8.00	

PHILCO BRAIDED BRONZE CABLE

Very strong, with a fiberglass core. Does not unravel. Approximate diameter: .038".

PART NO.	SIZE	LIST PRICE
45-9282	10-ft. package	\$0.40
	45-9282-20—Display carton of 20 packages No. 45-9282, \$8.00	

PHILCO PHOSPHOR BRONZE CABLE

42-strand, extra-flexible. For replacement on dials of many older sets, and for use wherever an extra-flexible and strong connection is required in electrical and electronic work. Approximate diameter: 1/32".

PART NO.	SIZE	LIST PRICE
45-9281	5-ft. package	\$0.40
	45-9281-20—Display carton of 20 packages No. 45-9281, \$8.00	

PHILCO SPECIAL THIN BRONZE CABLE

8-strand braided, .022" diameter, as used in dial drives of RCA and General Electric, as well as many export sets.

PART NO.	SIZE	LIST PRICE
45-9283	10-ft. package	\$0.40
	45-9283-20—Display carton of 20 packages No. 45-9283, \$8.00	

PHILCO DRIVE BELTS

Constructed of high-quality rubber, reinforced with molded-in cord. They are precision made, will not stretch in normal use, and are treated to prevent slipping. Philco belts are put up in three convenient kit forms for use by service shops, for general belt replacement purposes.

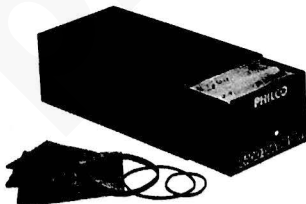

PART NO.	DESCRIPTION	LIST PRICE
45-8812	Kit of 25 belts. Contains the most frequently used belts for Zenith, Emerson, and other popular makes of sets	\$6.25
	45-8812-3—Standard carton of 3 dial belt kits No. 45-8812, \$18.75	
45-8813	Kit of 50 belts. Contains most frequently used sizes for all popular makes of sets	12.50
	45-8813-3—Standard carton of 3 kits No. 45-8813, \$37.50	
45-8814	Kit of 100 belts. This kit includes every size belt for every standard make radio	25.00
	45-8814-3—Standard carton of 3 kits No. 45-8814, \$75.00	



PHILCO FURNITURE POLISH

A high quality, hard-finish polish, developed by the Philco Cabinet Engineering Department, to restore the original lustre to the most delicate surface of fine furniture and radio cabinets. Quick and effective—no hard rubbing.

Part No. 45-1175 List Price \$0.50

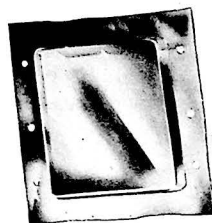

PHILCO DIAL WINDOWS

Philco dial windows are available in a variety of shapes and sizes for replacement of dial windows, clocks, etc. Easily trimmed and cemented.

PART NO.	SIZE IN INCHES	LIST PRICE
27-5472	2½ x 3	\$0.45
27-5593	2 x 8½	.30
27-5616	3 x 4	.40
27-5636	3¼ x 6½	.50
54-4088	3 x 3¾	.35
45-8795	6" (Round)	1.10
(45-8795-12—Standard carton of 12 crystals No. 45-8795, \$13.20)		
45-8796	9" (Round)	1.80
(45-8796-6—Standard carton of 6 crystals No. 45-8796, \$10.80)		
45-8797	8" x 10" (Flat)	1.65
(45-8797-6—Standard carton of 6 sheets No. 45-8797, \$9.90)		

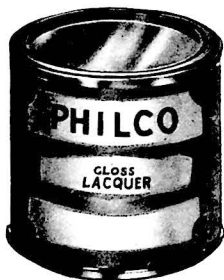

PHILCO GLOSS LACQUER

An easily applied lacquer for finishing radio cabinets. Specially designed to produce a sheer gloss on radio cabinets and furniture—a gloss that sparkles beautifully.

Made of synthetic-resin base developed after years of research, Philco gloss lacquer is approved by the Philco finishing laboratories. Supplied in 1-qt. cans.

Part No. 45-6362 List Price \$3.00



PHILCO RUBBING COMPOUND

For cabinets and furniture, this highly efficient composition, containing an extremely fine abrasive in paste form, is used by Philco for the final rubbing operation in finishing cabinets of all radio models. Supplied in 1-qt. can.

Part No. 45-1527 List Price \$3.35



PHILCOTE REFINISHING STAINS AND LACQUERS

Philcote Stains and Lacquers are designed to faithfully reproduce the original finish on all Philco cabinets and any other cabinets where a beautiful finish is desired.

Laboratory tested under ultra-violet rays, Philcote stains will not fade after prolonged exposure to sunlight. The use of alcohol as a base, instead of water, prevents raising of the

grain, thus eliminating the necessity for sanding, and insuring a more even finish.

Philco Finishing Research Laboratories have produced in Philcote lacquer enamels, a well-balanced formula that is free from cracking, even under conditions of extreme cold.

Supplied in one quart cans and available in various shades—use Philcote for a finer finish.

REFRIGERATOR AND AIR CONDITIONER TOUCH UP MATERIAL

For restoring the original appearance of Refrigerator and Air Conditioner Cabinets. Available in the following sizes:

PART NO.	DESCRIPTION	SIZE	LIST PRICE
8901-14	White Duco	1 Qt.	\$3.80
8901-18	White Duco	1 Qt.	3.60
8901-24	Primer	1 Qt.	3.40
8901-30	Rubbing Comp.	1 Qt.	1.20
8901-37	Thinner	1 Qt.	2.20
8901-55	Blush Retarder	1 Qt.	3.80
8901-56	Proxylin Putty	1 Lb. Tube	2.80
8901-57	Cleaner #7	11 Oz.	1.60

PART NO.	DESCRIPTION	LIST PRICE
45-9505	Warm Body Stain	\$2.25
45-9506	Toner Stain	2.75
45-9507	Lacquer Enamel (Bezel Brown)	4.25
45-9508	Mahogany Stain (Brown)	2.25
45-9509	Table Model Stain	2.25
45-9510	Floor Model Stain	2.25
45-9511	Mahogany Stain (Modern)	2.50
45-9512	Tan Stain (Avalordire)	2.25
45-9513	Ground Coat (Beser Maroon)	4.25

MACHINE SCREWS

Standard sizes, cadmium-plated, conveniently packaged, in the sizes most often needed by the serviceman.



PART NO.	DESCRIPTION	LIST PRICE
45-8900	Approximately 40 assorted screws in sizes 6-32, 8-32, 10-32; various lengths.....	\$0.40
45-8900-20	Standard carton of 20 packages No. 45-8900,	\$8.00
45-8902	Approximately 40 screws, size 6-32 x 3/8"....	.40
45-8902-20	Standard carton of 20 packages No. 45-8902,	\$8.00
45-8903	Approximately 35 screws, size 6-32 x 1/2"....	.40
45-8903-20	Standard carton of 20 packages No. 45-8903,	\$8.00
45-8904	Approximately 30 screws, size 6-32 x 3/4"....	.40
45-8904-20	Standard carton of 20 packages No. 45-8904,	\$8.00
45-8907	Approximately 35 screws, size 8-32 x 3/8"....	.40
45-8907-20	Standard carton of 20 packages No. 45-8907,	\$8.00
45-8909	Approximately 25 screws, size 8-32 x 3/4"....	.40
45-8909-20	Standard carton of 20 packages No. 45-8909,	\$8.00
45-8912	Approximately 20 screws, size 10-32 x 3/4"....	.40
45-8912-20	Standard carton of 20 packages No. 45-8912,	\$8.00

SHEET-METAL SCREWS

Self-tapping type, made of hardened steel, and cadmium-plated.



PART NO.	DESCRIPTION	LIST PRICE
45-8920	Approximately 30 assorted screws, sizes No. 6, 8 and 10, in various lengths.....	\$0.40
45-8920-20	Standard carton of 20 packages No. 45-8920,	\$8.00
45-8921	Approximately 30 screws, No. 6 x 1/4".....	.40
45-8921-20	Standard carton of 20 packages No. 45-8921,	\$8.00
45-8924	Approximately 20 screws, No. 6 x 3/4"....	.40
45-8924-20	Standard carton of 20 packages No. 45-8924,	\$8.00
45-8926	Approximately 25 screws, No. 8 x 3/8"....	.40
45-8926-20	Standard carton of 20 packages No. 45-8926,	\$8.00
45-8928	Approximately 15 screws, No. 8 x 3/4"....	.40
45-8928-20	Standard carton of 20 packages No. 45-8928,	\$8.00
45-8932	Approximately 15 screws, No. 10 x 3/4"....	.40
45-8932-20	Standard carton of 20 packages No. 45-8932,	\$8.00

SMALL MACHINE SCREWS AND NUTS

A special assortment containing sizes No. 2 and No. 4 for replacing rivets and eyelets, and very handy in model work where extra-small screws are required.

PART NO.	DESCRIPTION	LIST PRICE
45-9240	Approximately 30 screws, with nuts to fit.....	\$0.40
45-9240-20	Standard carton of 20 packages No. 45-9240,	\$8.00

ORNAMENTAL-HEAD SCREWS

Antique-bronze finish, rosette-head type, as used in mounting of speakers, etc.



PART NO.	DESCRIPTION	LIST PRICE
45-8950	Approximately 15 screws, assorted sizes.....	\$0.40
45-8950-20	Standard carton of 20 packages No. 45-8950,	\$8.00

PHONOGRAPH-PICKUP SETSCREWS

Precision-made with knurled head for replacement in pickups and recording heads.



PART NO.	DESCRIPTION	LIST PRICE
45-8955	Approximately 10 assorted pickup screws.....	\$0.40
45-8955-20	Standard carton of 20 packages No. 45-8955,	\$8.00
45-8956	Approximately 10 screws, size 2-56 x 3/8"....	.40
45-8956-20	Standard carton of 20 packages No. 45-8956,	\$8.00
45-8957	Approximately 10 screws, size 2-64 x 3/4" and fit most Astatic and Webster cartridges.....	.40
45-8957-20	Standard carton of 20 packages No. 45-8957,	\$8.00

SETSCREWS

Hardened, slotted steel set screws for use in radio knobs, record changers, dial drives, etc.



PART NO.	DESCRIPTION	LIST PRICE
45-8940	Approximately 15 assorted screws in sizes 6-32, 8-32 and 10-32; various lengths.....	\$0.40
45-8940-20	Standard carton of 20 packages No. 45-8940,	\$8.00
45-8942	Approximately 12 screws, size 6-32 x 3/16"....	.40
45-8942-20	Standard carton of 20 packages No. 45-8942,	\$8.00
45-8945	Approximately 12 screws, sizes 6-32 x 3/16"....	.40
45-8945-20	Standard carton of 20 packages No. 45-8945,	\$8.00
45-8946	Approximately 12 screws, size 8-32 x 1/4"....	.40
45-8946-20	Standard carton of 20 packages No. 45-8946,	\$8.00

RACK-SCREW AND CUP WASHER ASSORTMENT

Used to improve the appearance of mounting panels, record players, etc. Screws and washers are nickel-plated.



PART NO.	DESCRIPTION	LIST PRICE
45-8965	Approximately 1 doz. each, screws and washers.....	\$0.40
45-8965-20	Standard carton of 20 packages No. 45-8965,	\$8.00

SPADE BOLTS

Used for fastening shields, coils, transformers, etc. The assortment contains various lengths of bolts with 6-32 thread.

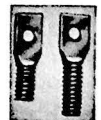

PART NO.	DESCRIPTION	LIST PRICE
45-8970	Approximately 25 assorted spade bolts.....	\$0.40
45-8970-20	Standard carton of 20 packages No. 45-8970,	\$8.00



RUBBER GROMMETS

For protecting cables and for mounting condensers, phono chassis, tube sockets, etc.



PART NO.	DESCRIPTION	LIST PRICE
45-9080	Approximately 12 assorted grommets	\$0.40
45-9080-20	Standard carton of 20 packages No. 45-9080,	\$8.00
45-9081	Approximately 16 grommets, 1/8" I.D. for 1/4" mounting hole	.40
45-9081-20	Standard carton of 20 packages No. 45-9081,	\$8.00
45-9083	Approximately 10 grommets, 1/4" I.D. for 3/8" mounting hole	.40
45-9083-12	Standard carton of 12 packages No. 45-9083,	\$4.80

CORD STRAINRELIEFS

For use on POSJ wire. Also provides a grommet which will prevent the insulation of the wire from being damaged by sharp-edged holes in chassis or cabinet. Use Philco Rubber Cement for attaching to cord.



PART NO.	DESCRIPTION	LIST PRICE
45-9090	4 strainreliefs	\$0.40
45-9090-20	Standard carton of 20 packages No. 45-9090,	\$8.00

CHASSIS MOUNTS

Made of high-grade rubber, with the necessary degree of resilience to absorb vibrations and reduce microphonics when installed between chassis and cabinets.



PART NO.	DESCRIPTION	LIST PRICE
45-9110	Approximately 10 assorted chassis mounts	\$0.40
45-9110-12	Standard carton of 12 packages No. 45-9110,	\$4.80
45-9111	6 chassis mounts, 3/4" diameter	.40
45-9111-12	Standard carton of 12 packages No. 45-9111,	\$4.80
45-9112	4 chassis mounts, 1" diameter	.40
45-9112-12	Standard cartons of 12 packages No. 45-9112,	\$4.80

RUBBER WASHER AND BUMPER ASSORTMENT

For general electronic repair work. Includes a variety of washers, bumpers, and pads, to eliminate vibration and rattles, and to prevent microphonics.

PART NO.	DESCRIPTION	LIST PRICE
45-9255	Approximately 20 assorted washers and bumpers	\$0.40
45-9255-12	Standard carton of 12 packages No. 45-9255,	\$4.80

DIAL-DRIVE SPRINGS

Provides the necessary tension on the dial-drive cord. Made of high-quality spring steel, cadmium-plated.



PART NO.	DESCRIPTION	LIST PRICE
45-9115	Approximately 10 assorted dial-drive springs, all popular sizes	\$0.40
45-9115-20	Standard carton of 20 packages No. 45-9115,	\$8.00
45-9120	Approximately 10 assorted dial-drive springs, small sizes only	.40
45-9120-20	Standard carton of 20 packages No. 45-9120,	\$8.00
45-9123	Approximately 10 dial-drive springs 9/16" long, 3/16" diameter	.40
45-9123-20	Standard carton of 20 packages No. 45-9123,	\$8.00
45-9124	8 dial-drive springs, 3/4" long, 1/8" diameter	.40
45-9124-20	Standard carton of 20 packages No. 45-9124,	\$8.00

KNOB SPRINGS

Made of spring steel, and rust-proofed. This assortment contains all popular sizes to fit any standard knobs and shafts.



PART NO.	DESCRIPTION	LIST PRICE
45-9130	Approximately 16 assorted knob springs	\$0.40
45-9130-20	Standard carton of 20 packages No. 45-9130,	\$8.00

COMPRESSION SPRINGS

In two handy assortments, for use in electronic and electrical work.



PART NO.	DESCRIPTION	LIST PRICE
45-9245	Approximately 20 assorted small springs	\$0.40
45-9245-20	Standard carton of 20 packages No. 45-9245,	\$8.00
45-9250	Approximately 15 assorted large springs	.40
45-9250-12	Standard carton of 12 packages No. 45-9250,	\$4.80

EXPANSION SPRINGS

In assorted sizes for record changers and push-button tuners, and for experimental repair work.

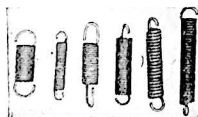

PART NO.	DESCRIPTION	LIST PRICE
45-9230	Approximately 10 assorted large springs	\$0.40
45-9230-20	Standard carton of 20 packages No. 45-9230,	\$8.00
45-9235	Approximately 10 assorted small springs	.40
45-9235-20	Standard carton of 20 packages No. 45-9235,	\$8.00

PHILCO UNIVERSAL SPEAKER BAFFLES

Philco universal speaker baffles are supplied in a variety of sizes, and can be trimmed for exact replacement or for units of original design. These baffles are made of plywood, excellent for the best tone reproduction. Supplied in square and rectangular sizes for round and oval speakers, as listed in the table to the right.

PART NO.	DIMENSIONS IN INCHES			SPEAKER SIZE IN INCHES	LIST PRICE
	HEIGHT	LENGTH	THICKNESS		
219036	5 1/2	14 7/8	1/4	4 x 6	\$2.40
219098	8 1/2	6 7/8	1/2	6 1/2	4.00
219064	7	6 3/4	1/2	7	1.60
219100	10	15	1/2	8	4.50
219087	13 1/2	20 1/2	1/2	12	4.75
219048	14 3/8	17 1/2	3/4	14	12.50



DIAL-CORD CLIPS

Philco dial-cord clips lock dial-cord ends securely, for minimum backlash and permanent calibration of the driven dial. Rustproof and tough.

LIST PRICE PART NO.
\$8.00 45-9117-20

Standard carton of 12 packages, 40 clips per package (assorted sizes).

GRID CAPS

For all standard metal and glass tubes; tinned for easy soldering.



PART NO.	DESCRIPTION	LIST PRICE
45-9180	Approximately 20 assorted caps	\$0.40
45-9180-20—Standard carton of 20 packages No. 45-9180,		\$8.00

SOLDERING LUGS

In various popular sizes to meet all requirements of the electronic maintenance and repair field. Made of tinned brass or copper.



PART NO.	DESCRIPTION	LIST PRICE
45-9170	Approximately 40 assorted soldering lugs	\$0.40
45-9170-20—Standard carton of 20 packages No. 45-9170,		\$8.00

METAL AND INSULATING SPACERS

For raising panels, chassis, and condensers, and for mounting sockets, switches, etc. The assortment contains spacers of various lengths and outside diameters, with hole size to accommodate either No. 6 or No. 8 screws.



PART NO.	DESCRIPTION	LIST PRICE
45-9055	Approximately 12 insulating spacers	\$0.40
45-9055-20—Standard carton of 20 packages No. 45-9055,		\$8.00
45-9025	Approximately 12 metal spacers	.40
45-9025-20—Standard carton of 20 packages No. 45-9025,		\$8.00



SPRING CLIPS
(Fahnestock Type)

For fast wire connection with good electrical contact. Used on experimental set-ups, batteries, test equipment, etc.

PART NO.	DESCRIPTION	LIST PRICE
45-9190	Approximately 12 assorted clips	\$0.40
45-9190-12—Standard carton of 12 packages No. 45-9190,		\$4.80
45-9191	Approximately 20 small clips (for wire gages of No. 16 and smaller)	.40
45-9191-12—Standard carton of 12 packages No. 45-9191,		\$4.80
45-9192	Approximately 12 clips (for wire gages up to No. 12)	.40
45-9192-12—Standard carton of 12 packages No. 45-9192,		\$4.80

PHONE TIPS

For standard jacks. Made of drawn brass, nickel-plated. Easy to solder.



PART NO.	DESCRIPTION	LIST PRICE
45-9200	Approximately 12 tips	\$0.40
45-9200-20—Standard carton of 20 packages No. 45-9200,		\$8.00

ANGLE BRACKETS

For use by repairmen, experimenters, and laboratory. Made of cadmium-plated steel.



PART NO.	DESCRIPTION	LIST PRICE
45-9210	Approximately 15 assorted brackets	\$0.40
45-9210-20—Standard carton of 20 packages No. 45-9210,		\$8.00

ELECTRONIC-HARDWARE ASSORTMENT

Contains over 100 small electronic hardware items, such as screws, nuts, springs, grommets, washers, etc. Handy for experimenters, students, hobbyists.



PART NO.	DESCRIPTION	LIST PRICE
45-9225	Hardware assortment	\$0.40
45-9225-12—Standard carton of 12 packages No. 45-9225,		\$4.80



SPEED NUTS

Required for replacement on many record changers, tuning units, etc. These nuts are easy to install, and are self-locking.



PART NO.	DESCRIPTION	LIST PRICE
45-9012	Approximately 30 assorted speed nuts for screws No. 6 to 1/4"	\$0.40
45-9012-20	Standard carton of 20 packages No. 45-9012,	\$8.00

KNOB FELT WASHERS

Keep cabinets from being scratched by knobs, and prevent rattling on automobile radios. They are made of durable brown felt with 1/4" hole and 3/4" outside diameter.



PART NO.	DESCRIPTION	LIST PRICE
45-9015	Approximately 45 washers	\$0.40
45-9015-12	Standard carton of 12 packages No. 45-9015,	\$4.80

METAL WASHERS

Made of steel, precision-stamped, and cadmium-plated.



PART NO.	DESCRIPTION	LIST PRICE
45-9020	Approximately 80 assorted metal washers	\$0.40
45-9020-20	Standard carton of 20 packages No. 45-9020,	\$8.00
45-9022	Approximately 100 metal washers for No. 6 screw	.40
45-9022-20	Standard carton of 20 packages No. 45-9022,	\$8.00
45-9023	Approximately 100 metal washers for No. 8 screw	.40
45-9023-20	Standard carton of 20 packages No. 45-9023,	\$8.00

LOCK WASHERS

Made of special spring steel, and rust-proofed. This assortment contains all popular sizes for electronic installation, maintenance, and experimental work.



PART NO.	DESCRIPTION	LIST PRICE
45-9030	Approximately 50 washers for screws, sizes from No. 4 to 3/8"	\$0.40
45-9030-20	Standard carton of 20 packages No. 45-9030,	\$8.00

RETAINING RINGS AND 'C' WASHERS

Required in the servicing of volume controls, record changers, dial-drive mechanisms, etc.



PART NO.	DESCRIPTION	LIST PRICE
45-9040	Approximately 35 assorted washers and rings	\$0.40
45-9040-20	Standard carton of 20 packages No. 45-9040,	\$8.00

INSULATING WASHERS

Made of high-grade fibre material. This assortment contains both flat and shoulder-style (extruded) washers to fit all standard-size screws, bolts, jacks, controls, etc.

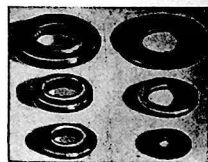

PART NO.	DESCRIPTION	LIST PRICE
45-9050	Approximately 30 assorted fibre washers	\$0.40
45-9050-20	Standard carton of 20 packages No. 45-9050,	\$8.00

SNAP HOLE PLUGS

Used to cover adjustment openings, unused holes, etc. They are precision made, snap in easily, and hold securely.



PART NO.	DESCRIPTION	LIST PRICE
45-9060	6 plugs, assorted sizes	\$0.40
45-9060-20	Standard carton of 20 packages No. 45-9060,	\$8.00

SNAP-IN TRIMOUNTS

Popular for fastening radio back covers, dial and escutcheon plates, etc.



PART NO.	DESCRIPTION	LIST PRICE
45-9070	Approximately 20 assorted trimounts	\$0.40
45-9070-20	Standard carton of 20 packages No. 45-9070,	\$8.00
45-9071	Approximately 20 small trimounts (fit 1/8" hole)	.40
45-9071-20	Standard carton of 20 packages No. 45-9071,	\$8.00
45-9074	Approximately 18 large trimounts (fit 5/32" hole)	.40
45-9074-20	Standard carton of 20 packages No. 45-9074,	\$8.00
45-9075	Approximately 16 long trimounts (fit 5/32" to 3/16" hole)	.40
45-9075-20	Standard carton of 20 packages No. 45-9075,	\$8.00

FUSE CLIPS

Made of spring brass or phosphor-bronze, nickel-plated, for single-hole mounting.



PART NO.	DESCRIPTION	LIST PRICE
45-9185	Approximately 10 clips assorted sizes	\$0.40
45-9185-20	Standard carton of 20 packages No. 45-9185,	\$8.00

CABLE CLAMPS

With No. 8 mounting holes, for all size cables up to 5/16" in diameter. Made of steel, cadmium-plated.



PART NO.	DESCRIPTION	LIST PRICE
45-9185	Approximately 20 assorted cable clamps	\$0.40
45-9185-20	Standard carton of 20 packages No. 45-9185,	\$8.00



SMALL COTTER AND HAIRPINS

Invaluable in the repair of radios and phonograph mechanisms. This package contains an assortment carefully selected to fill the majority of service requirements.



PART NO.	DESCRIPTION	LIST PRICE
45-9221	Approximately 50 assorted pins.....	\$0.40
45-9221-20	Standard carton of 20 packages No. 45-9221,	\$8.00

RIVETS AND EYELETS

Various sizes from 1/16" to 3/16" in diameter, and up to 3/4" in length.



PART NO.	DESCRIPTION	LIST PRICE
45-9215	Approximately 60 assorted rivets.....	\$0.40
45-9215-20	Standard carton of 20 packages No. 45-9215,	\$8.00
45-9220	Approximately 50 assorted eyelets.....	.40
45-9220-20	Standard carton of 20 packages No. 45-9220,	\$8.00

SMALL ESCUTCHEON AND WOOD-SCREW ASSORTMENT

Used by radio men, model builders, etc., for fastening name plates, escutcheons, etc.



PART NO.	DESCRIPTION	LIST PRICE
45-9260	Approximately 50 assorted screws.....	\$0.40
45-9260-20	Standard carton of 20 packages No. 45-9260,	\$8.00

WING NUTS

Made of steel, and bright cadmium-plated. Used mainly in automobile radio, experimental, and industrial maintenance work.



PART NO.	DESCRIPTION	LIST PRICE
45-9005	Approximately 10 assorted nuts, sizes 6-32, 8-32 and 10-32.....	\$0.40
45-9005-20	Standard carton of 20 packages No. 45-9005,	\$8.00

ACORN NUTS

Bright polished and self-locking. They are used for mounting panel assemblies, etc.



PART NO.	DESCRIPTION	LIST PRICE
45-9010	Approximately 12 nuts, assorted sizes 6-32, 8-32 and 10-32.....	\$0.40
45-9010-20	Standard carton of 20 packages No. 45-9010,	\$8.00

ESCUTCHEON PINS

Brass finish, round heads; various sizes included in this assortment.

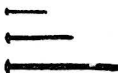

PART NO.	DESCRIPTION	LIST PRICE
45-9265	Approximately 100 pins.....	\$0.40
45-9265-20	Standard carton of 20 packages No. 45-9265,	\$8.00

HEX NUTS

Standard and small-pattern nuts to fit all size screws and bolts as commonly used in radio and electronic assemblies. Heavily cadmium-plated.



PART NO.	DESCRIPTION	LIST PRICE
45-8975	Approximately 40 nuts, assorted sizes from No. 6-32 to No. 10-32.....	\$0.40
45-8975-20	Standard carton of 20 packages No. 45-8975,	\$8.00
45-8978	Approximately 40 nuts, size No. 6-32.....	.40
45-8978-20	Standard carton of 20 packages No. 45-8978,	\$8.00
45-8979	Approximately 35 nuts, size No. 8-32.....	.40
45-8979-20	Standard carton of 20 packages No. 45-8979,	\$8.00
45-8980	Approximately 30 nuts, size No. 10-32.....	.40
45-8980-20	Standard carton of 20 packages No. 45-8980,	\$8.00

MOUNTING NUTS

Standard sizes, precision-made. Bright cadmium or nickel-plated for switches, potentiometers, controls, etc.



PART NO.	DESCRIPTION	LIST PRICE
45-8985	Approximately 12 standard volume-control hex nuts: size 3/8" x 32.....	\$0.40
45-8985-20	Standard carton of 20 packages No. 45-8985,	\$8.00
45-8990	Approximately 12 standard toggle-switch hex nuts: size 15/32" x 32.....	.40
45-8990-20	Standard carton of 20 packages No. 45-8990,	\$8.00
45-8995	Approximately 10 toggle-switch ring nuts: size 15/32" x 32.....	.40
45-8995-20	Standard carton of 20 packages No. 45-8995,	\$8.00

KNURLED THUMB NUTS

Precision-made and turned of solid brass. They are used for battery connections, experimental set-ups, test instruments, etc.



PART NO.	DESCRIPTION	LIST PRICE
45-9000	Approximately 12 knurled thumb nuts, assorted sizes 6-32, 8-32 and 10-32.....	\$0.40
45-9000-20	Standard carton of 20 packages No. 45-9000,	\$8.00
45-9001	Approximately 15 knurled thumb nuts, size 6-32.....	.40
45-9001-20	Standard carton of 20 packages No. 45-9001,	\$8.00
45-9002	Approximately 12 knurled thumb nuts, size 8-32.....	.40
45-9002-20	Standard carton of 20 packages No. 45-9002,	\$8.00

STANDARD WOOD SCREWS

A handy assortment for workshop or home. Contains various sizes of round and flat-head screws.



PART NO.	DESCRIPTION	LIST PRICE
45-9263	Approximately 30 assorted screws.....	\$0.40
45-9263-20	Standard carton of 20 packages No. 45-9263,	\$8.00

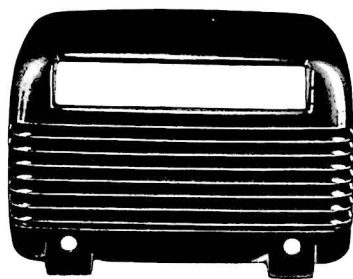

46-250 and PT2

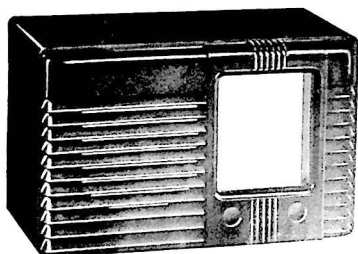

PT25

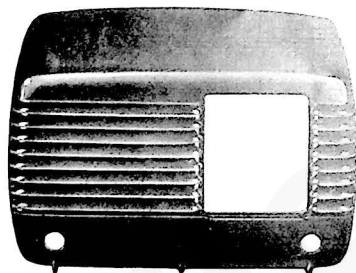

46-200 and PT91

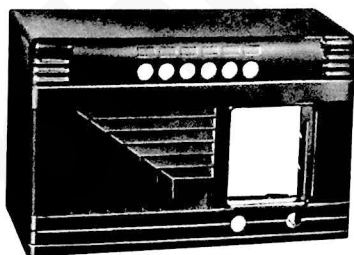

PT46

PHILCO RADIO CABINETS

Philco radio cabinets are exact replacements for the Philco table-model radios listed below.

These cabinets are finely constructed of the highest-quality bakelite, or of carefully selected woods, kiln-dried and beautifully finished in brown veneer effect.

The control holes have standard dimensions and spacing for convenient modernizing of older midget radios.

PART NO.	PHILCO MODEL	DESCRIPTION	LIST PRICE
10478B	41-90CB	Bakelite	\$4.65
10593A	43-131T	Wood	6.65
10524P	46-250 & PT2	Bakelite	3.75
10455A	PT25	Bakelite	1.50
10457A	PT46	Bakelite	2.50
10542D	46-200 & PT91	Bakelite	2.95

CABINET FEET



For use on radio cabinets, amplifiers, and similar items. The assortment contains two sizes of rubber feet complete with wood screws.

PART NO.	DESCRIPTION	LIST PRICE
45-9095	Approximately 10 assorted rubber feet	\$.40
45-9095-20	Standard carton of 20 packages No. 45-9095	\$8.00
45-9100	Approximately 10 rubber tack feet	.40
45-9100-20	Standard carton of 20 packages No. 45-9100	\$8.00
45-9105	Approximately 50 green felt discs, 3/4" diameter	.40
45-9105-20	Standard carton of 20 packages No. 45-9105	\$8.00



GENERAL-REPLACEMENT KNOBS



27-4604



27-4332



54-4052



54-4115



27-4809



27-4876



27-4820



54-4105



27-4309



77-0654



27-4326

For universal application in all table and console models. Finely polished, brown plastic. Molded in graceful, recessed designs.

Excellent for matching original knobs or for replacement of complete set. Spring push-on type. Available in a wide choice of modern styles.

PART NO.	DIAMETER IN INCHES	LIST PRICE
For 1/4" Shafts with Quarter-Diameter Reduction at Flat		
27-4604	1	\$0.15
27-4332	1 1/8	.15
For 1/4" Shafts with Half-Diameter Reduction at Flat		
54-4052	1	.20
27-4809	3/4	.15
54-4115	1 1/8	.20
27-4876	7/8	.20
27-4820	3/4	.15
54-4105	1	.20
For 1/4" Slotted Shaft		
27-4309	1 1/8	.35
77-0654	3/4 (Cream)	.20
27-4326	1 1/2	.15

VERNIER-DRIVE KNOBS



INNER
27-4331



OUTER
27-4330

Brown, molded plastic, for use on home and auto radios. Highly polished for beautiful, smooth appearance, with knurled edges for positive control. Designed for standard vernier-drive shafts. Spring push-on type.

PART NO.	KNOB DIAMETER IN INCHES	LIST PRICE
INNER		
27-4331	1 1/8	\$0.20
OUTER		
27-4330	1 3/8	.20

PUSH-BUTTON KNOBS

A wide variety of beautiful styles, for matching original knobs or for replacing entire set on home or auto push-button radios.

Finely polished plastic. Spring push-on type.



54-4144



54-4106



27-4824



55-0165



54-4009

PART NO.	COLOR	LIST PRICE
54-4144	Brown	\$0.15
54-4106	Brown	.15
27-4824	Mahogany	.15
55-0165	Tan	.15
54-4009	Walnut	.15

KNOB KIT

For replacement on Philco 1948-model universal auto radios. Supplied only in kit form for maximum convenience to distributors, dealers, and servicemen. Assorted colors. Spring push-on type.

PART NO.
45-1503

List Price
\$10.00



Contents of Kit:*

PART NO.	QUANTITY	ITEM	LIST PRICE
55-1278	8	Knob	\$0.20
55-0975	17	Knob	.20
55-1472	5	Knob	.20
54-4369	5	Knob	.20
55-0926	15	Knob	.20
57-1422FAB	50	Sleeve	.08

*For reference. Sold only in kit form.



LIST PRICE
85c
EACH

PHILCO LINE CORDS

Approved by Fire Underwriters and used by Philco in radios, television sets, and test equipment, Philco line cords are now offered for use in your shop. They are uniformly dependable units for many replacement and original-installation purposes.

At one end of the cord the conductors are bared and tinned, for convenient installation, and at the other end they are securely fastened to a rubber plug.

Supplied in black or brown, and in a variety of lengths, these cords will find many uses in the shop. The tough rubber insulation resists fraying and rubbing, and the stranded conductors provide excellent flexibility.

Philco line cords are underwriter-approved.

- UL approved
- Variety of lengths
- Equipped with rubber plug
- Rubber insulation
- Ideal for replacement uses
- Supplied in black or brown
- For dependable use with:
 - Test equipment
 - Radio
 - Television

PART NO.	LENGTH IN INCHES	COLOR	PART NO.	LENGTH IN INCHES	COLOR
L2183	102	Brown	41-3755-10	90	Black
L3183-1	78	Black	41-3755-11	92	Black
L3274	108	Brown	41-3755-12	105	Brown
L3337	76	Black	41-3755-13	76	Brown
L3339	78	Brown	41-3755-16	75	Brown
L3351	108	Brown	41-3755-17	82	Brown
L3356	102	Brown	41-3755-19	81	Brown
L3363	77	Brown	41-3821-6	72	Brown

SELENIUM PHOTO CELL



ACTUAL SIZE

The Philco photo cell, which contains the highest-grade selenium, is excellent for industrial applications and many uses in hobby work.

When one cell is placed two feet from an ordinary 50-watt bulb, the output is approximately 30 microamperes; this output is sufficient to drive a vacuum-

tube amplifier, which, in turn, can operate a relay control or meter.

Small clips of phosphor bronze or similar material may be used to support the cell, and to make connection with the output contacts.

For light-intensity measurements, four or more cells in series may be connected directly across a microammeter.

PART NO. LIST PRICE
56-1883 \$3.00

SELENIUM RECTIFIER



Philco's new selenium rectifier is designed as a quick, efficient replacement for the rectifier tube in AC/DC or AC/DC/BATTERY radios.

Designed to rugged specifications, the Philco selenium rectifier features convenient single-stud mounting, clear terminal markings, and instant rectification for quick set warm-up.

Operates at 120 volts, RMS max.; d-c output 100 ma., with only 5 volts drop. For voltage-doubler circuits two units are used. Size: 1 1/4" x 5/8" x 1 1/8".

Complete instructions and conversion schematics are included with each unit.

PART NO. LIST PRICE
34-8003-1 \$1.65

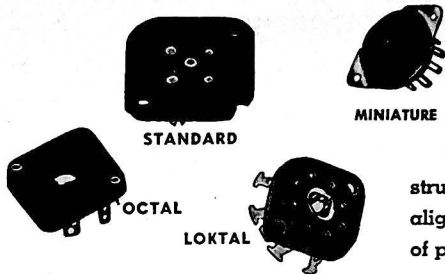

TUBE SOCKETS

Made of the finest laminated bakelite, these wafer sockets are constructed for secure tube mounting and positive contact. The full-floating, self-aligning lugs are tinned for easily soldered connections with minimum danger of poor joints.

STANDARD

OCTAL

LOKTAL

MINIATURE

PART NO.	PRONGS	LIST PRICE	PART NO.	PRONGS	LIST PRICE	PART NO.	PRONGS	LIST PRICE	PART NO.	PRONGS	LIST PRICE
27-6153	4	\$0.10	27-6058	8	\$0.15	27-6128	8	\$0.20	27-6203-1	7	\$0.25
27-6167	5	.15	27-6156	8	.15	27-6138	8	.15	27-6203-6	9	.50
27-6168	6	.15							27-6211-1	7	.35
									27-6226	7	.25

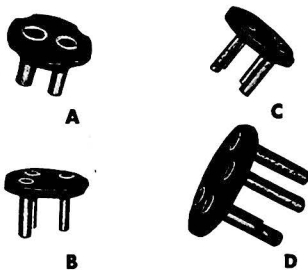

BATTERY PLUGS

For replacement on all farm and portable radios, Philco battery plugs are made of strong sheet bakelite, with plated prongs for positive, trouble-free connections.

The special rivet construction for securing the prongs to the insulation insures a sturdy unit and makes these plugs especially desirable for portable radio use.

FIG.	PART NO.	PRONGS	BATTERY TYPE	PHILCO BATTERY	LIST PRICE	FIG.	PART NO.	PRONGS	BATTERY TYPE	PHILCO BATTERY	LIST PRICE
A	27-4786	2	1½ v. "A"	P94, P816	\$0.15	C	27-4927	4	1½ v & 90 v. "A-B"	P60A-110	\$0.15
B	27-4787	3	45 v. "B"	P305, P602	.15	D	217-1057	4	1½ v & 90 v (for farm sets)	P60D11L	.15
C	27-4788	4	1½ v & 61½ v. "A-B"	P41A-4FL	.10	D	217-1260	5	7½ v & 90 v. "A-B"	P87	.15



MALE CONNECTORS

SPEAKER CONNECTORS

Philco male and female speaker connectors are made of high-grade black molded bakelite. They are sturdily constructed to withstand excess heat and strain, and they are designed for ease in the soldering of leads.

FEMALE CONNECTORS

PART NO.	CONTACTS	LIST PRICE	PART NO.	CONTACTS	LIST PRICE
27-4410	3	\$0.15	*27-4419-2	5	.20
217-1396	4	.20			
27-4412	5	.15			

*Substitutes for Female Connectors with 3 and 4 Contacts.

COMPRESSOR-SHAFT SEALS FOR REFRIGERATORS AND AIR CONDITIONERS

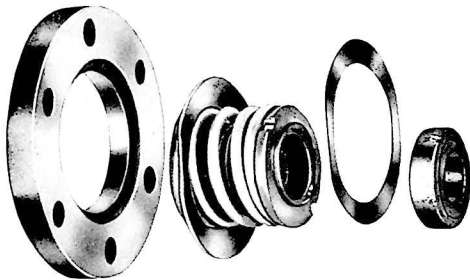

The refrigerator-shaft seals are for open-unit models, which are listed below, and in many cases may be used on other makes.

Part No. 8040-41 is designed for use only in either of the newly designed Philco Compressors, Model R-LG2 and Model R-LG3.

Model R-LG2 is used in Philco Air Conditioners, Models 61-C, CA, CL; 76-C, CA, CL; and 91-C and 91-CA. It is also the model furnished as a compressor replacement for use in Models 61-A and 61-B.

Model R-LG3 is used in Philco Air Conditioner, Model 101-C (water-cooled). It is also the model furnished as a compressor replacement for use in Models 76-A, 91-A, 76-B, and 91-B.

PART NUMBER	DESCRIPTION	LIST PRICE
8043-1	Fairbanks-Morse Model B.	\$4.40
8043-2	Fairbanks-Morse Models A, D, C.	3.70
6500-5	Philco-Conservador Model E.	7.50
8040-41	"C"-Series Air Conditioners.	8.00

PHILCO UNIVERSAL SHELF STUDS

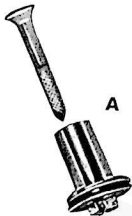

Philco universal shelf studs replace studs in any refrigerator, instantly and conveniently. It is not necessary to remove the food liner or breaker strips; therefore, a clean, simple replacement, without damage to any parts of the refrigerator, may be made. Chrome-plated brass with 1/4" stud mounting.



PART NUMBER	DIMENSIONS IN INCHES		FIGURE	LIST PRICE
	LENGTH	DIAMETER		
6031-13	1 1/2	3/8	A	\$.15
6031-21	5/16	3/8	A	.14
8622-4	(Nail used with above studs)			.06
6031-26	3/4	.7/32	B	.06
6031-27	1/2	.7/32	B	.06
6031-31	5/8	.7/32	B	.12
8622-6	(Nail used with above studs)			.06
6031-10	3/4	3/8	B	5.00/C
6031-20	3/4	3/8	B	.08
8622-1	(Nail used with above studs)			2.60/C

ANTI-ROCK BUMPER FOR ALL REFRIGERATORS

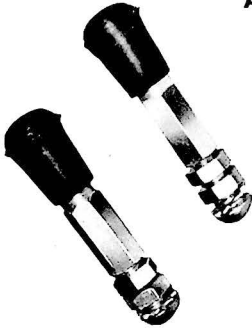

Philco anti-rock bumpers are designed to protect refrigerator and wall from damage while refrigerator is moved or door slammed and to prevent the rumbling and motion of refrigerator bodies.

A special feature enables Philco anti-rock bumpers to be used universally with any refrigerator, regardless of make or model.

Made of the finest materials, for shock-absorbency and sturdy construction, these units assist quiet and steady operation.

Excellent for use on refrigerators which have been in use for a long period of time, and have developed unsteady movement.

PART NUMBER
8040-33
(Kit of 2)

LIST PRICE
\$1.50

PHILCO INSULATION MATERIAL



Philco insulation is made of fiberglass or mineral wool, and is especially designed for padding in refrigerators and freezers.

Supplied in slabs of $38\frac{1}{2}'' \times 26\frac{3}{8}'' \times 3\frac{1}{8}''$, for convenient replacement of insulation damaged during the removal of the door latch, the temperature control, or panel sections.

PART NUMBER
6005-203
LIST PRICE
\$2.00

PHILCO WHITE LACQUER



Philco white lacquer, for retouching or refinishing refrigerators, is supplied in a handy container.

Made of the finest spirit varnishes, Philco white lacquer produces a beautiful luster and prevents oxidation of the refrigerator body. Makes used refrigerators look like new. Supplied in 1-qt. can.

PART NUMBER
8901-18

LIST PRICE
\$3.60

PHILCO THINNER



Philco thinner is prepared especially for use with Philco white lacquer.

Lustrous and durable coatings are easily applied to refrigerator bodies by the use of these Philco products.

Special ingredients in Philco thinner assist in obtaining a perfect "mix" with Philco white lacquer for the proper consistency. Supplied in 1-qt. can.

PART NUMBER
8901-37

LIST PRICE
\$2.20



PHILCO QUICK-RELEASE ICE-CUBE TRAY

Here is the modern refrigerator convenience millions now want—millions who own pre-war electric refrigerators equipped with old-style trays. Makes an ideal replacement for trays that must be held under water to loosen the cubes, or which have out-dated, lifeless rubber grids, hard to use and notoriously slow to freeze ice cubes.

The new Philco quick-release ice-cube tray appeals to every housewife. It's easy to sell several trays at a time, by showing how the lever instantly releases all cubes at once. No melting of ice under water . . . no difficulty in removing cubes.

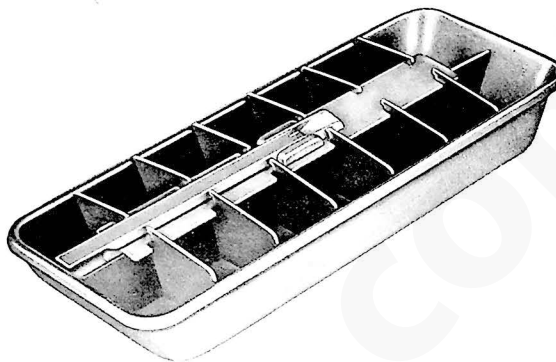

PART NO.
5520-8

LIST PRICE
\$2.25

PHILCO REFRIGERATOR CLEANER AND POLISH



A specially formulated cleaner and polish for the outside finish of refrigerators. An application covers the surface with a protective wax coating. Gives the refrigerator a clean, lustrous appearance. Makes "kitchen film" easy to rub off. Helps maintain that new spic-and-span look.

PART NUMBER
8020-3

LIST PRICE
50c

PHILCO POWER CABLES FOR AIR CONDITIONERS



Philco power cables are laboratory-approved for connecting air conditioners to the power source. Supplied in 100-foot lengths of two conductor or three-conductor cable. Philco power cables are ruggedly constructed of No. 14-gauge wire embedded in tough, brown-plastic insulation.

PART NO.	ITEM	LIST PRICE
45-1500	2-conductor cable (100 ft.)	\$40.00
45-1501	3-conductor cable (100 ft.)	50.00



PHILCO AIR CONDITIONING

PHILCO FILTERS FOR AIR CONDITIONERS

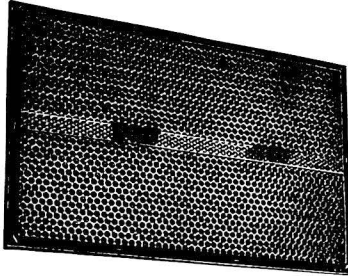

Philco air-conditioner filters are made under the famous Philco system of quality control; thus the finest materials and workmanship are insured.

These filters, designed for Philco air conditioners, provide pure air, free from dust and irritating particles. Hay-fever sufferers are greatly benefited by the use of the filter designed especially for them.

A clean filter will improve the operation of an air conditioner. Replace filters regularly.

PART NO.	SIZE	USED IN PHILCO MODEL	LIST PRICE
2701-1	15 ³ / ₁₆ " x 6 ¹ / ₄ " x 1 ¹ / ₂ "	A8, A9	\$2.50
P12502	14 ⁷ / ₈ " x 8 ³ / ₄ " x 1 ¹ / ₂ "	CW40, CW41	1.80
P10155	8 ⁷ / ₈ " x 12 ¹ / ₄ " x 1 ¹ / ₂ "	CW60	2.50
P14749	20" x 12 ¹ / ₂ " x 1 ¹ / ₂ "	CW61	2.20
P15523	13 ¹ / ₂ " x 10 ¹ / ₄ " x 1 ¹ / ₂ "	CW62	2.20
P17477	10" x 12" x 1 ¹ / ₂ "	61A, 76A, 91A, 101A	1.80
P12674	12 ³ / ₄ " x 13" x 1"	BA75	3.60
	(Special bronze)		
P12675	4 ¹ / ₈ " x 7" x 1"	BA75	2.20
	(Special bronze)		
P12676	12 ¹ / ₂ " x 14" x 1"	BA80, BA100	3.70
P12677	3 ³ / ₄ " x 8 ³ / ₄ " x 1"	BA80, BA100	2.20
P12678	6 ¹ / ₂ " x 6 ¹ / ₂ " x 1"	BA85	1.80
SP4513	13" x 14 ³ / ₄ "	BA85	6.00
P5897	7 ¹ / ₂ " x 34 ³ / ₄ " x 1"	CW90, CW100	2.70
P14739	22" x 11 ¹ / ₂ " x 1 ¹ / ₂ "	CW91, CW101	2.50
P22957	Hay Fever	61B, 76B, 91A, 91B	2.60
P203199	10" x 12" x 5 ⁸ / ₁₆ " (Pad only)	61C, 76C, 91C, 101C	1.00
P204056	10" x 12" x 5 ⁸ / ₁₆ "	61CA, 76CA, 91CA	2.00

WINDOW SILENCER

Windows in which air conditioners are installed have a tendency to amplify the slight vibration of an air-conditioner motor.

The Philco window silencer prevents window vibration when it is inserted between the sash and the molding. Made of curved spring steel, 3" x 1¹/₂".

PART NO.
ISD-432

LIST PRICE
.22

WINDOW LOCK

A slight pressure on the handle will lock the window in any partly raised position. When so locked it is impossible to move the window from outside.

The Philco window lock is made of lacquered brass, and is recommended especially for windows in which air conditioners are installed.



PART NO. LIST PRICE
ISD-379 \$1.20

REPLACEMENT PARTS LISTING BY MODEL NUMBER TELEVISION MODELS

MODEL	CODE	POWER TRANSFORMER	AUDIO- OUTPUT TRANSFORMER	SPEAKER	VOLUME CONTROL	TONE CONTROL	CONTRAST CONTROL	BACKGROUND CONTROL	VERTICAL-HOLD CONTROL	HORIZONTAL- HOLD CONTROL	FOCUS CONTROL
48-700	121	32-8364	32-8244-2	36-1613-1	33-5538-12	None	33-5546-7	33-5548	33-5539-15	33-5539-28	33-5548-1
48-1000	121	32-8303	32-8244-1	36-1613-2	33-5535-9	33-5538-9	33-5546-6	33-5539-17	33-5539-15	33-5539-13	33-5546-5
	122	32-8303	32-8244-1	36-1613-2	33-5535-9	33-5538-9	33-5546-6	33-5539-17	33-5539-15	33-5539-28	33-5547-2
	122 (50-cycle)	32-8344	32-8244-1	36-1613-2	33-5535-9	33-5538-9	33-5546-6	33-5539-17	33-5539-15	33-5539-28	33-5547-2
	125	32-8303	32-8244-1	36-1613-2	33-5535-9	33-5538-9	33-5546-6	33-5539-17	33-5539-15	33-5539-28	33-5547-2
48-1001	121	32-8303	32-8244-1	36-1613-2	33-5535-9	33-5538-31	33-5546-6	33-5539-17	33-5539-15	33-5539-28	33-5546-12
	121 (50-cycle)	32-8344	32-8244-1	36-1613-2	33-5535-9	33-5538-31	33-5546-6	33-5539-17	33-5539-15	33-5539-28	33-5546-12
	122	32-8303	32-8244-1	36-1613-2	33-5535-9	33-5538-31	33-5546-6	33-5539-17	33-5539-15	33-5539-28	33-5546-12
	122 (50-cycle)	32-8344	32-8244-1	36-1613-2	33-5535-9	33-5538-31	33-5546-6	33-5539-17	33-5539-15	33-5539-28	33-5546-12
48-1050	122	32-8303	32-8244-1	36-1613-2	33-5535-9	33-5538-9	33-5546-6	33-5539-17	33-5539-15	33-5539-28	33-5547-2
	122 (50-cycle)	32-8344	32-8244-1	36-1613-2	33-5535-9	33-5538-9	33-5546-6	33-5539-17	33-5539-15	33-5539-28	33-5547-2

*Order by Model and Code Numbers. Substitute will be supplied.

REPLACEMENT PARTS LISTING BY MODEL NUMBER
TELEVISION MODELS

FILTER CONDENSER	AUDIO DISCRIMINATOR TRANSFORMER	SOUND I-F TRANSFORMER			VIDEO I-F TRANSFORMERS			VERTICAL- SWEEP- GENERATOR TRANS- FORMER	VERTICAL- SWEEP- OUTPUT TRANS- FORMER	HORIZON- TAL-SWEEP- GENERATOR TRANS- FORMER	HORIZON- TAL-SWEEP- OUTPUT TRANS- FORMER
		1st	2nd	INPUT	1st	2nd	3rd				
30-20-20 mfd—450v 30 mfd—475v	32-4214-1	32-4100	32-4099	32-4093	32-4213	32-4213-1	32-4093-3	32-8304	None	32-8307	None
20-40-10 mfd—475v 10 mfd— 25v 30 mfd—475v 50 mfd— 25v	32-4214	32-4100	32-4099	32-4093	32-4213	32-4213-1	32-4093-1	32-8304	32-8306	32-8307	32-8331
20-40-10 mfd—475v 10 mfd— 25v 30 mfd—475v 50 mfd— 25v	32-4214	32-4100	32-4099	32-4213	32-4213-1	32-4093-3	32-4093-1	32-8304	32-8306	32-8307	32-8331
20-40-10 mfd—475v 10 mfd— 25v 30 mfd—475v 50 mfd— 25v	32-4214	32-4100	32-4099	32-4093	32-4213	32-4213-1	32-4093-1	32-8304	32-8306	32-8307	32-8331
20-40-10 mfd—475v 10 mfd— 25v 30 mfd—475v 50 mfd— 25v	32-4214	32-4100	32-4099	32-4093	32-4213	32-4213-1	32-4093-1	32-8304	32-8306	32-8307	32-8331
50 mfd— 25v 30 mfd—475v 40-10-20 mfd—475v 10 mfd— 25v	32-4214	32-4100	32-4099	32-4093	32-4213	32-4213-1	32-4093-1	32-8304	32-8306	32-8307	32-8331
50 mfd— 25v 30 mfd—475v 40-10-20 mfd—475v 10 mfd— 25v	32-4214	32-4100	32-4099	32-4093	32-4213	32-4213-1	32-4093-1	32-8304	32-8306	32-8307	32-8331
30 mfd—475v 40-10-20 mfd—475v 10 mfd— 25v	32-4317-1	32-4100	32-4099	32-4093	32-4213	32-4213-1	32-4093-1	32-8304	32-8306	32-8307	32-8331
30 mfd—475v 40-10-20 mfd—475v 10 mfd— 25v	32-4317-1	32-4100	32-4099	32-4093	32-4213	32-4213-1	32-4093-1	32-8304	32-8306	32-8307	32-8331
20-40-10 mfd—475v 10 mfd— 25v 30 mfd—475v 50 mfd— 25v	32-4214	32-4100	32-4099	32-4093	32-4213	32-4213-1	32-4093-1	32-8304	32-8306	32-8307	32-8331
20-40-10 mfd—475v 10 mfd— 25v 30 mfd—475v 50 mfd— 25v	32-4214	32-4100	32-4099	32-4093	32-4213	32-4213-1	32-4093-1	32-8304	32-8306	32-8307	32-8331

*Order by Model and Code Numbers. Substitute will be supplied.



REPLACEMENT PARTS LISTING BY MODEL NUMBER TELEVISION MODELS — (Cont.)

MODEL	CODE	POWER TRANSFORMER	AUDIO-OUTPUT TRANSFORMER	SPEAKER	VOLUME CONTROL	STONE CONTROL	CONTRAST CONTROL	BACKGROUND CONTROL	VERTICAL-HOLD CONTROL	HORIZONTAL-HOLD CONTROL	FOCUS CONTROL
48-2500	121	32-8303	32-8244-1	36-1610-1	33-5535-9	33-5538-9	33-5546-6	33-5539-17	33-5539-15	33-5539-13	33-5547-1
	122	32-8303	32-8244-1	36-1610-1	33-5535-9	33-5538-9	33-5546-6	33-5539-17	33-5539-15	33-5539-28	33-5547-2
	122 (50-cycle)	32-8344	32-8244-1	36-1610-1	33-5535-9	33-5538-9	33-5546-6	33-5539-17	33-5539-15	33-5539-28	33-5547-2
49-1075	121	32-8376	32-8356 (T) 32-8367-1 (R)	36-1610-2	33-5535-17 (R) 33-5564-1 (T)	33-5538-34 R	33-5546-11	33-5539-43	33-5563	33-5563	33-5546-13
	122	32-8376	32-8356 (T) 32-8367-1 (R)	36-1610-2	33-5535-17 (R) 33-5564-1 (T)	33-5538-34 R	33-5546-11	33-5539-43	33-5563	33-5563	33-5546-13
	122 (50 cycle)	32-8357-2	32-8356 (T) 32-8367-1 (R)	36-1610-2	33-5535-17 (R) 33-5564-1 (T)	33-5538-34 R	33-5546-11	33-5539-43	33-5563	33-5563	33-5546-13
	123	32-8376	32-8356 (T) 32-8367-1 (R)	36-1610-2	33-5535-17 (R) 33-5564-1 (T)	33-5538-34 R	33-5546-11	33-5539-43	33-5563	33-5563	33-5546-13
49-1076	122	32-8376	32-8367-1 (R) 32-8356 (T)	36-1610-2	33-5535-17 (R) 33-5564-1 (T)	33-5538-34 R	33-5546-11	33-5539-43	33-5563	33-5563	33-5546-13
	123	32-8376	32-8367-1 (R) 32-8356 (T)	36-1610-2	33-5535-1 (R) 33-5564-1 (T)	33-5538-34 R	33-5546-11	33-5539-43	33-5563-3	33-5563-3	33-5546-13

*Order by Model and Code Numbers. Substitute will be supplied.

REPLACEMENT PARTS LISTING BY MODEL NUMBER
TELEVISION MODELS—(Cont.)

FILTER CONDENSER	AUDIO DISCRIMINATOR TRANSFORMER	SOUND I-F TRANSFORMER			VIDEO I-F TRANSFORMERS			VERTICAL- SWEEP- GENERATOR TRANS- FORMER	VERTICAL- SWEEP- OUTPUT TRANS- FORMER	HORIZON- TAL SWEEP- GENERATOR TRANS- FORMER	HORIZON- TAL SWEEP- OUTPUT TRANS- FORMER
		1st	2nd	INPUT	1st	2nd	3rd				
20-40-10 mfd—475v 10 mfd— 25v 30 mfd—475v 50 mfd— 25v	32-4214	32-4100	32-4099	32-4093	32-4213	32-4213-1	32-4093-1	32-8304	32-8306	32-8307	32-8345-1
20-40-10 mfd—475v 10 mfd— 25v 30 mfd—475v 50 mfd— 25v	32-4214	32-4100	32-4099	32-4093	32-4213	32-4213-1	32-4093-1	32-8304	32-8306	32-8307	32-8345-1
20-40-10 mfd—475v 10 mfd— 25v 30 mfd—475v 50 mfd— 25v	32-4214	32-4100	32-4099	32-4093	32-4213	32-4213-1	32-4093-1	32-8304	32-8306	32-8307	32-8345-1
Radio 40-40-20-10 mfd—250v	32-4317	32-4303	32-4236	—	32-4302	32-4234-1	— ‡	32-8304-3	32-8306-1	32-8307-2	32-8331
Television 10-10-10-10 mfd—475v 10-10 mfd—450v 40 mfd— 50v											
Radio 40-40-20-10 mfd—250v	32-4317	32-4303	32-4236	—	32-4302	32-4234-1	— ‡	32-8304-3	32-8306-1	32-8307-2	32-8331
Television 10-10-10-10 mfd—475v 10-10 mfd—450v 40 mfd— 50v											
Radio 40-40-20-10 mfd—250v	32-4317	32-4303	32-4236	—	32-4302	32-4234-1	— ‡	32-8304-3	32-8306-1	32-8307-2	32-8331
Television 10-10-10-10 mfd—475v 10-10 mfd—450v 40 mfd— 50v											
Radio 40-40-20-10 mfd—250v	32-4317	32-4303	32-4236	—	32-4302	32-4234-1	— ‡	32-8304-3	32-8306-1	32-8307-2	32-8331
Television 10-10-10-10 mfd—475v 10-10 mfd—450v 40 mfd— 50v											
Radio 40-40-20-10 mfd—250v	32-4317	32-4303	32-4236	—	32-4302	32-4234-1	— ‡	32-8304-3	32-8306-1	32-8307-2	32-8331
Television 10-10-10-10 mfd—475v 10-10 mfd—450v 40 mfd— 50v											
Radio 40-40-20-10 mfd—250v	32-4317	32-4303	32-4236	—	32-4302	32-4234-1	— ‡	32-8304-3	32-8306-1	32-4367	32-8331
Television 10-10-10-10 mfd—475v 10-10 mfd—450v 40 mfd— 50v											

*Order by Model and Code Numbers. Substitute will be supplied.

‡For Radio IF Transformer See Bottom of Page 132.

REPLACEMENT PARTS LISTING BY MODEL NUMBER
TELEVISION MODELS—(Cont.)

FILTER CONDENSER	AUDIO DISCRIMINATOR TRANSFORMER	AUDIO I-F TRANSFORMER			VIDEO I-F TRANSFORMERS			VERTICAL- SWEEP- GENERATOR TRANS- FORMER	VERTICAL- SWEEP- OUTPUT TRANS- FORMER	HORIZON- TAL SWEEP- OUTPUT TRANS- FORMER	HORIZON- TAL SWEEP- TRANS- FORMER GENERATOR
		1st	2nd	INPUT	1st	2nd	3rd				
40-10-20 mfd—475v 10 mfd— 25v 30 mfd—475v 30 mfd—250v	32-4317	32-4303	32-4236	—	32-4302	32-4234-1	—	32-8304-3	32-8306-1	32-8307-2	32-8358
40-10-20 mfd—475v 10 mfd— 25v 30 mfd—475v 30 mfd—250v	32-4317	32-4303	32-4236	—	32-4302	32-4234-1	—	32-8304-3	32-8306-1	32-8307-2	32-8358
40-20-10 mfd—475v 10 mfd— 25v 30 mfd—475v 30 mfd—250v	32-4317	32-4303	32-4236	—	32-4302	32-4234-1	—	32-8304-3	32-8306-1	32-8307-2	32-8358
40-20-10 mfd—475v 10 mfd— 25v 30 mfd—475v 30 mfd—250v	32-4317	32-4303	32-4236	—	32-4302	32-4234-1	—	32-8304-3	32-8306-1	32-8307-2	32-8358
Radio 40-40-20-10 mfd—250v Television	32-4317	32-4303	32-4236	—	32-4302	32-4234-1	— ‡	32-8304-3	32-8306-1	32-8307-2	32-8331
10-10-10-10 mfd—475v 10-10 mfd—450v 40 mfd— 50v											
Radio 40-40-20-10 mfd—250v Television	32-4317	32-4303	32-4236	—	32-4302	32-4234-1	— ‡	32-8304-3	32-8306-1	32-8307-2	32-8331
10-10-10-10 mfd—475v 10-10 mfd—450v 40 mfd— 50v											
Radio 40-40-20-10 mfd—250v Television	32-4317	32-4303	32-4236	—	32-4302	32-4234-1	— ‡	32-8304-3	32-8306-1	32-8307-2	32-8331
10-10-10-10 mfd—475v 10-10 mfd—450v 40 mfd— 50v											
Radio 40-40-20-10 mfd—250v Television	32-4317	32-4303	32-4236	—	32-4302	32-4234-1	— ‡	32-8304-3	32-8306-1	32-4367	32-8331
10-10-10-10 mfd—475v 10-10 mfd—450v 40 mfd— 50v											
Radio 40-40-20-10 mfd—250v	32-4317	32-4303	32-4236	—	32-4302	32-4234-1	— ‡	32-8304-3	32-8306-1	32-8307-2	32-8358

* Order by Model and Code Numbers. Substitute will be supplied.
‡ For Radio IF Transformer See Bottom of Page 133.

RADIO IF TRANSFORMERS

MODEL	CODE	1st	2nd	3rd
49-1275	121	32-4258 (AM)	32-4257-1 (FM)	32-4261-1 (FM)
		32-4257 (FM)	32-4160-3 (AM)	32-4240-2 (AM)
	121 (50-cycle)	32-4258 (AM)	32-4257-1 (FM)	32-4261-1 (FM)
		32-4257 (FM)	32-4160-3 (AM)	32-4240-2 (AM)
	123	32-4258 (AM)	32-4257-1 (FM)	32-4261-1 (FM)
		32-4257 (FM)	32-4160-2 (AM)	32-4240-2 (AM)
49-1278	122	32-4258 (AM)	32-4257-1 (FM)	32-4261-1 (FM)
		32-4257 (FM)	32-4160-3 (AM)	32-4240-2 (AM)
	123	32-4258 (AM)	32-4257-1 (FM)	32-4261-1 (FM)
		32-4257 (FM)	32-4160-3 (AM)	32-4240-2 (AM)



REPLACEMENT PARTS LISTING BY PHILCO MODEL NUMBER

This replacement parts listing organizes, in convenient form, certain major parts in Philco radio and television sets.

Divided into two sections for quick location of model and code number, the sections are headed:

- HOME-RADIO MODELS
- AUTO-RADIO MODELS

HOME-RADIO MODELS

MODEL	CODE	POWER TRANSFORMER	OUTPUT TRANSFORMER	SPEAKER	VOLUME CONTROL	FILTER CONDENSER	I-F TRANSFORMER		
							1st	2nd	3rd
14	121	★	★	★	45-5011	6-6 mfd—475v	★	★	—
	122	32-7283	32-7078	★	45-5011	8-8 mfd—475v	★	★	—
	122L	32-7283	32-7078	★	45-5011	8-8 mfd—475v	★	★	—
	123	32-7283	32-7078	★	45-5011	8-8 mfd—475v 10 mfd—100v	★	★	—
	124	32-7283	32-7078	★	45-5011	8-8 mfd—475v 10 mfd—100v	★	★	—
	126	★	32-7078	★	45-5011	6-6 mfd—400v	★	★	—
	221	★	★	★	45-5011	8-8 mfd—475v	★	★	—
	222	★	32-7078	★	45-5011	8-8 mfd—475v 10 mfd—100v	★	★	—
	226	★	32-7078	★	45-5011	8-8 mfd—475v	★	★	—
15	121	★	★	★	45-5013	6-6 mfd—400v	★	★	—
	123	★	★	★	45-5011	6-6 mfd—400v	★	★	—
	126	★	★	★	45-5011	6-6 mfd—400v	★	★	—
	221	★	★	★	45-5013	6-6 mfd—400v	★	★	—
	223	★	★	★	45-5011	6-6 mfd—400v	★	★	—
	225	★	★	★	45-5011	6-6 mfd—400v	★	★	—
	226	★	★	★	45-5011	6-6 mfd—400v	★	★	—
16	121	★	32-7078	★	45-5008	8-8 mfd—450v 10 mfd— 50v	★	★	—
	122	★	32-7078	★	45-5008	8-8 mfd—500v 10 mfd— 50v	★	★	—
	123	★	32-7078	★	45-5008	8-8 mfd—500v 10 mfd— 50v	★	★	—
	125	★	32-7078	★	45-5008	8-8 mfd—475v 10 mfd— 50v	★	★	—
	126	32-7283	32-7078	★	45-5008	8-8 mfd—475v 10 mfd— 50v	★	★	—
	127	32-7283	32-7078	★	45-5008	8-8 mfd—475v 10 mfd— 50v	★	★	—
	17	121	★	32-7078	★	33-5023	8-8 mfd—475v 10 mfd— 50v	★	★
121LS		★	32-7078	★	33-5023	8-8 mfd—475v 10 mfd— 50v	★	★	—
122		★	32-7078	★	33-5023	8-8 mfd—475v 10 mfd— 50v	★	★	—
123		★	32-7078	★	33-5023	8-8 mfd—475v 10 mfd— 50v	★	★	—
18	121	32-7283	32-7078	★	45-5011	8-8 mfd—475v 10 mfd— 50v	32-1289	★	—
	122	32-7283	32-7078	★	45-5011	8-8 mfd—475v 10 mfd— 50v	32-1289	★	—
	123	32-7283	32-7078	★	45-5011	8-8 mfd—475v 10 mfd— 50v	32-1289	★	—
	124	32-7283	32-7078	★	45-5011	8-8 mfd—475v 10 mfd— 50v	32-1289	★	—

*Order by Model and Code Numbers. Substitute will be supplied.



REPLACEMENT PARTS LISTING—HOME RADIOS (Cont.)

MODEL	CODE	POWER TRANSFORMER	OUTPUT TRANSFORMER	SPEAKER	VOLUME CONTROL	FILTER CONDENSER	1st	I-F TRANSFORMER 2nd	3rd
19	121	32-7381	32-7065	★	45-5013	8-8 mfd—475v	★	★	—
	122	32-7381	32-7065	★	45-5013	8-8 mfd—475v	★	★	—
	123	32-7381	32-7065	★	45-5013	8-8 mfd—475v	★	★	—
	124-125	32-7381	32-7065	★	45-5013	8-8 mfd—475v	★	★	—
	126	32-7381	32-7065	★	45-5013	8-8 mfd—475v	★	★	—
	128	★	32-7286	★	45-5011	8-8 mfd—475v	32-1289	★	—
20	—	★	★	★	4094	★	★	★	—
21	—	6072	★	★	4094	★	★	★	—
22	121-125	★	32-7065	★	45-5012	8-8 mfd—475v	★	★	—
	221-225	★	★	★	45-5012	8-8 mfd—475v	★	★	—
23X	—	★	★	★	45-5012	8-8 mfd—500v	★	★	—
24	—	★	32-7567	★	45-5012	★	★	★	—
25	—	★	★	★	45-5012	6-6 mfd—450v	★	★	—
26	121	32-7381	32-7065	★	★	6-6 mfd—475v	★	★	—
27	121	32-7381	32-7065	★	45-5011	6-6 mfd—475v	★	★	—
	123	32-7381	32-7065	★	45-5011	8-6 mfd—475v	★	★	—
	126	32-7381	32-7065	★	45-5011	6-6 mfd—475v	★	★	—
28	121	AC-DC	32-7566	★	45-5011	16-8 mfd—150v	32-1671	★	★
	122	AC-DC	32-7566	★	45-5011	16-8 mfd—150v	32-1671	★	★
	124	AC-DC	★	★	45-5011	16-8 mfd—150v	32-1671	★	★
29	121	★	★	★	45-5011	8-8-10 mfd—450v/ 50v 6 mfd—475v	32-1671	★	★
	123	★	★	★	45-5011	8-8-10 mfd—450v/ 50v 6 mfd—475v	32-1671	★	★
	124	★	★	★	45-5011	8-8-10 mfd—450v/ 50v 6 mfd—475v	32-1671	★	★
30	—	Battery	—	★	45-5019	—	—	—	—
32	—	32-7218	32-7065	★	45-5011	8-8 mfd—500v	32-1289	★	—
34-34A	121	Battery	32-7286	★	★	★	★	★	★
	125	Battery	32-7286	★	★	★	★	★	★
35	—	Battery	32-7286	★	★	—	★	★	—
36	—	Battery	2646	★	★	—	★	★	—
37	—	Battery	★	★	7239	★	★	★	—

*Order by Model and Code Numbers. Substitute will be supplied.

PARTS LIST



Use Genuine
PHILCO
PARTS

REPLACEMENT PARTS LISTING—HOME RADIOS (Cont.)

MODEL	CODE	POWER TRANSFORMER	OUTPUT TRANSFORMER	SPEAKER	VOLUME CONTROL	FILTER CONDENSER	I-F TRANSFORMER		
							1st	2nd	3rd
38-38A	121	Battery	★	★	45-5020	★	★	★	—
	122	Battery	32-7286	★	45-5020	★	★	★	—
	123	Battery	32-7286	★	45-5020	★	★	★	—
39	—	Battery	32-7286	★	45-5020	★	★	★	—
40	—	—	★	★	4056	★	—	—	—
41	—	DC only	★	★	4056	★	—	—	—
42	—	—	★	★	45-5012	★	—	—	—
43	121	★	32-7065	★	45-5012	6-8 mfd—500v	★	★	—
	221	★	★	★	45-5012	6-8 mfd—500v	★	★	—
44	121	32-7381	32-7065	★	45-5013	6-8-8 mfd—475v	★	★	—
	122	32-7381	32-7065	★	45-5013	6-8-8 mfd—475v	★	★	—
45	121	★	32-7065	★	45-5011	6-8-8 mfd—475v	32-1671	★	★
	122	★	32-7567	★	45-5011	6-8-8 mfd—475v	32-1671	★	★
46	—	DC only	★	★	★	★	—	—	—
47	121	DC only	32-7078	★	45-5012	★	★	★	—
	123	DC only	32-7078	★	45-5012	★	★	★	—
	221	DC only	★	★	45-5012	★	★	★	—
	223	DC only	★	★	45-5012	★	★	★	—
	125	DC only	32-7078	★	45-5012	★	★	★	—
48	—	DC only	32-7567	★	45-5001	★	★	★	—
49	121	DC only	32-7078	★	45-5011	★	★	★	—
	321	DC only	32-7078	★	45-5011	★	★	★	—
50	—	★	32-7567	★	5232	6-6 mfd—475v	—	—	—
51-51A	121	★	32-7567	★	45-5001	6-6 mfd—475v	★	★	—
	123	★	32-7567	★	45-5001	6-6 mfd—475v	★	★	—
52	121	★	32-7567	★	45-5010	6-6 mfd—475v	★	★	—
	123	★	32-7567	★	45-5010	6-6 mfd—475v	★	★	—
53	—	AC-DC	★	★	45-5010	12-12 mfd—150v	★	—	—
54C-54S	—	AC-DC	32-7566	★	45-5013	12-12 mfd—150v	★	★	—
55A	—	★	32-7567	★	5232	★	★	★	—
55E	—	★	32-7567	★	5232	★	★	★	—
56	—	★	32-7567	★	5232	★	★	★	—
57	—	32-7552	32-7567	★	45-5010	8-4 mfd—450v	32-1155	—	—
58	—	32-7552	32-7567	★	45-5010	8-4 mfd—450v	32-1155	—	—

*Order by Model and Code Numbers. Substitute will be supplied.



REPLACEMENT PARTS LISTING—HOME RADIOS (Cont.)

MODEL	CODE	POWER TRANSFORMER	OUTPUT TRANSFORMER	SPEAKER	VOLUME CONTROL	FILTER CONDENSER	I-F TRANSFORMER		
							1st	2nd	3rd
59C	—	32-7552	32-7567	★	45-5010	8-4 mfd—450v	32-1155	—	—
59S	—	32-7552	32-7567	★	45-5010	8-4 mfd—450v	32-1155	—	—
60	—	32-7381	32-7567	★	45-5013	8-8 mfd—475v	32-1304	32-1305	—
65	—	★	32-7567	★	★	★	—	—	—
66	—	32-7381	32-7567	★	45-5013	8-8-6 mfd—475v	32-1414	★	—
70	—	6072	2646	★	45-5012	6-6 mfd—450v	★	★	—
71	121	6672	32-7065	★	45-5012	6-6 mfd—500v	★	★	—
	125	6672	32-7065	★	45-5012	6-6 mfd—500v	★	★	—
	221	6672	★	★	45-5012	8-8 mfd—475v	★	★	—
	225	6672	★	★	45-5012	8-8 mfd—475v	★	★	—
71H	—	★	★	★	★	8-8 mfd—475v	★	★	—
76	—	★	★	★	33-5060	★	—	—	—
77	—	★	★	★	4094	★	—	—	—
80	—	32-7180	32-7567	★	45-5010	8-4 mfd—475v 10 mfd— 25v	★	—	—
81	—	32-7180	32-7567	★	45-5010	8-4 mfd—475v	★	—	—
82	—	★	★	★	45-5002	★	—	—	—
83	—	★	★	★	45-5002	★	—	—	—
84	—	32-7180	32-7567	★	45-5010	4-8 mfd—450v	32-1155	—	—
86	—	★	★	★	45-5002	★	—	—	—
87	—	★	★	★	45-5002	★	—	—	—
89	121	32-7381	32-7065	★	45-5013	6-8 mfd—475v	★	★	—
	123	32-7381	32-7065	★	45-5013	8-8 mfd—450v	32-1289	★	—
	126	32-7381	32-7065	★	45-5013	6-8 mfd—475v	★	★	—
90	121								
	(2-45 tubes)	★	★	★	4094	6-6 mfd—450v	★	★	—
	(1-47 tube)	★	2646	★	45-5012	6-6 mfd—450v	★	★	—
	(2-47 tubes)	6072	★	★	45-5019	6-6 mfd—450v	★	★	—

*Order by Model and Code Numbers. Substitute will be supplied.



REPLACEMENT PARTS LISTING—HOME RADIOS (Cont.)

MODEL	CODE	POWER TRANSFORMER	OUTPUT TRANSFORMER	SPEAKER	VOLUME CONTROL	FILTER CONDENSER	1st	I-F TRANSFORMER 2nd	3rd
91	121	★	★	★	45-5012	6.6 mfd—450v 8 mfd—475v	★	★	—
	221	★	★	★	45-5012	8 mfd—475v 8 mfd—400v	★	★	—
	125	★	★	★	45-5012	6 mfd—450v 6 mfd—475v	★	★	—
	126	★	★	★	45-5011	8 mfd—475v	★	★	—
	225	★	★	★	45-5012	6.6 mfd—450v	★	★	—
	226	★	★	★	45-5011	8 mfd—475v	★	★	—
95	—	5594	★	★	45-5019	★	—	—	—
96	—	5594	★	★	45-5019	★	—	—	—
97X	—	★	★	★	45-5013	8-12 mfd—475v	★	32-1632	—
97B	—	★	★	★	45-5013	12.8 mfd—475v	★	32-1632	—
98X	—	★	★	★	45-5013	12.8 mfd—475v	★	32-1632	—
98B	—	★	★	★	45-5013	12.8 mfd—475v	★	32-1632	—
111	—	★	★	★	45-5019	★	★	★	—
112	2-45 tubes	★	★	★	45-5019	★	★	★	—
	2-47 tubes	5594	★	★	45-5019	6.6 mfd—475v	★	★	—
116	121	★	32-7078	★	45-5008	8.8 mfd—475v 10 mfd— 50v	32-1864	32-1865	32-1866
	122	32-7431	32-7461	★	33-5119	8.8 mfd—475v 10 mfd—100v	32-1864	32-1865	32-1866
118	121	32-7283	32-7078	★	45-5011	8.8 mfd—475v 10 mfd— 50v	★	32-1424	—
	123	32-7283	32-7078	★	45-5011	8.8 mfd—475v 10 mfd— 50v	★	32-1424	—
144	121	★	★	★	45-5011	8.8-6 mfd—475v 10 mfd— 50v	★	★	★
	125	★	★	★	45-5011	8.8-6 mfd—475v 10 mfd— 50v	★	★	★
200	—	32-7283	32-7905	★	33-5071	8.8 mfd—475v 10 mfd— 50v	★	32-1403	★
201	121	32-7283	32-7905	★	33-5071	8.8 mfd—475v 10 mfd— 50v	★	32-1483	★
211	—	★	★	★	45-5019	★	★	★	—

*Order by Model and Code Numbers. Substitute will be supplied.



REPLACEMENT PARTS LISTING—HOME RADIOS (Cont.)

MODEL	CODE	POWER TRANSFORMER	OUTPUT TRANSFORMER	SPEAKER	VOLUME CONTROL	FILTER CONDENSER	I-F TRANSFORMER		
							1st	2nd	3rd
212	2-45 tubes	★	★	★	45-5019	★	★	★	—
	2-47 tubes	5594	★	★	45-5019	6-6 mfd—475v	★	★	—
220	—	★	★	★	4094	★	—	—	—
270	—	★	2646	★	45-5012	6-6 mfd—450v	★	★	—
296	—	5594	★	★	45-5019	★	—	—	—
370	—	★	2646	★	4094	6-6 mfd—450v	★	★	—
470	—	★	2646	★	4094	6-6 mfd—450v	★	★	—
490	—	★	★	★	45-5019	6-6 mfd—450v	★	★	—
500	121	★	32-7078	★	33-5119	8-8 mfd—475v 10 mfd— 50v	★	★	—
	122	★	32-7078	★	33-5119	8-8 mfd—475v 10 mfd— 50v			
501	—	★	32-7078	★	33-5119	8-8 mfd—500v 10 mfd— 50v	★	★	—
503	121	32-7283	32-7078	★	45-5011	8-8 mfd—450v 10 mfd— 50v	32-1289	32-1258	—
	122	32-7283	32-7078	★	45-5011	8-8 mfd—450v 10 mfd— 50v	32-1289	32-1258	—
504	—	32-7381	32-7065	★	45-5013	8-8 mfd—475v	★	32-1306	—
505	—	32-7381	32-7065	★	45-5013	8-8 mfd—475v	32-1304	★	—
506	—	★	32-7256	★	45-5011	6-8-8 mfd—475v 10 mfd— 50v	★	★	★
507	—	32-7283	32-7078	★	45-5011	8-8 mfd—475v 10 mfd— 50v	★	★	—
509	—	32-7283	32-7905	★	33-5071	8-8 mfd—475v 10 mfd— 50v	★	★	★
511	—	★	—	★	45-5002	★	—	—	—
551	—	★	32-7567	★	45-5001	★	★	★	—

*Order by Model and Code Numbers. Substitute will be supplied.

PARTS LIST



Use Genuine
PHILCO
PARTS

REPLACEMENT PARTS LISTING—HOME RADIOS (Cont.)

MODEL	CODE	POWER TRANSFORMER	OUTPUT TRANSFORMER	SPEAKER	VOLUME CONTROL	FILTER CONDENSER	1st	I-F TRANSFORMER 2nd	3rd
570	—	★	2646	★	4094	6-6 mfd—475v	★	★	—
600	—	32-7552	32-7567	★	33-5152	4-8 mfd—475v	★	—	—
602	—	AC-DC	32-7566	★	33-5276	16-16 mfd—150v	32-2005	32-2006	—
604	—	AC-DC	32-7566	★	45-2381	8-16-16 mfd—150v	32-2672	32-2006	—
610	T	32-7381	32-7567	★	45-5019	8-8 mfd—475v	32-1671	32-1672	—
	F	32-7381	32-7567	★	45-5019	8-8 mfd—475v	32-1671	32-1672	—
	PF	32-7381	32-7065	★	45-5019	8-8 mfd—475v	32-1671	32-1672	—
611	—	AC-DC	★	★	45-5019	16-16 mfd—150v 10 mfd—150v	32-1671	32-1672	—
620	—	32-7381	32-7567	★	45-5008	8-8 mfd—475v 16 mfd—400v	32-1646	32-1647	—
623	121	Battery	★	★	45-5020	2-4 mfd—150v 8 mfd—100v	32-1671	32-1672	—
624	121	32-7504	32-7639	★	33-5137	8-8-25-8 mfd—150v	32-1671	32-1672	—
625	121	32-7381	32-7567	★	45-5008	16 mfd—400v 8-8 mfd—475 v	★	32-2020	—
630	121	★	★	★	45-5008	16 mfd—400v 8-8 mfd—475v 10 mfd— 50v	★	★	—
630PF	—	★	★	★	45-5008	16 mfd—400v 8-8 mfd—475v 10 mfd— 50v	★	★	—
635	121	★	★	★	45-5008	8-8 mfd—475v 10 mfd— 50v 16 mfd—350v	★	★	—
	124	★	★	★	45-5008	8-8 mfd—475v 10 mfd— 50v 16 mfd—350v	★	★	—
640	121	★	★	★	45-5008	12-8 mfd—475v	32-1836	32-1836	—
	321	★	★	★	45-5008	12-8 mfd—475v	32-1836	32-1836	—
641	—	DC	32-7078	★	45-5008	★	32-1836	32-1647	—
642	—	32 Volt DC	★	★	45-5008	5 mfd— 50v	32-2006	32-2006	—

*Order by Model and Code Numbers. Substitute will be supplied.

REPLACEMENT PARTS LISTING—HOME RADIOS (Cont.)

MODEL	CODE	POWER TRANSFORMER	OUTPUT TRANSFORMER	SPEAKER	VOLUME CONTROL	FILTER CONDENSER	1st	I-F TRANSFORMER 2nd	3rd
643	—	Battery	32-7286	★	33-5119	2-4 mfd—150v 8 mfd—100v	32-1836	32-1836	—
645	121, 321	★	★	★	45-5008	8-12 mfd—475v	32-1836	32-1836	—
650	121	32-7283	32-7078	★	33-5119	10 mfd—50v 8-8 mfd—475v	32-1836	32-1836	—
	122	32-7283	32-7078	★	33-5119	10 mfd—50v 8-8 mfd—475v	32-1836	32-1836	—
	123	32-7283	32-7078	★	33-5119	10 mfd—50v 8-8 mfd—475v	32-1836	32-1836	—
	151	32-7283	32-7078	★	33-5119	10 mfd—50v 8-8 mfd—475v	32-1836	32-1836	—
651	121	AC-DC	★	★	45-5008	4-16-16-10 mfd— 150v 10 mfd—25v	32-1836	32-1836	—
655	121	32-7283	32-7078	★	33-5119	8-10 mfd— 450v/50v 8 mfd—475v	32-1836	32-1836	—
	122	32-7283	32-7078	★	33-5119	8-10 mfd— 450v/50v 8 mfd—475v	32-1836	32-1836	—
	123	32-7283	32-7078	★	33-5519	8-10 mfd— 450v/50v 8 mfd—475v	32-1836	32-1836	—
660	121	★	32-7078	★	33-5119	8-10 mfd— 450v/50v 8 mfd—475v	32-1864	32-1865	32-1866
	122	★	32-7078	★	33-5119	8-10 mfd— 450v/50v 8 mfd—475v	32-1864	32-1865	32-1866
665	121	★	32-7078	★	33-5119	8-10 mfd— 450v/50v 8 mfd—475v	32-1864	32-1865	32-1866
	122	★	32-7078	★	33-5119	8-10 mfd— 450v/50v 8 mfd—475v	32-1864	32-1865	32-1866
680	121	★	32-7461	★	45-5007	8-8-8 mfd—475v 4 mfd—300v 50 mfd—100v	★	★	—
	122	★	32-7461	★	45-5007	8-8-8 mfd—475v 4 mfd—300v 50 mfd—100v	★	★	—
901	—	—	★	★	45-5004	16-16 mfd—150v	—	—	—
905	—	★	★	★	45-5008	20-8-8 mfd—475v 10 mfd—50v	—	—	—
2620	121	32-7381	32-7567	★	45-5008	8-8 mfd—450v 16 mfd—400v	32-1646	32-1647	—
2625	—	32-7381	32-7567	★	45-5008	8-8 mfd—450v 16 mfd—400v	32-1646	32-1647	—

*Order by Model and Code Numbers. Substitute will be supplied.



REPLACEMENT PARTS LISTING—HOME RADIOS (Cont.)

MODEL	CODE	POWER TRANSFORMER	OUTPUT TRANSFORMER	SPEAKER	VOLUME CONTROL	FILTER CONDENSER	1st	I-F TRANSFORMER 2nd	3rd
2645	—	★	★	★	45-5008	8-12 mfd—475v	★	★	—
37-9	121	★	32-7634	★	33-5166	16 mfd—350v 10 mfd— 50v 20-8 mfd—475v	32-2333	32-2376	—
37-10	121	32-7640	32-7634	★	33-5166	† { 16 mfd—350v 10 mfd— 50v 8-20 mfd—475v	32-2333	32-2362	—
	125	32-7640	32-7634	★	33-5166		32-2333	32-2362	—
37-11	121	32-7640	32-7634	★	33-5166	† { 16 mfd—350v 10 mfd— 50v 8-20 mfd—475v	32-2333	32-2362	—
	125	32-7640	32-7634	★	33-5166		32-2333	32-2362	—
37-33	121	Battery	Replace Spkr.	★	33-5165	3 mfd—150v	32-1671	32-1672	—
37-34	121	★	Replace Spkr.	★	33-5165	4-8 mfd—150v	32-1671	32-1672	—
37-38	121	Battery	32-7639	★	33-5165	2-4-2 mfd—150v	32-1671	32-1672	—
37-60	121	32-7583	32-7567	★	33-5165	8-12 mfd—475v 16 mfd—400v	32-1671	32-1672	—
37-61	121	32-7583	32-7567	★	33-5165	8-12 mfd—475v 16 mfd—400v	32-1671	32-1672	—
37-62	121	★	32-7567	★	45-5007	8-8 mfd—475v 10 mfd— 50v	★	★	—
37-84	121-122	32-7180	32-7567	★	45-5010	8-4 mfd—450v	★	—	—
37-89	121	32-7583	32-7567	★	33-5165	8-12 mfd—475v	32-1671	32-1672	—
37-93	121	32-7552	32-7567	★	45-5019	8-8 mfd—475v 10 mfd— 50v	32-2457	★	—
37-116	121-122	32-7688	32-7078	★	33-5166	10 mfd—100v 8-8 mfd—475v 8 mfd—500v	Expander ★	Discriminator 32-2361	IF 32-2215
	125-126	32-7688	32-7078	★	33-5166	10 mfd—100v 8-8 mfd—475v 8 mfd—500v	Expander ★	Discriminator 32-2361	IF 32-2215
37-600	121	★	32-7567	★	33-5152	8-4 mfd—450v	★	—	—
37-602	121	AC-DC	32-7566	★	45-5019	16-16 mfd—150v	32-2672	32-2006	—
37-604	—	AC-DC	32-7566	★	★	8-16-16 mfd—150v	★	32-2006	—

†Common to all codes of this model.

*Order by Model and Code Numbers. Substitute will be supplied.



REPLACEMENT PARTS LISTING—HOME RADIOS (Cont.)

MODEL	CODE	POWER TRANSFORMER	OUTPUT TRANSFORMER	SPEAKER	VOLUME CONTROL	FILTER CONDENSER	I-F TRANSFORMER		
							1st	2nd	3rd
37-610	121	32-7583	32-7567	★	33-5166		32-1671	32-1672	—
	122	★	32-7567	★	33-5166	† { 8 mfd—475v 12 mfd—475v 16 mfd—400v	32-1671	32-1672	—
	125	32-7583	32-7567	★	33-5166		32-2275	32-2277	—
	126	★	32-7567	★	33-5166		32-1671	32-2277	—
	151	32-7583	32-7567	★	33-5166		32-1671	32-1672	—
37-611	121	AC-DC	★	★	33-5166		16-20 mfd—150v	32-1671	32-1672
	125	AC-DC	★	★	33-5166	16-20 mfd—150v	32-2297	32-2602	—
37-620	121	32-7583	32-7567	★	33-5166	† { 8-12 mfd—475v 16 mfd—400v	32-1671	32-1672	—
	122	32-7583	32-7567	★	33-5166		32-1671	32-1672	—
	125	32-7583	32-7567	★	33-5166		32-2275	32-2277	—
	126	32-7583	32-7567	★	33-5166		32-1671	32-1672	—
37-623	121	Battery	32-7639	★	33-5166	8-2 mfd—150v 2 mfd—100v	32-2297	32-2297	—
	125	Battery	32-7639	★	33-5166	8-2 mfd—150v 2 mfd—100v	32-2297	32-2297	—
37-624	121	★	32-7639	★	33-5166	4-8 mfd—200v	32-1671	32-1672	—
	125	★	32-7639	★	33-5166	4-8 mfd—200v	32-2297	32-2602	—
37-630	121	32-7583	32-7065	★	33-5166	12-8 mfd—475v 16 mfd—400v	32-1671	32-1672	—
	122	32-8214	32-7065	★	33-5166	12-8 mfd—475v 16 mfd—400v	32-1671	32-1672	—
	125	32-7583	32-7065	★	33-5166	12-8 mfd—475v 16 mfd—400v	32-2275	32-2277	—
	126	32-8214	32-7065	★	33-5166	12-8 mfd—475v 16 mfd—400v	32-2275	32-2277	—
37-640	121	32-7837	32-7634	★	33-5166	12-8-16 mfd—475v 10 mfd— 50v	32-1671	32-1672	—
	125	32-7837	32-7634	★	33-5166	12-8-16 mfd—475v 10 mfd— 50v	32-2275	32-2277	—
37-641	121	AC-DC	★	★	33-5166	16-16-10 mfd—150v	32-1671	32-1672	—
	125	AC-DC	★	★	33-5166	16-16-10 mfd—150v	32-2297	32-2602	—
37-643	121	Battery	32-7639	★	33-5166	8-2-2 mfd—150v	32-2253	32-2171	—
37-650	121	32-7640	32-7634	★	33-5166	10 mfd— 50v 20-8 mfd—475v 16 mfd—400v	32-2169	32-2171	—
	151	32-7640	32-7634	★	33-5166	10 mfd— 50v 20-8 mfd—475v 16 mfd—400v	32-2169	32-2171	—

†Common to all codes of this model.

*Order by Model and Code Numbers. Substitute will be supplied.

PARTS LIST



Use Genuine
PHILCO
PARTS

REPLACEMENT PARTS LISTING—HOME RADIOS (Cont.)

MODEL	CODE	POWER TRANSFORMER	OUTPUT TRANSFORMER	SPEAKER	VOLUME CONTROL	FILTER CONDENSER	1st	I-F TRANSFORMER 2nd	3rd
37-660	121	32-7699	32-7634	★	33-5166	8-8 mfd—475v	32-2169	32-2171	—
37-665	121	32-7640	32-7634	★	33-5166	10 mfd—50v 20-8 mfd—475v 16 mfd—400v	32-2169	32-2171	—
37-670	121	32-7640	32-7078	★	33-5166	8-8 mfd—475v 10 mfd—50v	32-2169	★	—
37-675	121	32-7699	32-7078	★	33-5166	4-4 mfd—400v 8-8 mfd—475v	32-2209	32-2211	Discriminator 32-2361
	122	32-7699	32-7078	★	33-5166	4-4 mfd—400v 8-8 mfd—475v	32-2209	32-2211	Discriminator 32-2361
37-690	121	★	32-7461	★	33-5166	8-8-8 mfd—475v 10 mfd—100v	32-2288	★	Discriminator 32-2361 32-2293
37-2620	121	32-7583	32-7567	★	33-5166	16-12-8 mfd—475v	32-2275	32-2277	—
37-2630	—	32-7583	32-7065	★	33-5166	16-12-8 mfd—475v	32-2275	32-2582	—
37-2650	121	32-7640	32-7634	★	33-5166	16-20-8 mfd—475v	32-2169	32-2171	—
37-2670	121	32-7640	32-7078	★	33-5166	8-8 mfd—475v 10 mfd—50v	32-2169	32-2171	—
38-1	121	32-7869	32-7914	★	45-5009	4-4-8-18 mfd—475v	32-2741	32-2742	—
38-2	121—Run 1	32-7869	32-7634	★	45-5009	4-4-8-18 mfd—475v	32-2604	32-2362	—
	121—Run 2	32-7869	32-7634	★	45-5009	4-4-8-18 mfd—475v	32-2741	32-2742	—
38-3	—	32-7640	32-7634	★	33-5166	18-8-16 mfd—475v	32-2604	32-2376	—
38-4	121	32-7837	32-7634	★	33-5399	16-18-8 mfd—475v 10 mfd—50v	32-2643	32-2645	—
38-5	121	32-7837	32-7634	★	33-5399	16-18-8 mfd—475v 10 mfd—50v	32-2643	32-2645	—
	321	32-7837	32-7634	★	33-5399	16-18-8 mfd—475v 10 mfd—50v	32-2643	32-2645	—
	254	32-7837	32-7634	★	33-5399	16-18-8 mfd—475v 10 mfd—50v	32-2643	32-2645	—
	322	32-7837	32-7634	★	45-5009	16-18-8 mfd—475v 10 mfd—50v	32-2643	32-2645	—
38-7	121	★	32-7065	★	33-5399	25-8 mfd—475v 4 mfd—350v	32-2775	32-2582	—
	124	★	32-7065	★	33-5399	25-8 mfd—475v 4 mfd—350v	32-2775	32-2582	—

*Order by Model and Code Numbers. Substitute will be supplied.



REPLACEMENT PARTS LISTING—HOME RADIOS (Cont.)

MODEL	CODE	POWER TRANSFORMER	OUTPUT TRANSFORMER	SPEAKER	VOLUME CONTROL	FILTER CONDENSER	I-F TRANSFORMER		
							1st	2nd	3rd
38-8	121	★	32-7567	★	45-5009	25-8 mfd—475v 4 mfd—350v	32-2775	32-2582	—
	321	★	32-7567	★	45-5009	25-8 mfd—475v 4 mfd—350v	32-2775	32-2582	—
38-9	121	★	32-7567	★	45-5009	25-8 mfd—475v 4 mfd—350v	32-2775	32-2582	—
	154	★	32-7567	★	45-5009	25-8 mfd—475v 4 mfd—350v	32-2775	32-2582	—
	321	★	32-7567	★	45-5009	25-8 mfd—475v 4 mfd—350v	32-2775	32-2582	—
38-10	121	★	32-7567	★	45-5007	12-8 mfd—475v 4 mfd—350v	32-2775	32-2582	—
	124	★	32-7567	★	45-5007	12-8 mfd—475v 4 mfd—350v	32-2775	32-2582	—
	321	★	32-7567	★	45-5007	12-8 mfd—475v 4 mfd—350v	32-2775	32-2582	—
38-12	Run 1 121	32-7826	32-8116	45-0004-2	45-5007	12-4 mfd—475v	32-2672	45-6365	—
	Run 6 121	32-7826	32-8116	45-0004-2	45-5007	12-4 mfd—475v	32-2672	45-6365	—
38-14	Run 1 121	AC-DC	★	45-0004-3	45-5007	16-20 mfd—150v	32-2672	45-6365	—
	Run 6 121	AC-DC	★	45-0004-3	45-5007	16-20 mfd—150v	32-2672	45-6365	—
	124	AC-DC	★	★	45-5007	16-20 mfd—150v	32-2672	45-6365	—
38-15	121	32-7826	32-8116	45-0004-2	45-5007	12 mfd—475v 4-2 mfd—350v	32-2672	32-3473	—
	124	32-7826	32-7567	45-0004-2	45-5007	12 mfd—475v 4-2 mfd—350v	32-2672	32-3473	—
38-17T	—	32-7826	32-8116	★	45-5007	12 mfd—475v 4-2 mfd—350v	32-2672	32-3473	—
38-17F	—	32-7826	32-7567	★	45-5007	12 mfd—475v 4-2 mfd—350v	32-2672	32-3473	—
38-22	121	AC-DC	★	★	33-5399	16-40-16 mfd—150v	32-2775	32-2582	—
	124	AC-DC	★	★	33-5399	16-40-16 mfd—150v	32-2775	32-2582	—
38-23	322	AC-DC	★	★	33-5399	16-40-16 mfd—150v	32-2775	32-2582	—
	121	AC-DC	★	★	33-5399	16-40-16 mfd—150v	32-2775	32-2582	—
38-33	121	Battery	32-7639	★	33-5249	—	32-2841	32-2602	—
38-34	125	★	32-7639	★	45-5018	4-8 mfd—250v	32-2841	32-2602	—
	121	★	32-7639	★	45-5018	4-8 mfd—250v	32-2841	32-2602	—
38-35	121	★	★	★	45-5018	12-8 mfd—350v	32-2775	★	—

*Order by Model and Code Numbers. Substitute will be supplied.

PARTS LIST



Use Genuine
PHILCO
PARTS

REPLACEMENT PARTS LISTING—HOME RADIOS (Cont.)

MODEL	CODE	POWER TRANSFORMER	OUTPUT TRANSFORMER	SPEAKER	VOLUME CONTROL	FILTER CONDENSER	1st	I-F TRANSFORMER 2nd	3rd
38-38	121	Battery	32-7639	★	45-5007	2-2-4 mfd—150v	32-2841	32-2602	—
38-39	121	★	32-7639	★	45-5007	4-8 mfd—350v	32-2841	32-2602	—
38-40	121	★	★	★	45-5007	25-8-8 mfd—475v	32-2275	32-2582	—
38-60	125	32-7583	32-8116	★	33-5165	12-8 mfd—475v	32-2275	32-2582	—
38-62	121	★	32-8116	★	45-5007	8-8 mfd—475v 10 mfd— 50v	32-2275	32-2582	—
38-89	121	32-7583	32-8116	★	33-5165	12 mfd—475v 8 mfd—475v	32-1671	32-1671	—
	125	32-7583	32-8116	★	33-5165	12 mfd—475v 8 mfd—475v	32-2775	32-2582	—
38-93	121	★	32-8116	★	45-5019	8-8 mfd—475v 10 mfd— 50v	32-2457	★	—
38-116	121	★	32-7078	★	33-5166	8-8-8-8-6 mfd—475v 8 mfd—300v	32-2727	32-2728	32-2660
	125	★	32-7078	★	33-5166	8-8-8-8-6 mfd—475v 8 mfd—300v	32-2727	32-2728	32-2660
38-250	121	AC-DC	★	★	45-5009	16-16 mfd—250v 40-10 mfd—250v	32-2643	32-2645	—
38-610	121	32-7583	32-8116	★	33-5166	12-8 mfd—475v 16 mfd—400v	32-2275	32-2277	—
	321	32-7583	32-8116	★	33-5166	12-8 mfd—475v 16 mfd—400v	32-2275	32-2582	—
	125	32-7583	32-8116	★	33-5166	12-8 mfd—475v 16 mfd—350v	32-2275	32-2582	—
38-620	121	32-7583	32-8116	★	33-5166	12-8 mfd—475v 16 mfd—350v	32-2275	32-2277	—
	125	32-7583	32-8116	★	33-5166	12-8 mfd—475v 16 mfd—350v	32-2275	32-2582	—
38-623	121	AC-DC	32-7639	★	33-5166	2-8-2 mfd—150v	32-3297	32-3617	—
	125	AC-DC	32-7639	★	33-5166	2-8-2 mfd—150v	32-2600	32-2602	—
38-624	121	AC-DC	32-7639	★	33-5166	4-8 mfd—200v	32-2297	32-2602	—
	125	AC-DC	32-7639	★	33-5166	4-8 mfd—200v	32-2600	32-2602	—
38-630	121	32-7583	32-8116	★	33-5166	12-8 mfd—475v 16 mfd—350v	32-2275	32-2277	—
	125	32-7583	32-8116	★	33-5166	12-8 mfd—475v 16 mfd—350v	32-2275	32-2582	—

*Order by Model and Code Numbers. Substitute will be supplied.



REPLACEMENT PARTS LISTING—HOME RADIOS (Cont.)

MODEL	CODE	POWER TRANSFORMER	OUTPUT TRANSFORMER	SPEAKER	VOLUME CONTROL	FILTER CONDENSER	I-F TRANSFORMER		
							1st	2nd	3rd
38-640	121	32-7837	32-7634	★	33-5166	20-8 mfd—475v 16 mfd—400v	32-1671	32-1672	—
	125	32-7837	32-7634	★	33-5166	20-8 mfd—475v 16 mfd—400v	32-2275	32-2277	—
38-641	—	AC-DC	★	★	33-5166	16-10 mfd—150v 10 mfd—25v	32-1671	32-1672	—
38-643	121	AC-DC	32-7639	★	33-5166	8-2 mfd—150v 2 mfd—100v	32-2169	32-2171	—
38-665	121	32-7640	32-7634	★	33-5166	20-8 mfd—475v 16 mfd—475v	32-2169	32-2171	—
38-690	121	32-7885	32-7905	★	33-5240	★	32-2772	32-2293	★
	125	★	32-7905	★	33-5240	★	32-2772	32-2293	★
38-2620	121	★	32-8116	★	33-5166	12 mfd—475v	32-2275	32-2277	—
	321	★	32-8116	★	33-5166	16 mfd—350v	32-2275	32-2277	—
	325	★	32-8116	★	33-5166	8 mfd—475v	32-2275	32-2582	—
38-2630	321	★	32-8116	★	33-5166	12 mfd—475v	32-2275	32-2582	—
	325	★	32-8116	★	33-5166	16 mfd—350v 8 mfd—475v	32-2275	32-2582	—
38-2650	121	★	32-7634	★	33-5166	20-8 mfd—475v 16 mfd—475v	32-2169	32-2171	—
	321	★	32-7634	★	33-5166	20-8 mfd—475v 16 mfd—475v	32-2169	32-2171	—
38-2670	121, 125	32-7640	32-7078	★	33-5166	8 mfd—475v 8-10 mfd— 475v/50v	32-2169	32-2171	—
	321, 325	32-7640	32-7078	★	33-5166	8 mfd—475v 8-10 mfd— 475v/50v	★	★	—
39-6	121	32-7979	32-8046	★	45-5007	4-12 mfd—300v	32-3120	32-3383	—
39-7	121	32-7979	32-8046	★	45-5007	4-12 mfd—300v	★	32-3383	—
	124	★	32-8116	45-0005-2	45-5007	12-4 mfd—450v	★	32-3383	—
39-8	121	AC-DC	★	45-0004-3	33-5276	16-20 mfd—150v	32-3018	32-3383	—
39-17	121	★	32-8116	★	33-5276	12-4 mfd—450v	32-3075	32-3473	—
	122	★	32-8116	★	33-5276	12-4 mfd—450v	32-3075	32-3473	—
39-18	121	AC-DC	★	45-0002-7	33-5276	40-20 mfd—150v	32-3075	32-3473	—
	122	AC-DC	★	45-0005-4	33-5276	40-20 mfd—150v	32-3075	32-3473	—

*Order by Model and Code Numbers. Substitute will be supplied.



REPLACEMENT PARTS LISTING—HOME RADIOS (Cont.)

MODEL	CODE	POWER TRANSFORMER	OUTPUT TRANSFORMER	SPEAKER	VOLUME CONTROL	FILTER CONDENSER	I-F TRANSFORMER		
							1st	2nd	3rd
39-19	121	★	32-8116	★	33-5276	8 mfd—450v 12 mfd—450v	32-3075	32-3473	—
	122	★	32-8116	45-0005-2	33-5276	8 mfd—450v 12 mfd—450v	32-3075	32-3473	—
39-25	121	★	★	★	45-5007	8 mfd—400v 16-16 mfd—250v	32-3018	★	—
	122	★	★	★	45-5007	8 mfd—400v 16-16 mfd—250v	32-3018	★	—
	124	★	★	★	45-5007	8 mfd—400v 16-16 mfd—250v	32-3018	★	—
39-30	121	★	★	★	45-5009	8 mfd—400v 16-16 mfd—250v	32-3018	★	—
39-31	121	32-8166	★	45-0006-3	45-5009	8 mfd—400v 16-16 mfd—250v	32-3018	★	—
39-35	121	32-8166	★	45-0006-3	45-5009	8 mfd—400v 16-16 mfd—250v	32-3018	★	—
39-36	121	32-8166	★	45-0006-3	33-5286	16 mfd—250v 8 mfd—400v 16 mfd—250v	32-3018	32-3129	—
39-40	121	★	32-7997	★	33-5286	4 mfd—250v 25 mfd—250v 18 mfd—400v	32-2643	32-2582	—
39-45	121	★	32-7997	★	33-5286	4 mfd—250v 25 mfd—250v 18 mfd—450v	32-2643	32-2582	—
39-55	121	★	32-7997	★	33-5300	4 mfd—250v 18 mfd—475v 25 mfd—300v 25 mfd—30v 16 mfd—200v	32-3089	32-2645	—
39-70	121	Battery	32-7995	36-1507	45-5018	3 mfd—150v	32-2841	32-3473	—
	122	Battery	32-7995	36-1508	45-5018	3 mfd—150v	32-2841	32-3473	—
39-71	121	Battery	★	36-1507	45-5018	3 mfd—150v	32-3103	32-3473	—
	122	Battery	★	36-1507	45-5017	3 mfd—150v	32-3103	32-3473	—
39-72	121	Battery	★	36-1507	45-5017	3 mfd—150v	32-3103	32-3176	—
39-75	121	Battery	32-7995	36-1507	33-5291	3 mfd—150v	32-3078	32-3473	—
	122	Battery	32-7995	36-1508	33-5291	3 mfd—150v	32-3078	32-3473	—
39-80	Bcab	Battery	32-8066	★	33-5288	3 mfd—150v	32-2841	32-3473	—
	Fcab	Battery	32-8066	★	33-5288	3 mfd—150v	32-2841	32-3473	—

*Order by Model and Code Numbers. Substitute will be supplied.

REPLACEMENT PARTS LISTING—HOME RADIOS (Cont.)

MODEL	CODE	POWER TRANSFORMER	OUTPUT TRANSFORMER	SPEAKER	VOLUME CONTROL	FILTER CONDENSER	1st	I-F TRANSFORMER 2nd	3rd
39-85	121	Battery	32-8066	★	33-5288	3-6 mfd—150v	32-2841	32-3473	—
39-116	121	32-7283	★	★	33-5300	4 mfd—250v 18 mfd—475v 25 mfd—300v 25 mfd—30v 16 mfd—200v	32-3089	32-2645	—
39-117	121	★	32-8116	F cab 45-0005-2	33-5276	4 mfd—450v 12 mfd—450v	32-3075	32-3473	—
39-118	121	AC-DC	★	★	33-5276	40-20 mfd—150v	32-3075	32-3473	—
39-119	121	★	32-8116	F cab 45-0005-2	33-5276	8-4-12 mfd—450v	32-3075	32-3473	—
39-175	121	Battery	32-7995	T cab 36-1507 F cab 36-1508	33-5291	3 mfd—150v	32-3078	32-3473	—
39-711	121	AC-DC	32-8033	★	45-5007	20-20 mfd—150v 6 mfd—50v	★	32-3383	—
39-744	121	★	★	T cab 36-1508 F cab 36-1456	45-5009	20-10-5-5 mfd— 150v	32-3328	32-3117	—
39-751	121	AC-DC	32-8028	T cab 36-1508 F cab 36-1456	45-5009	16-10 mfd— 300v/25v 20 mfd—150v 40 mfd—300v	32-3328	32-3133	—
39-770	121	32-8008	32-7997	T cab 36-1459	★	40 mfd—300v 18 mfd—475v	32-3284	★	—
39-2770	121	32-8008	32-7997	T cab 36-1459	★	40 mfd—300v 18 mfd—475v	32-3284	★	—
101	121	AC-DC	★	36-1469	45-5007	20-20 mfd—150v	32-3149	32-3426	—
105	121	32-7979	32-8116	45-0005-2	45-5007	10 mfd—450v 12 mfd—300v	32-2121	32-3383	—
107	121	32-7979	32-8116	45-0005-2	45-5007	10 mfd—450v 12 mfd—300v	32-2121	32-3383	—
108	121	32-8166	32-7978	45-0006-3	33-5286	16 mfd—250v 10 mfd—250v 8 mfd—450v	32-3018	32-3129	—
40-74	121	Battery	★	36-1507	45-5017	3 mfd—150v	32-3103	32-3176	—
40-81	121	Battery	32-8100	36-1507	45-5017	10 mfd—150v	32-3265	32-3266	—
	122	Battery	32-8100	36-1507	45-5017	10 mfd—150v	32-3265	32-3266	—

*Order by Model and Code Numbers. Substitute will be supplied.

PARTS LIST



Use Genuine
PHILCO
PARTS

REPLACEMENT PARTS LISTING—HOME RADIOS (Cont.)

MODEL	CODE	POWER TRANSFORMER	OUTPUT TRANSFORMER	SPEAKER	VOLUME CONTROL	FILTER CONDENSER	I-F TRANSFORMER		
							1st	2nd	3rd
40-82	121	Battery	32-8100	36-1507	45-5017	10 mfd—150v	32-3265	32-3266	—
40-83	121	Battery	32-8100	36-1507	45-5017	10 mfd—150v	32-3265	32-3266	—
40-84	121	AC-DC	32-8100	★	45-5017	20-10 mfd—150v 10-10-20 mfd— 150v/25v	32-3265	32-3266	—
40-88	121	Battery	★	36-1507	45-5017	6-6 mfd—150v	32-3222	32-3223	—
40-90	121	Battery	32-8051	★	45-5017	10 mfd—150v	32-3736	32-3181	—
40-95	121	Battery	32-8051	★	45-5018	10 mfd—150v	32-3736	32-3199	—
	122	Battery	32-8051	★	45-5018	10 mfd—150v	32-3736	32-3199	—
40-100	121	Battery	32-8051	36-1508	45-5018	10 mfd—150v	32-3736	32-3199	—
40-105	121	Battery	32-8066	★	33-5326	10 mfd—150v	32-3736	32-3199	—
40-110	121	Battery	32-8066	★	33-5326	10-10 mfd—150v	32-3736	★	—
40-115	121	AC-DC	★	36-1469	45-5007	20-20 mfd—150v	32-3237	32-3238	—
40-120	121	AC-DC	★	36-1469	45-5007	20-20 mfd—150v	32-3237	32-3238	—
40-124	121	AC-DC	★	36-1469	45-5007	20-20 mfd—150v	32-3237	32-3238	—
40-125	121	AC-DC	★	36-1469	45-5007	20-20 mfd—150v	32-3237	32-3238	—
40-130	121	32-8220	32-8116	45-0002-5	45-5007	4-12 mfd—400v	32-3210	32-3281	—
40-135	121	32-8220	32-8116	45-0002-5	45-5007	4-12 mfd—400v	32-3210	32-3281	—
40-140	121	32-8220	32-8116	45-0002-5	45-5007	4-12 mfd—400v	32-3210	32-3281	—
40-145	121	32-8220	32-8116	45-0002-5	45-5007	4-12 mfd—400v	32-3210	32-3281	—
40-150	121	32-8221	32-8133	36-1551	45-5009	16 mfd—200v 12 mfd—350v	32-3245	32-3383	—

*Order by Model and Code Numbers. Substitute will be supplied.



REPLACEMENT PARTS LISTING—HOME RADIOS (Cont.)

MODEL	CODE	POWER TRANSFORMER	OUTPUT TRANSFORMER	SPEAKER	VOLUME CONTROL	FILTER CONDENSER	1st	I-F TRANSFORMER 2nd	3rd
40-155	121	32-8221	32-8133	36-1551	45-5009	16 mfd—200v 12 mfd—350v	32-3245	32-3383	—
40-158	121	32-8221	32-8116	45-0005-2	45-5007	8-8 mfd—450v	32-3210	32-3211	—
40-160	121	32-8221	32-8116	45-0005-2	45-5007	4-4-8 mfd—450v	32-3210	32-3211	—
40-165	121	32-8221	32-8116	45-0005-2	45-5007	4-4-8 mfd—450v	32-3210	32-3211	—
40-170	121	32-8220	32-8116	45-0002-5	45-5007	4-12 mfd—400v	32-3210	32-3211	—
40-180	121	32-8221	32-8133	36-1590	45-5009	12 mfd—350v 16 mfd—200v	32-3245	32-3383	—
40-185	121	32-8221	32-8133	36-1590	45-5009	12 mfd—350v 16 mfd—200v	32-3245	32-3383	—
40-190	121	32-8221	32-8133	36-1590	45-5009	12 mfd—350v 16 mfd—200v	32-3245	32-3383	—
40-195	121	★	32-7997	★	33-5286	25 mfd—250v 18 mfd—420v	32-3243	32-2582	—
40-200	121	★	32-7997	★	33-5286	25 mfd—250v 18 mfd—400v	32-3243	32-2582	—
40-201	121	★	32-7997	★	33-5286	25 mfd—250v 18 mfd—400v	32-3243	32-2582	—
40-205	121	★	32-7997	★	33-5300	25 mfd—300v 18 mfd—475v	32-3089	32-2645	—
40-215	121	★	32-7997	★	33-5300	25 mfd—300v 18 mfd—475v	32-3089	32-2645	—
40-216	121	32-7283	★	★	33-5300	25 mfd—300v 18 mfd—475v	32-3089	32-2645	—
40-217	121	★	32-7997	★	33-5300	25 mfd—300v 18 mfd—475v	32-3089	32-2645	—
40-501	121	AC-DC	★	36-1469	45-5007	20-20 mfd—150v	32-3149	32-3426	—
40-502	121	AC-DC	★	36-1469	45-5007	20-20 mfd—150v	32-3149	32-3426	—
40-503	121	32-8220	32-8116	45-0902-5	45-5007	12-12 mfd—450v	32-3210	32-3281	—

*Order by Model and Code Numbers. Substitute will be supplied.

PARTS LIST



Use Genuine
PHILCO
PARTS

REPLACEMENT PARTS LISTING—HOME RADIOS (Cont.)

MODEL	CODE	POWER TRANSFORMER	OUTPUT TRANSFORMER	SPEAKER	VOLUME CONTROL	FILTER CONDENSER	I-F TRANSFORMER		
							1st	2nd	3rd
40-504	121	Battery	32-8116	36-1507	45-5017	8 mfd—150v	32-3103	32-3176	—
40-506	121	32-8220	32-8116	45-0002-5	45-5007	4-12-10 mfd—450v	32-3210	32-3281	—
40-507	121	★	32-7978	36-1489	45-5007	12-12 mfd—400v	32-3210	32-3281	—
40-508	121	★	32-7997	★	45-5009	12 mfd—450v 16 mfd—300v	32-3245	32-3383	—
40-509	121	★	32-7997	★	45-5009	12 mfd—450v 16 mfd—300v	32-3245	32-3383	—
40-510	121	★	32-7997	★	33-5300	18 mfd—475v 25 mfd—300v	32-3089	32-2645	—
40-515	121	★	32-7997	★	45-5009	12 mfd—450v 16 mfd—300v	32-3245	32-3383	—
40-516	121	32-7283	★	★	33-5300	25 mfd—300v 18 mfd—475v	32-3089	32-2645	—
40-525	121	32-8220	32-8116	45-0005-2	45-5007	12-20 mfd—475v 4 mfd—400v	32-3210	32-3281	—
40-526	121	32-8220	32-8116	45-0005-2	45-5007	12-20 mfd—475v 4 mfd—400v	32-3210	32-3281	—
40-527	121	32-8220	32-8116	45-0005-2	45-5007	12-20 mfd—475v 4 mfd—400v	32-3210	32-3281	—
40-710	121	AC-DC	★	★	45-5017	40-20-10 mfd—200v 20 mfd—25v	32-3297	32-3383	—
40-715	121	32-8006	★	★	45-5007	16 mfd—300v 16 mfd—400v	★	32-3383	—
40-725	121	32-8006	★	36-1562	45-5009	16 mfd—300v 16 mfd—400v	★	32-3133	—
40-748	121	★	★	T cab 36-1508 F cab 36-1456		5-5-10-20 mfd— 150v	32-3328	32-3188	—
40-755	121	32-8007	32-7997	T cab 36-1453 F cab ★	45-5009	40 mfd—300v 16 mfd—400v	★	32-3188	—
40-756	121	AC-DC	32-8028	T cab 36-1508 F cab 36-1456	45-5009	40-15 mfd—300v 20 mfd—150v	★	32-3133	—
40-780	121	32-8007	32-7997	T cab 36-1459 F cab ★	45-5009	16 mfd—300v 40 mfd—300v 4 mfd—300v	32-3284	32-3285	32-3286

*Order by Model and Code Numbers. Substitute will be supplied.



REPLACEMENT PARTS LISTING—HOME RADIOS (Cont.)

MODEL	CODE	POWER TRANSFORMER	OUTPUT TRANSFORMER	SPEAKER	VOLUME CONTROL	FILTER CONDENSER	1st	I-F TRANSFORMER 2nd	3rd
40-2710	121	AC-DC	★	★	45-5007	40-20-10 mfd—200v 20 mfd—25v	32-3297	32-3383	—
40-2725	121	32-8006	★	36-1562	45-5009	16 mfd—400v 12 mfd—450v	★	32-3133	—
40-2780	121	32-8007	32-7997	36-1459	45-5009	40 mfd—450v 4-16 mfd—300v	32-3284	32-3285	32-3286
41-KR	121	AC-DC	★	36-1469	45-5007	20-20 mfd—150v	32-3390	32-3391	—
41-RP-1	121	32-8043	—	—	—	6-6 mfd—150v	—	—	—
41-RP2	121	32-8043	—	—	—	6-6 mfd—150v	—	—	—
41-81	121	Battery	32-8100	36-1507	45-5017	10 mfd—150v	32-3265	32-3266	—
41-83	121	Battery	★	36-1507	45-5017	10 mfd—150v	32-3265	32-3266	—
41-84	121	Battery	32-8100	36-1481	45-5017	10-20-10-10 mfd—150v	32-3384	32-3266	—
	122	Battery	32-8100	36-1481	45-5017	10-20-10-10 mfd—150v	32-3583	32-3266	—
41-85	121	Battery	32-8100	36-1481	45-5017	10-20-10-10 mfd—150v	32-3265	32-3266	—
	122	Battery	32-8100	36-1481	45-5017	10-20-10-10 mfd—150v	32-3265	32-3266	—
41-90	121	Battery	32-8100	36-1481	45-5017	10 mfd—150v	32-3675	32-3199	—
41-95	121	Battery	★	36-1481	45-5017	10 mfd—150v	32-3736	32-3199	—
	122	Battery	★	36-1508	45-5017	10 mfd—150v	32-3736	32-3199	—
41-100	121	Battery	★	36-1507	45-5009	10 mfd—150v	32-3736	32-3199	—
	122	Battery	★	36-1508	45-5009	10 mfd—150v	32-3736	32-3199	—
41-105	121	Battery	★	36-1507	45-5007	10 mfd—150v	32-3736	32-3199	—
41-110	121	Battery	32-8152	45-0007	45-5007	10 mfd—150v	32-3550	32-3549	—
41-220	121	AC-DC	32-8144	36-1469	45-5007	20-20 mfd—150v	32-3489	32-3304	—

*Order by Model and Code Numbers. Substitute will be supplied.



REPLACEMENT PARTS LISTING—HOME RADIOS (Cont.)

MODEL	CODE	POWER TRANSFORMER	OUTPUT TRANSFORMER	SPEAKER	VOLUME CONTROL	FILTER CONDENSER	I-F TRANSFORMER		
							1st	2nd	3rd
41-221	121	AC-DC	32-8144	36-1469	45-5007	20-20 mfd—150v	32-3508	32-3509	32-3510
41-225	121	AC-DC	32-8144	36-1469	45-5007	20-20 mfd—150v	32-3489	32-3304	—
41-226	121	AC-DC	32-8144	36-1469	45-5007	20-20 mfd—150v	32-3508	32-3509	32-3510
41-230	121	32-8220	32-8116	45-0002-5	45-5007	4-4-12 mfd—475v	32-3465	32-3617	32-3467
41-235	121	32-8220	32-8116	45-0002-5	45-5007	4-4-12 mfd—475v	32-3465	32-3617	32-3467
41-240	121	32-8220	32-8116	45-0002-5	45-5007	4-4-12 mfd—400v	32-3465	32-3617	32-3467
41-245	121	32-8220	32-8116	45-0002-5	45-5007	4-4-12 mfd—400v	32-3465	32-3617	32-3467
41-246	121	32-8220	32-8116	45-0002-5	45-5007	4-4 mfd—400v 12 mfd—400v	32-3638	32-3639	32-3640
41-250	121	32-8221	32-8133	36-1551	45-5009	8-16 mfd—400v 12 mfd—475v	32-3482	32-3483	32-3484
41-258	122	AC-DC	★	45-0007	45-5007	20-20 mfd—150v	32-3508	32-3509	32-3538
41-22CL	—	AC-DC	32-8144	36-1469	45-5007	20-20 mfd—150v	32-3489	32-3304	—
41-260	121	★	32-8116	45-0007-2	45-5007	8-8 mfd—450v 12 mfd—475v	32-3465	32-3617	32-3467
41-265	121	★	32-8116	45-0007-2	45-5007	8-8 mfd—450v 12 mfd—475v	32-3465	32-3617	32-3467
41-280	121	32-8221	32-8133	36-1535	45-5009	8-16 mfd—400v 12 mfd—475v	32-3482	32-3483	32-3484
41-285	121	32-8221	32-8133	36-1535	45-5009	8-16 mfd—400v 12 mfd—475v	32-3482	32-3483	32-3484
41-287	121	32-8221	32-8133	36-1535	45-5009	8-16 mfd—400v 12 mfd—475v	32-3482	32-3483	32-3484
41-290	121	32-8221	32-8133	36-1535	45-5009	8-16 mfd—400v 12 mfd—475v	32-3482	32-3483	32-3484
41-295	121	★	32-7997	36-1535	33-5286	25 mfd—300v 18 mfd—375v	32-3493	32-3484	32-3495

*Order by Model and Code Numbers. Substitute will be supplied.



REPLACEMENT PARTS LISTING—HOME RADIOS (Cont.)

MODEL	CODE	POWER TRANSFORMER	OUTPUT TRANSFORMER	SPEAKER	VOLUME CONTROL	FILTER CONDENSER	1st	I-F TRANSFORMER 2nd	3rd
41-300	121	★	32-7997	36-1530	33-5286	25 mfd—300v 18 mfd—475v	32-3493	32-3494	32-3495
41-316	121	32-8186	32-7997	36-1530	33-5417	8 mfd—300v 25 mfd—300v 18 mfd—475v	32-3493	32-3494	32-3566
41-602	121	AC-DC	32-8228	36-1469	33-5462	20-20 mfd—150v	32-3390	32-3391	—
41-603	121	AC-DC	32-8206	36-1507	33-5462	20-20 mfd—150v	32-3508	32-3509	32-3510
41-604	121	Transformerless	32-8127	36-1507	33-5462	20-20 mfd—150v	32-3508	32-3509	32-3510
41-605	121	Transformerless	32-8127	36-1507	33-5462	20-20 mfd—150v	32-3508	32-3509	32-3510
41-607	121	Transformerless	32-8127	36-1507	33-5462	20-20 mfd—150v	32-3508	32-3509	32-3510
41-608	121	32-8166	32-8133	36-1590	45-5009	16-8 mfd—400v 12 mfd—400v	32-3465	32-3617	32-3534
	122	32-8166	32-8133	36-1590	45-5009	16-8 mfd—400v 12 mfd—400v	32-3465	32-3617	32-3534
41-609	121	32-8166	32-8133	36-1590	45-5009	16-8 mfd—400v 12 mfd—400v	32-3465	32-3617	32-3534
41-610	121	★	32-7997	36-1575	45-5009	8-16 mfd—475v 12 mfd—475v	32-3482	32-3483	32-3484
41-611	121	★	32-7997	36-1575	45-5009	8-16 mfd—475v 12 mfd—475v	32-3482	32-3483	32-3484
41-616	121	32-8166	32-7997	36-1530	33-5417	8 mfd—350v 25 mfd—350v 18 mfd—475v	32-3493	32-3494	32-3566
41-695	121	AC-DC	★	AD 1020	45-5017	10 mfd—150v	32-3583	32-3266	—
41-705	121	AC-DC	32-8296-5	36-1469	45-5007	40-20 mfd—150v	32-3540	32-3426	—
41-708	121	32-8128	32-8116	36-1520	45-5007	10-10-10 mfd—150v	32-3398	32-3399	—
41-712	121	32-8188	32-8116	45-0002-5	45-5007	10-10 mfd—300v 10 mfd—350v	32-3297	32-3399	—
41-713	121	AC-DC	★	36-1602	45-5007	10 mfd—350v	32-3398	32-3399	—
41-714	121	32-8188	32-8116	45-0002-5	45-5007	10 mfd—350v 10 mfd—250v	32-3398	32-3399	—

*Order by Model and Code Numbers. Substitute will be supplied.

PARTS LIST



Use Genuine
PHILCO
PARTS

REPLACEMENT PARTS LISTING—HOME RADIOS (Cont.)

MODEL	CODE	POWER TRANSFORMER	OUTPUT TRANSFORMER	SPEAKER	VOLUME CONTROL	FILTER CONDENSER	1st	I-F TRANSFORMER 2nd	3rd
41-722	121	32-8005	32-7978	36-1453	45-5009	15-15 mfd—475v	32-3429	32-3430	—
41-758	121	32-8109	32-7997	36-1453	45-5009	40 mfd—300v 15 mfd—475v	32-3429	32-3430	—
41-745	121	★	32-8113	36-1508	45-5009	5-10-20 mfd—150v	32-3442	32-3430	—
41-759	121	AC-DC	32-8112	36-1459	45-5009	40-20-20 mfd—150v	32-3429	32-3133	—
41-788	121	32-8109	32-7997	36-1459	33-5399	16 mfd—475v 5-5-40 mfd—350v	32-3982	32-3444	32-3445
41-841	121	AC-DC	32-8139	AD1020	45-5017	20-10-20 mfd—150v 20 mfd— 25v	32-3583	32-3266	—
41-851	121	AC-DC	32-8139	36-1507	33-5462	10-10-10-20 mfd— 150v	32-3583	32-3266	—
PT25	121	AC-DC	32-8296-5	36-1469	45-5007	20-20 mfd—150v	32-3149	32-3426	—
	122	AC-DC	32-8296-5	36-1469	45-5007	20-20 mfd—150v	32-3149	32-3426	—
PT26	121	AC-DC	32-8296-5	36-1469	45-5007	20-20 mfd—150v	32-3149	32-3426	—
	122	AC-DC	32-8296-5	36-1469	45-5007	20-20 mfd—150v	32-3149	32-3426	—
PT27	122	AC-DC	32-8296-5	36-1469	45-5007	20-20 mfd—150v	32-3149	32-3426	—
PT28	121	AC-DC	32-8296-5	36-1469	45-5007	20-20 mfd—150v	32-3149	32-3426	—
PT29	121	AC-DC	32-8296-5	36-1469	45-5007	20-20 mfd—150v	32-3390	32-3391	—
PT30	121	AC-DC	32-8296-5	★	45-5007	20-20 mfd—150v	32-3560	32-3561	—
PT31	121	AC-DC	32-8296-5	36-1469	45-5007	20-20 mfd—150v	32-3149	32-3426	—
PT33	121	AC-DC	32-8296-5	36-1469	45-5007	20-20 mfd—150v	32-3177	32-3178	—
PT35	121	AC-DC	32-8296-5	36-1469	45-5007	20-20 mfd—150v	32-3149	32-3426	—
PT36	121	AC-DC	32-8296-5	36-1469	45-5007	20-20 mfd—150v	32-3390	32-3391	—

*Order by Model and Code Numbers. Substitute will be supplied.



REPLACEMENT PARTS LISTING—HOME RADIOS (Cont.)

MODEL	CODE	POWER TRANSFORMER	OUTPUT TRANSFORMER	SPEAKER	VOLUME CONTROL	FILTER CONDENSER	I-F TRANSFORMER		
							1st	2nd	3rd
PT37	121	AC-DC	32-8296-5	36-1469	45-5007	20-40 mfd—150v	32-3327	32-3426	—
PT38	121	AC-DC	32-8296-5	36-1469	45-5007	20-40 mfd—150v	32-3327	32-3426	—
PT39	121	AC-DC	32-8296-5	36-1469	45-5007	20-20 mfd—150v	32-3149	32-3426	—
PT41	121	AC-DC	32-8296-5	36-1469	45-5007	20-20 mfd—150v	32-3177	65-0192	—
	122	AC-DC	32-8296-5	36-1469	45-5007	20-20 mfd—150v	32-3177	65-0192	—
PT42	121	AC-DC	32-8144	★	45-5007	20-20 mfd—150v	32-3560	32-3561	—
PT43	121	AC-DC	32-8296-5	36-1469	45-5007	20-20 mfd—150v	32-3177	65-0192	—
PT44	121	AC-DC	32-8144	★	45-5007	20-20 mfd—150v	32-3560	32-3561	—
PT45	121	AC-DC	32-8296-5	36-1469	45-5007	20-20 mfd—150v	32-3149	32-3426	—
PT46	121	AC-DC	32-8296-5	36-1469	45-5007	20-20 mfd—150v	32-3390	32-3391	—
PT47	121	AC-DC	32-8296-5	36-1469	45-5007	20-20 mfd—150v	32-3149	32-3426	—
PT48	121	AC-DC	32-8296-5	36-1469	45-5007	20-20 mfd—150v	32-3390	32-3391	—
PT49	121	AC-DC	32-8296-5	★	45-5007	20-20 mfd—150v	32-3560	32-3561	—
PT50	121	AC-DC	32-8296-5	36-1469	45-5007	20-20 mfd—150v	32-3177	65-0192	—
PT51	121	AC-DC	32-8296-5	36-1469	45-5007	20-20 mfd—150v	32-3149	32-3426	—
PT53	121	AC-DC	32-8296-5	36-1469	45-5007	20-40 mfd—150v	32-3327	32-3426	—
PT55	121	AC-DC	32-8296-5	36-1469	45-5007	20-20 mfd—150v	32-3177	65-0192	—
PT57	121	AC-DC	32-8296-5	36-1469	45-5007	20-20 mfd—150v	32-3177	65-0192	—
PT59	121	AC-DC	32-8296-5	36-1469	45-5007	20-20 mfd—150v	32-3149	32-3426	—

*Order by Model and Code Numbers. Substitute will be supplied.

PARTS LIST



Use Genuine
PHILCO
PARTS

REPLACEMENT PARTS LISTING—HOME RADIOS (Cont.)

MODEL	CODE	POWER TRANSFORMER	OUTPUT TRANSFORMER	SPEAKER	VOLUME CONTROL	FILTER CONDENSER	I-F TRANSFORMER		
							1st	2nd	3rd
PT61	121	AC-DC	32-8296-5	36-1469	45-5007	20-20 mfd—150v	32-3177	65-0192	—
	122	AC-DC	32-8296-5	36-1469	45-5007	20-20 mfd—150v	32-3177	65-0192	—
PT63	121	Battery	32-8100	36-1507	45-5017	10 mfd—150v	32-3265	32-3266	—
PT65	121	AC-DC	32-8296-5	36-1469	45-5007	20-20 mfd—150v	32-3177	65-0192	—
PT66	121	AC-DC	32-8296-5	36-1469	45-5007	20-20 mfd—150v	32-3177	65-0192	—
PT67	121	AC-DC	32-8296-5	36-1469	45-5007	20-20 mfd—150v	32-3177	65-0192	—
PT69	121	AC-DC	32-8296-5	36-1469	45-5007	20-20 mfd—150v	32-3177	65-0192	—
	122	AC-DC	32-8296-5	36-1469	45-5007	20-20 mfd—150v	32-3177	65-0192	—
PT87	121	AC-DC	32-8296-5	36-1469	45-5007	20-10-20 mfd—150v 20 mfd—25v	32-3560	32-3561	—
PT89	121	Battery	32-8296-5	36-1614	33-5410	10 mfd—150v	32-3472	32-3473	—
TH9	121	AC-DC	32-8296-5	36-1469	45-5007	20-40 mfd—150v	32-3149	32-3426	—
TH14	121	AC-DC	32-8296-5	36-1469	45-5007	20-20 mfd—150v	32-3177	65-0192	—
TH15	121	AC-DC	32-8296-5	36-1469	45-5007	20-20 mfd—150v	32-3177	65-0192	—
TH16	121	AC-DC	32-8296-5	36-1469	45-5007	20-20 mfd—150v	32-3177	65-0192	—
TH17	121	AC-DC	32-8296-5	36-1469	45-5007	20-20 mfd—150v	32-3177	65-0192	—
TH18	121	AC-DC	32-8296-5	36-1469	45-5007	20-40 mfd—150v	32-3149	32-3426	—
TH22	121	AC-DC	32-8296-5	36-1469	45-5007	20-40 mfd—150v	32-3149	32-3426	—
TP20	121	AC-DC	32-8296-5	36-1469	45-5007	20-20 mfd—150v	32-3177	65-0192	—
TP21	121	AC-DC	32-8296-5	36-1469	45-5007	20-20 mfd—150v	32-3177	65-0192	—

*Order by Model and Code Numbers. Substitute will be supplied.



REPLACEMENT PARTS LISTING—HOME RADIOS (Cont.)

MODEL	CODE	POWER TRANSFORMER	OUTPUT TRANSFORMER	SPEAKER	VOLUME CONTROL	FILTER CONDENSER	1st	I-F TRANSFORMER 2nd	3rd
42PT2	121	AC-DC	32-8173	36-1591	45-5007	20-20 mfd—150v	32-3603	32-3604	—
	122	AC-DC	32-8173	36-1591	45-5007	20-20 mfd—150v	32-3603	32-3604	—
42PT4	121	AC-DC	32-8173	36-1591	45-5007	20-20 mfd—150v	32-3603	32-3604	—
	122	AC-DC	32-8173	36-1591	45-5007	20-20 mfd—150v	32-3603	32-3604	—
42PT7	121	AC-DC	32-8173	36-1591	45-5007	20-20 mfd—150v	32-3603	32-3604	—
	122	AC-DC	32-8173	36-1591	45-5007	20-20 mfd—150v	32-3603	32-3604	—
42PT10	121	AC-DC	32-8173	36-1591	45-5007	20-20 mfd—150v	32-3614	32-3604	—
42PT25	—	AC-DC	★	36-1469	45-5007	20-20 mfd—150v	32-3149	32-3426	—
42PT26	—	AC-DC	★	36-1469	45-5007	20-20 mfd—150v	32-3390	32-3391	—
42PT27	—	AC-DC	★	36-1469	45-5007	20-20 mfd—150v	32-3149	32-3426	—
42PT28	—	AC-DC	★	36-1469	45-5007	20-20 mfd—150v	32-3390	32-3391	—
42PT36	—	AC-DC	★	36-1469	45-5007	20-20 mfd—150v	32-3390	32-3391	—
42PT39	—	AC-DC	★	36-1469	45-5007	20-20 mfd—150v	32-3149	32-3426	—
42PT87	—	AC-DC	★	★	45-5017	20-10-20 mfd—150v 20 mfd—25v	32-3584	32-3473	—
42PT88	—	AC-DC	★	★	45-5017	20-10-20 mfd—150v 20 mfd—25v	32-3584	32-3473	—
42PT91	—	AC-DC	32-8173	36-1592	45-5007	20-20 mfd—150v	32-3673	32-3952	—
42PT92	—	AC-DC	32-8173	36-1592	45-5007	20-20 mfd—150v	32-3673	32-3952	—
42PT93	—	AC-DC	32-8173	36-1592	45-5007	20-20 mfd—150v	32-3673	32-3752	—
42PT94	—	AC-DC	32-8173	36-1592	45-5007	20-20 mfd—150v	32-3673	32-3952	—
42PT95	—	AC-DC	32-8173	36-1592	45-5007	20-20 mfd—150v	32-3673	32-3952	—

*Order by Model and Code Numbers. Substitute will be supplied.

PARTS LIST



Use Genuine
PHILCO
PARTS

REPLACEMENT PARTS LISTING—HOME RADIOS (Cont.)

MODEL	CODE	POWER TRANSFORMER	OUTPUT TRANSFORMER	SPEAKER	VOLUME CONTROL	FILTER CONDENSER	I-F TRANSFORMER		
							1st	2nd	3rd
42-321	121	AC-DC	32-8173	36-1591	45-5007	20-20 mfd—150v	32-3614	32-3604	—
42KR3	—	AC-DC	32-8144	36-1469	45-5007	20-20 mfd—150v	32-3390	32-3391	—
42KR5	—	AC-DC	32-8144	36-1469	45-5007	20-20 mfd—150v	32-3390	32-3391	—
42-22CL	—	AC-DC	32-8144	36-1469	45-5007	20-20 mfd—150v	32-3489	32-3304	—
42-121CB	121	Battery	32-8100	36-1507	45-5017	10 mfd—150v	32-3675	32-3199	—
42-122T	121	Battery	32-8152	36-1507	45-5017	10 mfd—150v	32-3706	32-3199	—
42-123F	121	Battery	32-8152	36-1507	45-5017	10 mfd—150v	32-3736	32-3199	—
42-124T	121	Battery	32-8175	AD1020	★	10 mfd—150v	32-3737	32-3621	32-3733
42-125K	121	Battery	32-8175	AD1020	★	10 mfd—150v	32-3737	32-3621	32-3733
42-126T	121	Battery	32-8175	AD1020	★	10 mfd—150v	32-3737	32-3621	32-3733
42-322	121	AC-DC	32-8173	36-1591	45-5007	20-20-10 mfd—150v	32-3859	32-3860	—
42-323	121	AC-DC	32-8173	36-1591	45-5007	20-20 mfd—150v	32-3711	32-3712	32-3713
	122	AC-DC	32-8173	36-1591	45-5007	20-20 mfd—150v	32-3711	32-3712	32-3713
42-327	121	AC-DC	32-8173	36-1591	45-5007	20-20 mfd—150v	32-3711	32-3712	32-3713
	122	AC-DC	32-8173	36-1591	45-5007	20-20 mfd—150v	32-3711	32-3712	32-3713
42-335	121	32-8220— 60 cycle 32-7975— 25 cycle	32-8172	36-1570	45-5007	4-4-12 mfd—450v	32-3734	32-3705	32-3640
42-340	121	32-8220	32-8172	36-1570	45-5007	4-4-12 mfd—450v	32-3734	32-3705	32-3640
42-345	121	32-8220	32-8172	36-1570	45-5007	4-4-12 mfd—400v	32-3734	32-3705	32-3640
42-350	121	32-8220	32-8172	36-1570	33-5470	4-4-12 mfd—400v	32-3794	32-3836	32-3789

*Order by Model and Code Numbers. Substitute will be supplied.



REPLACEMENT PARTS LISTING—HOME RADIOS (Cont.)

MODEL	CODE	POWER TRANSFORMER	OUTPUT TRANSFORMER	SPEAKER	VOLUME CONTROL	FILTER CONDENSER	I-F TRANSFORMER		
							1st	2nd	3rd
42-355	121	32-8221	32-8133	36-1551	45-5009	8-8 mfd—400v 18 mfd—450v	32-3787	32-3836	32-3789
42-358	121	AC-DC	32-8206	36-1508	45-5007	20-20 mfd—150v	32-3773	32-3774	32-3775
	122	AC-DC	32-8206	45-0005-2	45-5007	20-10-10 mfd—150v	32-3773	32-3774	32-3775
42-360	121	★	32-8116	45-0007-2	45-0007	8-8 mfd—400v 12 mfd—400v	32-3465	32-3639	32-3640
42-365	121	★	32-8116	36-1535	45-5007	8-8-12 mfd—400v	32-3465	32-3639	32-3640
42-380	121	★	32-8133	36-1590	45-5009	8-8 mfd—475v 18 mfd—475v	32-3742	32-3743	32-3744
42-390	121	32-8221	32-8133	36-1590	45-5009	8-8 mfd—450v 18 mfd—450v	32-3787	32-3836	32-3789
42-395	121	32-8223— 60 cycle ★—25 cycle	32-7997	36-1530	45-5009	8-8 mfd—475v 18 mfd—475v	32-3828	32-3836	32-3829
42-400	121	★—60 cycle 32-8214— 25 cycle	32-7997	36-1530	33-5286	12-18 mfd—400v 25 mfd—250v	32-3820	32-3821	32-3821
42-706	121	AC-DC	32-8173	36-1591	45-5007	20-40 mfd—150v	32-3603	32-3781	—
A707	121	AC-DC	32-8173	36-1591	45-5007	20-40 mfd—150v	32-3603	32-3781	—
42-716	121	32-8093— 60 cycle 32-7975— 25 cycle	32-8116	45-0002-5	45-5007	10-10 mfd—350v	32-3813	32-3654	—
42-717	121	AC-DC	★	36-1602	45-5007	40-20-10 mfd—200v 20 mfd—25v	32-3813	32-3654	—
42-718	121	32-8128	32-8116	36-1520	45-5007	10-10 mfd—150v	32-3813	32-3722	—
42-724	121	32-8188	32-8189	36-1551	45-5007	40 mfd—350v 12-5 mfd—300v	32-3813	32-3814	—
42-730	121	32-8109 60 cycle 32-8031 25 cycle	★	★	45-5009	40 mfd—350v 15 mfd—450v	32-3696	32-3657	—
42-760	121	32-8109— 60 cycle 32-8031 25 cycle	32-7997	36-1453	45-5009	40 mfd—350v 15 mfd—450v	32-3659	32-3660	—
42-761	121	AC-DC	32-8170	45-0005-2	45-5009	40-10 mfd—200v 20-20 mfd—150v 20 mfd—25v	32-3659	32-3688	—
42-762	121	★	32-8113	36-1508	45-5009	20-10-5 mfd—150v	32-3813	32-3660	—

*Order by Model and Code Numbers. Substitute will be supplied.



REPLACEMENT PARTS LISTING—HOME RADIOS (Cont.)

MODEL	CODE	POWER TRANSFORMER	OUTPUT TRANSFORMER	SPEAKER	VOLUME CONTROL	FILTER CONDENSER	1st	I-F TRANSFORMER 2nd	3rd
42-788	121	32-8109— 60 cycle 32-8031— 25 cycle	32-7997	36-1459	33-5399	40 mfd—450v 50-5-5 mfd—300v	32-3982	32-3444	32-3445
	122	32-8109— 60 cycle 32-8031— 25 cycle	32-7997	36-1459	33-5399	40 mfd—450v 50-5-5 mfd—300v	32-3982	32-3444	32-3445
42-842	—	AC-DC	★	AD1020	45-5018	30-20-10 mfd—150v 200-50 mfd—25v	32-3620	32-3621	32-3631
42-843	—	AC-DC	★	AD1020	45-5018	30-20-10 mfd—150v 200-50 mfd—25v	32-3620	32-3621	32-3631
42-844	—	AC-DC	★	AD1020	45-5018	30-20-10 mfd—150v 200-50 mfd—25v	32-3620	32-3621	32-3631
42-853	—	AC-DC	★	AD1020	45-5018	30-20-10 mfd—150v 200-50 mfd—25v	32-3620	32-3621	32-3631
42-854	—	AC-DC	★	AD1020	45-5018	30-20-10 mfd—150v 200-50 mfd—25v	32-3620	32-3621	32-3631
42-1001P	121	None	32-8173	36-1541	33-5437	40-40 mfd—150v	32-3603	32-3604	—
42-1001	122	None	32-8173	36-1541	33-5437	40-40 mfd—150v	32-3603	32-3604	—
42-1002	121	None	32-8173	36-1507	33-5462	40-40 mfd—150v	32-3614	32-3604	—
	122	None	32-8173	45-0002-5	33-5462	40-40 mfd—150v	32-3614	32-3604	—
42-1003	121	None	32-8206	36-1593	45-5009	40-40 mfd—150v	32-3616	32-3617	32-3758
	122	None	32-8206	36-1562	45-5009	40-40 mfd—150v	32-3616	32-3617	32-3758
42-1004	121	None	32-8206	45-0007-2	33-5462	10-40-40 mfd—150v	32-3777	32-3848	—
42-1005	121	None	32-8127	★	45-5009	6-40-40 mfd—150v	32-3616	32-3617	32-3758
	122	None	32-8206	45-0007-2	45-5009	6-40-40 mfd—150v	32-3616	32-3617	32-3758
42-1006	122	None	32-8206	45-0007-2	45-5007	10-40-40 mfd—150v	32-3777	32-3618	—
42-1008	121	★	32-8133	36-1590	45-5009	12 mfd—475v 16-8 mfd—475v	32-3623	32-3617	32-3467
42-1009W	121	★	32-8133	36-1590	45-5009	12 mfd—475v 16-8 mfd—475v	32-3623	32-3617	32-3467
42-1009M	121	★	32-8133	36-1590	45-5009	12 mfd—475v 16-8 mfd—475v	32-3623	32-3617	32-3467
42-1010	121	32-8226	32-7997	36-1575	45-5009	18-8-8 mfd—475v	32-3742	32-3850	32-3851

*Order by Model and Code Numbers. Substitute will be supplied.



REPLACEMENT PARTS LISTING—HOME RADIOS (Cont.)

MODEL	CODE	POWER TRANSFORMER	OUTPUT TRANSFORMER	SPEAKER	VOLUME CONTROL	FILTER CONDENSER	1st	I-F TRANSFORMER 2nd	3rd
42-1011W	121	32-8226	32-7997	36-1575	45-5009	18-8-8 mfd—475v	32-3742	32-3850	32-3851
42-1011M	121	32-8226	32-7997	36-1575	45-5009	18-8-8 mfd—475v	32-3742	32-3850	32-3851
42-1012	121	32-8226	32-7997	36-1575	45-5009	18-18-8-8 mfd—475v	32-3843	32-3844	32-3845
42-1013W	121	32-8226	32-7997	36-1575	45-5009	18-18-8-8 mfd—475v	32-3843	32-3844	32-3845
42-1013M	121	32-8226	32-7997	36-1575	45-5009	18-18-8-8 mfd—475v	32-3843	32-3844	32-3845
42-1015	121	★	32-8184	36-1595	33-5286	18 mfd—475v 25 mfd—300v 8 mfd—350v	32-3820	32-3821	32-3821
42-1016	121	32-8186	32-8184	★	33-5417	18 mfd—475v 25 mfd—300v 8 mfd—350v	32-3801	32-3802	32-3803
A361	—	32-8221	65-0454	73-0074	67-0060	15-10 mfd—350v 20-10-5 mfd—350v	65-0460	65-0461	—
A801	—	32-8231	65-0363	36-1580	67-0040	20 mfd—25v	65-0365	65-0366	—
42RP1	121	32-8043	—	—	—	6-6 mfd—150v	—	—	—
42RP2	121	32-8043	—	—	—	6-6 mfd—150v	—	—	—
46-131	121	Battery	32-8240	36-1507	33-5493	10 mfd—150v	32-3966	32-3897	—
	122	Battery	32-8297	36-1507-2	33-5493	10 mfd—150v	32-3966	32-3897	—
46-132	121	Battery	32-8152	36-1507	33-5493	10 mfd—150v	32-3949	32-3963	—
46-142	121	Battery	32-8389-2	36-1507	33-5493	10 mfd—150v	32-3949	32-3897	—

*Order by Model and Code Numbers. Substitute will be supplied.



REPLACEMENT PARTS LISTING—HOME RADIOS (Cont.)

MODEL	CODE	POWER TRANSFORMER	OUTPUT TRANSFORMER	SPEAKER	VOLUME CONTROL	FILTER CONDENSER	I-F TRANSFORMER		
							1st	2nd	3rd
46-200	121	AC-DC	32-8296-5	36-1592	33-5429	20-20 mfd—150v	32-3675	32-3952	—
	122	AC-DC	32-8296-5	36-1614	33-5429	30-25-20 mfd—150v	32-3675	32-3952	—
	125	AC-DC	32-8296-5	36-1614	33-5429	30-25-20 mfd—150v	32-3675	32-3952	—
46-250	121	AC-DC	32-8296-5	36-1591	33-5429	20-20 mfd—150v	32-3968	32-3952	—
	122	AC-DC	32-8296-5	36-1615	45-5007	30-25-20 mfd—150v	32-3968	32-3952	—
	125	AC-DC	32-8296-5	36-1615	45-5007	30-25-20 mfd—150v	32-3968	32-3952	—
	126	AC-DC	32-8296-5	36-1615	45-5007	30-25-20 mfd—150v	32-3968	32-3952	—
46-350	121	Battery	32-8259	36-1598	33-5526	30-10-30 mfd—150v 30 mfd—25v	32-3970	32-3971-2	—
	122	Battery	32-8259	36-1598	33-5526	30-10-30 mfd—150v 30 mfd—25v	32-3970	32-3971-2	—
	125	Battery	32-8259	36-1598	33-5526	30-10-30 mfd—150v 30 mfd—25v	32-3970	32-3971-2	—
46-420	121	AC-DC	32-8296-5	36-1591	33-5491	20-20 mfd—150v	32-4026	32-3952	—
	122	AC-DC	32-8296-5	36-1615	33-5491	30-25-20 mfd—150v	32-4026	32-3952	—
	128	AC-DC	32-8296-5	36-1615	33-5491	30-25-20 mfd—150v	32-4026	32-3952	—
46-421	121	AC-DC	32-8296-5	36-1591	45-5007	20-20 mfd—150v	32-3962	32-3952	—
46-427	121	AC-DC	32-8296-5	36-1591	45-5007	20-20 mfd—150v	32-3773	32-3957	32-3958
46-431	121	32-8220	32-8278	36-1604	33-5535	15 mfd—400v 25-10 mfd—400v	32-4106	32-4107	32-4108
46-451	121	32-8234	32-8278	36-1585	33-5535-2	20 mfd—450v 10-25 mfd—450v	32-4106	32-4107	32-4108
46-480	121	32-8243	32-8249	36-1595	33-5535-1	20 mfd—450v 10-25 mfd—450v	32-4020	32-4022	32-4074

*Order by Model and Code Numbers. Substitute will be supplied.



REPLACEMENT PARTS LISTING—HOME RADIOS (Cont.)

MODEL	CODE	POWER TRANSFORMER	OUTPUT TRANSFORMER	SPEAKER	VOLUME CONTROL	FILTER CONDENSER	1st	I-F TRANSFORMER		4th
								2nd	3rd	
46-806	121	AC-DC	32-8296-5	36-1591	45-5007	20-40 mfd—200v	32-3675	32-4032	—	
46-816	121	32-8271	32-8116	36-1601	45-5007	10-10mfd—350v	32-3895	32-3907	—	
46-817	121	AC-DC	32-8296-5	36-1602	45-5007	40-20-10 mfd—200v 20 mfd—25v	32-3899	32-3907	—	
46-818	121	32--8128	32-8116	36-1520	45-5007	10-10 mfd—150v 10 mfd—150v	32-3899	32-3907	—	
46-860	121	32-8270	32-7997	36-1453	45-5009	15 mfd—450v 40 mfd—450v	32-3980	32-3981	—	
46-888	121	32-8270	32-7997	36-1459	45-5009	40 mfd—450v 50 mfd—450v 5-5 mfd—200v	32-3982	32-3983	32-3984	
46-1201	121	—	32-8296-5	36-1587 36-1617	33-5519	15 mfd—150v 15 mfd—150v 40 mfd—150v	32-3968	AD1024	—	
	122	—	32-8310	36-1617-2	33-5519	30-25-20 mfd—150v	32-3968	AD1024	—	
	125	—	32-8296-5	36-1587 36-1617	33-5519	15 mfd—150v 15 mfd—150v 40 mfd—150v	32-3968	AD1024	—	
	126	—	32-8296-5	36-1587	33-5519	15 mfd—150v 15 mfd—150v 40 mfd—150v	32-4160	AD1024	—	
	127	—	32-8310	36-1617-1 36-1617-2	33-5519	15 mfd—150v 15 mfd—150v	32-3968	AD1024	—	
	128	—	32-8310	36-1617-2	33-5519	40-10 mfd—200v 15 mfd—150v 15 mfd—150v	32-4160-1	32-4161-1	—	
	130	—	32-8310	36-1617-2	33-5519	40-10 mfd—200v 15 mfd—150v 15 mfd—150v	32-3968	AD1024	—	
	130	—	32-8310	36-1617-2	33-5519	40-10 mfd—200v				
46-1203	121	—	32-8242	36-1593	33-5503	15 mfd—150v 15 mfd—150v 40-10 mfd—200v	32-3962	32-3952	—	
	122	—	32-8242	36-1613	33-5503	15 mfd—150v 15 mfd—150v	32-3962	32-3952	—	
	125	—	32-8242	36-1593	33-5503	40-10 mfd—200v 15 mfd—150v 15 mfd—150v	32-3962	32-3952	—	
	126	—	32-8242	36-1593	33-5503	40-10 mfd—200v 40-10 mfd—250v 15 mfd—200v	32-3962	32-3952	—	
46-1209	121	32-8248	32-8274	36-1595	33-5535-1	20 mfd—450v 10-25 mfd—450v	32-4106	32-4107	32-4108	
	122	32-8248	32-8274	36-1595	33-5535-1	20 mfd—450v 10-25 mfd—450v	32-4106	32-4107	32-4108	
46-1213	121	32-8282	32-8274	36-1606	33-5535-5	30-15-10 mfd—450v 15-10 mfd—450v 15 mfd—450v	32-4020-1	32-4001	32-4002	32-4003-2
46-1226	121	32-8248	32-8274	36-1595	33-5535-1	25-10 mfd—450v 20 mfd—450v	32-4106	32-4107	32-4108	
	122	32-8248	32-8274	36-1595	33-5535-1	25-10 mfd—450v 20 mfd—450v	32-4106	32-4107	32-4108	
	125	32-8248	32-8274	36-1611-2	33-5535-1	25-10 mfd—450v 25-10 mfd—450v	32-4106	32-4107	32-4108	

*Order by Model and Code Numbers. Substitute will be supplied.

PARTS LIST



Use Genuine
PHILCO
PARTS

REPLACEMENT PARTS LISTING—HOME RADIOS (Cont.)

MODEL	CODE	POWER TRANSFORMER	OUTPUT TRANSFORMER	SPEAKER	VOLUME CONTROL	FILTER CONDENSER	I-F TRANSFORMER		
							1st	2nd	3rd
47-204	122	AC-DC	32-8296-5	36-1614	33-5429	30-25-20 mfd—150v	32-3675	32-3952	—
	125	AC-DC	32-8296-5	36-1614	33-5429	30-25-20 mfd—150v	32-3675	32-3952	—
47-205	125	AC-DC	32-8296-5	36-1614	33-5429	30-25-20 mfd—150v	32-3675	32-3952	—
47-1227	121	32-8248	32-8274	36-1595	33-5535-1	20 mfd—450v 10-25 mfd—450v	32-4146	32-4156	32-4147
47-1230	121	32-8248	32-8274	36-1595	33-5535-1	20 mfd—450v 25-25 mfd—450v	32-4146	32-4156	32-4147
48-141	121	Battery	32-8323	36-1507-3	33-5554	10 mfd—150v	32-3949-1	32-3897	—
48-145	121	Battery	32-8323	36-1507-3	33-5554	10 mfd—150v	32-3949-1	32-3897	—
48-150	121	Battery	32-8323	36-1507-3	33-5554	10 mfd—150v	32-3949-1	32-3897-2	—
48-200	121	AC-DC	32-8296-5	36-1614	33-5429	30-25-20 mfd—150v	32-3675	32-3952	—
	125	AC-DC	32-8296-5	36-1614	33-5429	30-25-20 mfd—150v	32-3675	32-3952	—
48-206	121	AC-DC	32-8296-5	36-1614	33-5429	30-25-20 mfd—150v	32-3675	32-3952	—
	125	AC-DC	32-8296-5	36-1614	33-5429	30-25-20 mfd—150v	32-3675	32-3952	—
48-214	121	AC-DC	32-8296-5	36-1614	33-5429	30-25-20 mfd—150v	32-3675	32-3952	—
	125	AC-DC	32-8296-5	36-1614	33-5429	30-25-20 mfd—150v	32-3675	32-3952	—
48-225	121	AC-DC	32-8296-5	36-1614	33-5429	30-25-20 mfd—150v	32-3675	32-3952	—
48-230	121	AC-DC	32-8296-5	36-1614	33-5429	30-25-20 mfd—150v	32-3675	32-3952	—
48-250	121	AC-DC	32-8296-5	36-1615	45-5007	30-25-20 mfd—150v	32-3968	32-3952	—
	122	AC-DC	32-8296-5	36-1591	45-5007	20-20 mfd—150v	32-3968	32-3952	—
	126	AC-DC	32-8296-5	36-1615	45-5007	30-25-20 mfd—150v	32-3968	32-3952	—
48-300	121	Battery	32-8259	36-1598	33-5526	30-30-10 mfd—150v 30 mfd—25v	32-3968-4	32-3987-1	—
48-360	121	Battery	32-8259	36-1598	33-5526	30-30-10 mfd—150v 30 mfd—150v	32-3970	32-3971-2	—
	122	Battery	32-8259	36-1598	33-5526	30-30-10 mfd—150v 30 mfd—150v	32-3970	32-3971-2	—

*Order by Model and Code Numbers. Substitute will be supplied.



REPLACEMENT PARTS LISTING—HOME RADIOS (Cont.)

MODEL	CODE	POWER TRANSFORMER	OUTPUT TRANSFORMER	SPEAKER	VOLUME CONTROL	FILTER CONDENSER	I-F TRANSFORMER			
							1st	2nd	3rd	4th
48-460	121	AC-DC	32-8296-5	36-1615	33-5491	30-25-20 mfd—150v	32-4151	32-4152	—	
	122	AC-DC	32-8296-5	36-1615	33-5491	30-25-20 mfd—150v	32-4151	32-4152	—	
48-461	121	AC-DC	32-8296-5	36-1615	45-5007	30-25-20 mfd—150v	32-4151	32-4152-1	—	
	122	AC-DC	32-8296-5	36-1615	45-5007	30-25-20 mfd—150v	32-4151	32-4152-1	—	
48-464	121	AC-DC	32-8296-5	36-1615-1	33-5539-11	30-25-20 mfd—150v	32-3956-2	32-3957-2	32-3955-2	
48-472	121	AC-DC	32-8296-4	36-1604-1	33-5539-19	40-70-40 mfd—150v	32-4146-1	32-4156	32-4079	
	122	AC-DC	32-8296-4	36-1625	33-5539-19	40-70-40 mfd—150v 2 mfd—50v 25 mfd—25v	32-4258	32-4160-3	32-4240-2	
48-475	121	32-8234	32-8278	36-1507-3	33-5535-11	20 10-10 mfd—450v 30-10 mfd—450v	32-4146-2	32-4156-2	42-4147-1	
48-482	121	32-8281	32-8249	36-1608	33-5535-3	30-15-10 mfd—450v 10-15 mfd—450v 15 mfd—450v	32-4020-1	32-4001	32-4002	32-4003-2
48-485	121	AC-DC	32-8242-3	36-1626-1	33-5535-15	15 mfd—200v 75-10 mfd—250v	32-4151-1	32-3948-9	—	
48-805	121	AC-DC	32-8296-5	36-1614	33-5538-13	30-25-20 mfd—150v	32-3968-3	32-3948-5	—	
48-808	121	AC-DC	32-8296-5	36-1627	33-5538-26	40-30-20 mfd—200v 10 mfd—25v	32-3675	32-3948-14	—	
48-810	121	AC-DC	32-8321-1	36-1615-2	33-5539-21	40-30-20 mfd—200v 10 mfd—25v	32-3675	32-3948-7	—	
48-821	121	AC-DC	32-8321	36-1615-2	33-5539-26	40 mfd—200v 40 mfd—200v	32-3895-1	32-3908-1	—	
48-828	121	32-8269	32-8189	36-1551	33-5510	16 mfd—475v 40 mfd—350v	32-3899	32-3907	—	
48-861	121	AC-DC	32-8170	36-1508	45-5009	40-10 mfd—200v 20-20 mfd—150v 20 mfd—25v	32-3980	32-3978	—	
48-862	121	32-7682	32-8113	36-1508	45-5009	15 mfd—200v 20-10-5 mfd—150v	65-0319	32-3981	—	
48-870	121	32-8246-1	32-8300-1	36-1455-1	45-5009	10 mfd—25v 15 mfd—450v 20-10-10 mfd—450v	32-3980	32-3981	—	
48-890	121	32-8246-1	32-8300-2	36-1610-1	33-5535-14	40 mfd—450v 20-10-10 mfd—450v 25 mfd—25v	32-3982-1	32-3983	—	
48-1200	121	None	32-8310-3	36-1625	33-5538-20	50-50-10 mfd—150v	None	None	—	

*Order by Model and Code Numbers. Substitute will be supplied.



REPLACEMENT PARTS LISTING—HOME RADIOS (Cont.)

MODEL	CODE	POWER TRANSFORMER	OUTPUT TRANSFORMER	SPEAKER	VOLUME CONTROL	FILTER CONDENSER	I-F TRANSFORMER			
							1st	2nd	3rd	4th
48-1201	121	None	32-8310	36-1617-2	33-5519	15 mfd—200v 15 mfd—200v 40-10 mfd—250v	32-4160	32-4161	—	
	122	None	32-8310	36-1617-2	33-5519	15 mfd—200v 15 mfd—200v 40-10 mfd—250v	32-4160	32-4161	—	
48-1253	121	None	32-8329	36-1625	33-5558	15 mfd—200v 15 mfd—200v 40-10 mfd—250v	32-3962-3	32-3948-11	—	
	122	None	32-8329	36-1625	33-5558	15 mfd—200v 15 mfd—200v 40-10 mfd—250v	32-3962-3	32-3948-11	—	
48-1256	121	None	32-8242	36-1613	33-5503	15 mfd—200v 15 mfd—200v 40-10 mfd—250v	32-3962	AD1024	—	
48-1260	121	None	32-8310-1	36-1626	33-5519	15 mfd—200v 15 mfd—200v 40-10 mfd—250v	32-4160	32-4161	—	
48-1262	121	None	32-8242-3	36-1626	33-5539-22	15 mfd—200v 15 mfd—200v 75-10 mfd—250v	32-4151-1	32-3948-9	—	
	122	None	32-8242-3	36-1626-1	33-5539-22	15 mfd—200v 15 mfd—200v 75-10 mfd—250v	32-4151-1	32-3948-9	—	
48-1263	121	32-8248	32-8274	36-1595	33-5535-1	10-25 mfd—450v 20 mfd—450v	32-3956-3	32-3957-3	32-3955-3	
48-1264	121	32-8248	32-8274	36-1595	33-5535-1	20 mfd—450v 10-25 mfd—450v	32-4146	32-4156	32-4147	
	122	32-8248	32-8274	36-1595	33-5535-1	20 mfd—450v 10-20 mfd—450v	32-4146	32-4156	32-4147	
48-1266	121	32-8248	32-8274	36-1595	33-5535-1	20 mfd—450v 25-25 mfd—450v	32-4146	32-4156	32-4147	
48-1270	121	32-8282	32-8274	36-1606	33-5535-5	40 mfd—450v 30-15-10 mfd—450v	32-4020-1	32-4001	32-4002	32-4003-2

*Order by Model and Code Numbers. Substitute will be supplied.



REPLACEMENT PARTS LISTING—HOME RADIOS (Cont.)

MODEL	CODE	POWER TRANSFORMER	OUTPUT TRANSFORMER	SPEAKER	VOLUME CONTROL	FILTER CONDENSER	1st	I-F TRANSFORMER			4th
								2nd	3rd		
48-1274	121	32-8286	32-8287	36-1612	33-5535-6	40 mfd—450v 10-30 mfd—450v 15-10-10 mfd—450v	32-4072	32-4060	32-4060	32-4003-1	
48-1276	121	32-8286	32-8287	36-1612	33-5535-6	40 mfd—450v 10-30 mfd—450v 15-10-10 mfd—450v	32-4072	32-4060	32-4060	32-4003-1	
48-1282	121	None	32-8242-3	36-1626-1	33-5539-22	15 mfd—200v 15 mfd—200v 75-10 mfd—250v	32-4151-1	32-3948-9	—		
48-1283	121	None	32-8242-3	36-1626-1	33-5539-22	15 mfd—200v 15 mfd—200v 75-10 mfd—250v	32-4151-1	32-3948-9	—		
48-1284	121	32-8350	32-8274	36-1611-3	33-5535-16	35 mfd—450v 40-10 mfd—250v	32-4258	32-4160-3	32-4240-2	—	
48-1286	121	32-8248	32-8274	36-1611-3	33-5535-1	20 mfd—450v 25-10 mfd—450v 2 mfd—50v	32-4146	32-4156	32-4147	—	
48-1290	121	32-8282	32-8274	36-1606	33-5535-5	10 mfd—450v 10-10 mfd—450v 40 mfd—450v	32-4020-1	32-4001	32-4002	32-4003-2	
48-1805	121	None	32-8310-2	36-1617-2	33-5538-18	50-30-20 mfd—150v 10 mfd—25v	32-3675	32-3948-10	—		
48-1826	121	32-8327	32-8330	36-1613-2	33-5535-13	20-10-10 mfd—450v 40 mfd—350v	32-3895-1	32-3908-1	—		
48-1827	121	32-8327	32-8330	36-1455-1	33-5535-13	20-10-10 mfd—450v 40 mfd—350v	32-3895-1	32-3908-1	—		
48-1860 (D10)	121	32-8246-1	32-8300	36-1611	33-5506	40 mfd—450v 50 mfd—450v 5-5 mfd—200v	32-3980	32-3981	—		
	122	32-8246-1	32-8300	36-1611	33-5506	40 mfd—450v 50 mfd—450v 5-5 mfd—200v	32-3980	32-3981	—		
48-2860	121	32-8270	32-7997	36-1453	45-5009	15 mfd—450v 40 mfd—350v	32-3980	32-3981	—		

*Order by Model and Code Numbers. Substitute will be supplied.

PARTS LIST



Use Genuine
PHILCO
PARTS

REPLACEMENT PARTS LISTING—HOME RADIOS (Cont.)

Model	Code	Power Transformer	Output Transformer	Speaker	Volume Control	Filter Condenser	1st	IF TRANSFORMERS 2nd	3rd	4th
49-100	121	Battery	32-8323	36-1507-3	33-5554	—	32-3949-1	32-3897	—	—
49-500	121	AC-DC	32-8296-5	36-1614	33-5429	30-25-20 mfd-150v	32-3967	32-3952	—	—
49-501	121	AC-DC	32-8296-5	36-1627	33-5538-21	30-25-20 mfd-150v	32-4160-6	32-4240	—	—
49-503	121	AC-DC	32-8296-5	36-1614	33-5429	30-25-20 mfd-150v	32-3967	32-3952	—	—
49-504	121	AC-DC	32-8296-5	36-1615	33-5434	30-25-20 mfd-150v	32-3968	32-3948	—	—
49-505	121	AC-DC	32-8296-5	36-1625-6	33-5538-37	30-25-20 mfd-150v	32-4160-6	32-4240	—	—
49-506	121	AC-DC	32-8296-5	36-1614	33-5429	30-25-20 mfd-150v	32-3967	32-3952	—	—
49-601	121	Battery	—	36-1627-1	33-5538-28	10 mfd-150v 30 mfd- 25v	32-4160-4	32-3987-2	—	—
49-602	121	Battery and AC-DC	—	36-1627-1	33-5538-28	30-30-20 mfd-150v 30 mfd- 25v	32-4160-4	32-3987-2	—	—
49-603	121	AC-DC	32-8296-5	76-4606	33-5538-42	30-25-20 mfd-150v	32-4160-6	32-4240	—	—
49-605	121	Battery and AC-DC	32-8259	36-1598	33-5538-43	30-10-30 mfd-250v 60 mfd- 25v	32-3970	32-3971-2	—	—
49-607	121	Battery and AC-DC	32-8259	36-1598	33-5526	30-30-10 mfd-150v 30 mfd- 25v	32-3970	32-3971-2	—	—
49-900	121	AC-DC	32-8296-5	36-1615	33-5491	30-25-20 mfd-150v	32-4151	32-4152	—	—
49-901	121	AC-DC	32-8296-5	36-1627	33-5556-6	30-25-20 mfd-150v	32-4160-6	32-4240	—	—
49-902	121	AC-DC	32-8310-3	36-1625	33-5538-21	40-30-30 mfd-150v	32-4258	32-4240-3	—	—
49-904	121	AC-DC	32-8310-3	36-1625	33-5539-46	40-30-30 mfd-150v	32-4258	32-4240-3	—	—
49-905	121	AC-DC	32-8296-5	36-1614	33-5538-39	40-70-40 mfd-150v	32-4257 (FM) 32-4258 (AM)	32-4257-1 (FM) 32-4240 (AM)	32-4310 (FM)	—
49-906	121	AC-DC	32-8296-4	36-1615-2	33-5538-36	40-70-40 mfd-150v	32-4257 (FM) 32-4258 (AM)	32-4257-1 (FM) 32-4160-3 (AM)	32-4240-2 (AM) 32-4261-1 (FM)	— —

REPLACEMENT PARTS LISTING—HOME RADIOS (Cont.)

Model	Code	Power Transformer	Output Transformer	Speaker	Volume Control	Filter Condenser	1st	IF TRANSFORMERS			4th
								2nd	3rd		
49-909	121	None	32-8242	36-1629	33-5535-17	40-40-20 mfd-250v	32-4257 (FM) 32-4258 (AM)	32-4257-1 (FM) 32-4160-3 (AM)	32-4240-2 (AM) 32-4261-1 (FM)	— —	— —
49-1100	121	None	32-8242-3	36-1626-1	33-5535-15	15-15 mfd-200v 75-10 mfd-250v	32-4151-1	32-3948-9	—	—	—
49-1101	121	None	32-8242	36-1626-1	33-5535-17	40-40-20 mfd-250v	32-4257 (FM) 32-4258 (AM)	32-4257-1 (FM) 32-4160-3 (AM)	32-4240-2 (AM) 32-4261-1 (FM)	— —	— —
49-1401	121	None	32-8351	36-1625	33-5538-30	75-20 mfd-250v	32-4160	32-4240	—	—	—
49-1404	121	None	32-8242-4	36-1629	33-5564-2	40-40-20 mfd-250v	32-4160	32-4240	—	—	—
49-1405	121	None	32-8242-4	36-1629	33-5564-2	40-40-20 mfd-250v	32-4160	32-4240	—	—	—
49-1600	121	None	32-8242-3	36-1626-1	33-5539-51	75-40-10 mfd-250v	32-4160	32-4240	—	—	—
49-1602	121	None	32-8242-3	36-1626-1	33-5535-18	75-40-10 mfd-250v	32-4258	32-4160-3	32-4240-3	—	—
49-1603	121	None	32-8242-3	36-1626-1	33-5535-18	75-40-10 mfd-250v	32-4258	32-4160-3	32-4240-3	—	—
49-1604	121	None	32-8242-3	36-1626-1	33-5535-18	75-40-10 mfd-250v	32-4258	32-4160-3	32-4240-3	—	—
49-1605	121	None	32-8242-3	36-1626-1	33-5535-18	75-40-10 mfd-250v	32-4258	32-4160-3	32-4240-3	—	—
49-1606	121	None	32-8367-1	36-1610-2	33-5535-17	40-40-20 mfd-250v	32-4257 (FM) 32-4258 (AM)	32-4257-1 (FM) 32-4160-3 (AM)	32-4261-1 (FM) 32-4240-2 (AM)	— —	— —
49-1607	121	None	32-8367-1	36-1610-2	33-5535-17	40-40-20 mfd-250v	32-4257 (FM) 32-4258 (AM)	32-4257-1 (FM) 32-4160-3 (AM)	32-4261-1 (FM) 32-4240-2 (AM)	— —	— —
49-1609	121	None	32-8367-1	36-1610-2	33-5535-17	40-40-20 mfd-250v	32-4257 (FM) 32-4258 (AM)	32-4257-1 (FM) 32-4160-3 (AM)	32-4261-1 (FM) 32-4240-2 (AM)	— —	— —
49-1611	121	None	32-8367-1	36-1610-2	33-5535-17	40-40-20 mfd-250v	32-4257 (FM) 32-4258 (AM)	32-4257-1 (FM) 32-4160-3 (AM)	32-4261-1 (FM) 32-4240-2 (AM)	— —	— —
49-1613	121	32-8248	32-8274	36-1611-3	33-5535-1	10-20-25 mfd-450v	32-4146	32-4156	32-4147	—	—
49-1615	121	32-8378	32-8379	36-1630	33-5535-19	10-25-40 mfd-475v	32-4257 (FM) 32-4258 (AM)	32-4257-1 (FM) 32-4160-3 (AM)	32-4261-1 (FM) 32-4240-2 (AM)	— —	— —

PARTS LIST



Use Genuine
PHILCO
PARTS

REPLACEMENT PARTS LISTING BY PHILCO MODEL NUMBER AUTO-RADIO MODELS

MODEL	CODE	POWER TRANSFORMER	OUTPUT TRANSFORMER	SPEAKER	VOLUME CONTROL	FILTER CONDENSER	I-F TRANSFORMER		
							1st	2nd	3rd
3	—	Battery	★	★	★	★	★	★	—
5 (6V)	—	Battery	★	★	★	4-8 mfd—450v	★	★	—
5 (12V)	—	Battery	★	★	★	4-8 mfd—450v	★	★	—
6	—	Battery	★	★	★	—	★	★	—
7	—	Battery	★	★	★	—	★	★	—
8	—	Battery	★	★	★	—	★	★	—
9	—	Battery	32-7634	★	★	—	★	★	—
10 (6V)	—	★	★	★	★	4-8 mfd—450v	★	★	—
10 (12V)	—	★	★	★	★	4-8 mfd—450v	★	★	—
11 (6V)	—	32-7352	32-7567	★	★	4-8 mfd—450v	32-1538	★	—
11 (12V)	—	32-7352	32-7567	★	★	4-8 mfd—450v	32-1538	★	—
12	—	Dynamotor	★	★	★	—	★	★	—
700	—	32-7352	32-7567	★	★	—	★	★	—
800	—	★	32-7078	★	★	4-8 mfd—450v	★	★	—
800	122	★	32-7078	★	★	4-8 mfd—450v	32-1621	★	—
802	—	★	32-7078	★	★	4-8 mfd—400v	32-1621	★	—
805	—	32-7352	32-7567	★	★	4-4 mfd—350v	★	★	—
806	—	32-7352	32-7567	★	★	8-4 mfd—350v	36-1621	★	—
808	—	32-7352	32-7078	★	★	8-4-8 mfd—350v	36-1621	★	—
809	—	32-7352	★	★	★	8-4 mfd—350v	32-1621	★	—

*Order by Model and Code Numbers. Substitute will be supplied.



REPLACEMENT PARTS LISTING—AUTO RADIOS (Cont.)

MODEL	CODE	POWER TRANSFORMER	OUTPUT TRANSFORMER	SPEAKER	VOLUME CONTROL	FILTER CONDENSER	I-F TRANSFORMER		
							1st	2nd	3rd
816	—	32-7352	★	★	★	4-4 mfd—350v	32-2252	32-2027	—
817	—	★	★	★	★	4-8 mfd—350v	32-2026	32-2027	—
818	—	32-7552	★	★	★	4-8 mfd—350v	32-2026	32-2027	—
818K	—	★	32-7562	★	★	4-8 mfd—350v	32-2026	32-2027	—
819	—	★	★	★	★	8-8 mfd—350v	32-2026	★	—
819H	—	★	★	★	★	8-8 mfd—350v	32-2026	★	—
810P	—	32-7352	★	★	★	★	★	★	—
810PV	—	32-7352	★	★	★	4-8 mfd—350v	32-1621	★	—
811P	—	32-7352	★	★	★	★	★	★	—
811PV	—	32-7352	★	★	★	4-4 mfd—350v	32-2252	32-2027	—
821P	—	★	★	★	33-5121	4-8 mfd—350v	32-2026	32-2027	—
821PV	—	★	★	★	33-5121	4-8 mfd—350v	32-2026	32-2027	—
822P	—	★	★	★	67-0033	20 mfd—50v 10-15 mfd—350v	32-2026	32-2027	—
822PV	—	★	★	★	67-0033	20 mfd—50v 10-15 mfd—350v	32-2026	32-2027	—
826	—	★	★	★	33-5121	4-8 mfd—350v	32-2026	32-2027	—
827	—	★	★	★	33-5121	4-8 mfd—350v	32-2026	32-2027	—
827K	—	★	★	★	33-5121	4-8 mfd—350v	32-2026	32-2027	—
828	—	32-7821	★	★	33-5121	4-8 mfd—350v	32-2026	32-2027	—
828K	—	32-7821	★	★	33-5121	4-8 mfd—400v	32-2026	32-2027	—
920	—	★	32-7961	★	45-5007	4-4 mfd—350v	32-2286	32-2995	—
921	—	★	32-8000	★	33-5278	4-4 mfd—350v	32-3078	32-3076	—
922	—	★	32-8000	★	33-5278	4-4 mfd—350v	32-2286	32-3076	—

*Order by Model and Code Numbers. Substitute will be supplied.

PARTS LIST



Use Genuine
PHILCO
PARTS

REPLACEMENT PARTS LISTING—AUTO RADIOS (Cont.)

MODEL	CODE	POWER TRANSFORMER	OUTPUT TRANSFORMER	SPEAKER	VOLUME CONTROL	FILTER CONDENSER	I-F TRANSFORMER		
							1st	2nd	3rd
926	—	65-0095	32-7956	★	33-5268	4-4 mfd—350v	32-2286	32-3014	—
927	—	32-7821	★	★	33-5268	4-8 mfd—350v	32-2286	32-3014	—
928K	—	32-7821	★	★	33-5268	4-8 mfd—350v	32-2286	32-3014	—
931	—	65-0404	65-0221	★	67-0042	10-10 mfd—350v	65-0399	65-0192	—
932	—	65-0404	65-0221	★	67-0042	10-10 mfd—350v	65-0399	65-0192	—
933	—	65-0046	★	★	67-0019	10-10 mfd—350v	65-0160	65-0230	—
936	—	65-0046	65-0048	★	33-5268	10-10 mfd—350v	65-0044	65-0045	—
937	—	65-0046	65-0048	★	33-5268	10-10 mfd—350v	65-0044	65-0045	—
938K	—	65-0095	★	★	33-5268	10-10 mfd—350v	65-0044	65-0045	—
AR1	—	65-0404	65-0258	73-0027	67-0042	10-15-20 mfd— 350/350/25v	65-0399	65-0192	—
AR4	—	65-0234	65-0317	73-0053	67-0032	10-15-20 mfd— 350/350/25v	65-0399	65-0320	—
AR5	—	65-0234	65-0317	73-0047	67-0032	10-15-20 mfd— 350/350/25v	65-0319	65-0320	—
AR6	—	65-0046	65-0048	★	33-5268	10-15-20 mfd— 350/350/25v	65-0044	65-0230	—
AR7	—	★	65-0048	★	33-5268	10-15-20 mfd— 350/350/25v	65-0044	65-0230	—
AR8	—	65-0095	★	73-0056	33-5268	10-15-20 mfd— 350/350/25v	65-0044	65-0230	—
AR9	—	65-0234	65-0317	36-1609-3	67-0032	10-15-20 mfd 250/350/25v	65-0015	65-0320	—
AR10	—	65-0404	65-0258	73-0027	67-0020	10-10-20 mfd— 200/150/25v	65-0399	65-0192	—
AR40	—	65-0234	65-0277	★	★	10-15-20 mfd— 350/350/25v	65-0319	65-0320	—

*Order by Model and Code Numbers. Substitute will be supplied.

REPLACEMENT PARTS LISTING—AUTO RADIOS (Cont.)

MODEL	CODE	POWER TRANSFORMER	OUTPUT TRANSFORMER	SPEAKER	VOLUME CONTROL	FILTER CONDENSER	I-F TRANSFORMER		
							1st	2nd	3rd
AR45	—	65-0234	65-0408	73-0047	★	10-15-20 mfd— 350/350/25v	65-0319	65-0320	—
AR50	—	65-0234	65-0277	★	★	10-15-20 mfd— 350/350/25v	65-0319	65-0320	—
AR55	—	65-0234	65-0408	73-0047	★	10-15-20 mfd— 350/350/25v	65-0319	65-0320	—
AR65	—	65-0234	65-0408	73-0047	★	10-15-20 mfd— 350/350/25v	65-0319	65-0320	—
AR75	—	65-0403	32-7928	73-0056	★	5-10-20-20 mfd— 350/350/350/25v	65-0319	65-0320	—
PA	—	Dynamotor	★	★	★	—	★	★	—
PB	—	32-7110	★	★	★	4-8 mfd—350v	★	★	—
SC	121	★	★	★	★	4-8 mfd—350v	★	★	—
	122	★	★	★	★	4-8 mfd—350v	★	★	—
ND	121	★	★	★	★	4-8 mfd—350v	★	★	—
	122	★	★	★	★	4-8 mfd—350v	★	★	—
ME	121	★	★	★	★	4-8 mfd—350v	★	★	—
CG	121	32-7110	★	★	★	4-8 mfd—350v	★	★	—
	122	★	★	★	★	4-8 mfd—350v	32-1538	★	—
HH	121	★	32-7078	★	★	4-8 mfd—350v	★	★	—
	122	★	32-7078	★	★	4-8 mfd—350v	32-1621	★	—
PHXD	—	★	★	★	★	4-8 mfd—350v	★	★	—
NJ	121	32-7352	32-7567	★	★	4-8 mfd—350v	32-1538	★	—
	122	32-7352	32-7567	★	★	4-8 mfd—350v	32-1538	★	—
SJ	121	32-7352	32-7567	★	★	4-8 mfd—350v	32-1538	★	—
	122	32-7352	32-7567	★	★	4-8 mfd—350v	32-1538	★	—

*Order by Model and Code Numbers. Substitute will be supplied.



REPLACEMENT PARTS LISTING—AUTO RADIOS (Cont.)

MODEL	CODE	POWER TRANSFORMER	OUTPUT TRANSFORMER	SPEAKER	VOLUME CONTROL	FILTER CONDENSER	1st	I-F TRANSFORMER 2nd	3rd
FN	—	32-7352	32-7567	★	★	4-8 mfd—350v	32-1538	★	—
NQ	—	32-7352	32-7567	★	★	—	★	★	—
SQ	—	32-7352	32-7567	★	★	—	★	★	—
CR	121	32-7352	32-7567	★	★	4-8 mfd—350v	32-1538	★	—
	122	32-7352	32-7567	★	★	4-8 mfd—350v	32-1538	★	—
CT2	—	32-7315	★	★	33-5088	4-8 mfd—350v	32-1538	★	—
HT2	—	32-7315	★	★	33-5088	4-8 mfd—350v	32-1538	★	—
RT3	—	32-7352	★	★	★	4-8 mfd—350v	32-1538	★	—
ST3	—	32-7352	★	★	★	4-8 mfd—350v	32-1538	★	—
CT5	—	32-7315	★	★	33-5088	4-8 mfd—350v	32-1538	★	—
PT5	—	32-7315	★	★	33-5088	4-8 mfd—350v	32-1538	★	—
FT6	—	32-7352	32-7567	★	33-5067	4-8 mfd—350v	32-1538	★	—
NT7	—	32-7352	32-7567	★	33-5067	4-8 mfd—350v	32-1621	★	—
ST7	—	32-7352	32-7567	★	★	8-4 mfd—350v	32-1621	★	—
NT8	—	32-7352	32-7567	★	★	8-4 mfd—350v	32-1621	★	—
FT9	—	32-7352	32-7567	★	33-5121	4-8 mfd—350v	★	32-1929	—
CT10	—	32-7352	★	★	33-5121	4-8 mfd—350v	★	32-1929	—
CT11	—	32-7352	★	★	33-5121	4-8 mfd—350v	32-2252	32-2164	—
HT-11X	—	32-7352	★	★	33-5121	4-8 mfd—350v	★	32-1929	—

*Order by Model and Code Numbers. Substitute will be supplied.



REPLACEMENT PARTS LISTING—AUTO RADIOS (Cont.)

MODEL	CODE	POWER TRANSFORMER	OUTPUT TRANSFORMER	SPEAKER	VOLUME CONTROL	FILTER CONDENSER	1st	I-F TRANSFORMER 2nd	3rd
NT-12X	—	32-7352	★	★	33-5121	4-8 mfd—350v	32-2252	32-2027	—
ST12	—	32-7352	★	★	33-5121	4-8 mfd—350v	32-2252	32-2027	—
PT14 (OS)	—	32-7352	★	★	33-5121	4-8 mfd—350v	★	32-1929	—
PT14 (DS)	—	32-7352	★	★	33-5121	4-8 mfd—350v	★	32-1929	—
RT14X	—	32-7352	★	★	33-5121	4-8 mfd—350v	★	32-1929	—
LT-14X3	—	32-7352	★	★	33-5121	4-8 mfd—350v	★	32-1929	—
MT-14X4	—	32-7352	★	★	33-5121	4-8 mfd—350v	★	32-1929	—
NT-15	—	32-7352	★	★	33-5121	4-4 mfd—350v	32-2252	32-2027	—
ST-15	—	32-7352	★	★	33-5121	4-4 mfd—350v	32-2252	32-2027	—
R1415	—	★	★	★	33-5121	4-8 mfd—350v	32-2026	32-2027	—
S1416	—	★	★	★	33-5121	4-8 mfd—350v	32-2026	32-2027	—
P1417	—	★	★	★	33-5121	4-8 mfd—350v	32-2026	32-2027	—
G1418	—	★	★	★	33-5121	4-8 mfd—350v	32-2026	32-2027	—
N1418	—	★	★	★	33-5121	4-8 mfd—350v	32-2026	32-2027	—
W1419	—	★	★	★	33-5121	4-8 mfd—350v	32-2026	32-2027	—
L1420	—	65-0095	32-7829	★	33-5121	4-8 mfd—350v	32-2286	32-2027	—
P1421	—	★	32-7078	★	★	4-8 mfd—350v	32-2252	32-2027	—
P1422	—	★	32-7078	★	★	4-8 mfd—350v	32-2252	32-2027	—

*Order by Model and Code Numbers. Substitute will be supplied.



REPLACEMENT PARTS LISTING—AUTO RADIOS (Cont.)

MODEL	CODE	POWER TRANSFORMER	OUTPUT TRANSFORMER	SPEAKER	VOLUME CONTROL	FILTER CONDENSER	I-F TRANSFORMER		
							1st	2nd	3rd
C1423	—	65-0095	32-7634	★	33-5121	4-8 mfd—350v	32-2286	32-2027	—
L1424	—	65-0095	32-7829	★	33-5121	4-8 mfd—350v	32-2286	32-2027	—
L1425	—	65-0095	★	★	33-5121	4-8 mfd—350v	32-2286	32-2027	—
P1426	—	65-0095	32-7829	★	★	4-8 mfd—350v	32-2286	32-2027	—
L1427	—	65-0095	32-7829	★	33-5121	4-8 mfd—350v	32-2286	32-2027	—
L1429	—	65-0095	★	★	33-5121	4-8 mfd—350v	32-2286	32-2027	—
P1430	—	65-0095	32-7562	★	33-5121	4-8 mfd—350v	32-2286	32-2027	—
S1431	—	65-0095	★	★	33-5121	4-8 mfd—350v	32-2286	32-2027	—
P1432	—	65-0095	★	★	33-5121	4-8 mfd—350v	32-2286	32-2027	—
N1433	—	65-0095	★	★	33-5121	4-8 mfd—350v	32-2286	32-2027	—
N1434	—	65-0095	★	★	33-5121	4-8 mfd—350v	32-2286	32-2027	—
G1436	—	65-0095	★	★	33-5121	4-8 mfd—350v	32-2286	32-2027	—
S1437	—	65-0095	★	★	33-5121	4-8 mfd—350v	32-2286	32-2027	—
F1440	—	65-0095	★	★	33-5121	4-8 mfd—350v	32-2286	32-2027	—
F1440X	—	65-0095	★	★	33-5121	4-8 mfd—350v	32-2286	32-2027	—
F1442	—	65-0095	★	★	33-5121	4-8 mfd—350v	32-2286	32-2027	—
F1442X	—	65-0095	★	★	33-5121	4-8 mfd—350v	32-2286	32-2027	—
C1450	—	65-0095	★	★	33-5121	4-8 mfd—350v	32-2286	32-2027	—

*Order by Model and Code Numbers. Substitute will be supplied.



REPLACEMENT PARTS LISTING—AUTO RADIOS (Cont.)

MODEL	CODE	POWER TRANSFORMER	OUTPUT TRANSFORMER	SPEAKER	VOLUME CONTROL	FILTER CONDENSER	I-F TRANSFORMER		
							1st	2nd	3rd
C1452	—	65-0095	★	★	33-5121	4-8 mfd—350v	32-2286	32-2027	—
L1460	—	65-0095	32-7829	★	33-5121	4-8 mfd—350v	32-2286	32-2027	—
N1514	—	★	★	★	33-5121	4-8 mfd—350v	32-2026	32-2027	—
S1516	—	★	★	★	33-5121	4-8 mfd—350v	32-2026	32-2027	—
P1517	—	★	★	★	33-5121	4-8 mfd—350v	32-2026	32-2027	—
N1524	—	65-0046	32-7928	★	★	8-4 mfd—350v	32-2791	32-2793	—
S1526	—	65-0046	32-7928	★	33-5251	8-4 mfd—350v	32-2791	32-2793	—
G1528	—	65-0046	32-7928	★	★	8-4 mfd—350v	32-2791	32-2793	—
P1530	—	65-0046	★	★	★	4-4 mfd—350v	32-2791	32-2793	—
P1535	—	65-0095	32-7829	★	33-5272	4-8 mfd—350v	★	★	—
F1540	—	32-7821	★	★	33-5272	4-8 mfd—350v	32-2286	32-2027	—
C1550	—	65-0046	★	★	33-5272	4-8 mfd—350v	32-2286	32-2027	—
L1560	—	65-0095	32-7829	★	★	4-8 mfd—350v	32-2791	32-2793	—
C1606	—	65-0152	★	★	★	5-5 mfd—300v	65-0118	★	—
C1608	—	65-0016	★	★	67-0003	4-8 mfd—350v	65-0041	65-0043	—
S1616	—	65-0046	65-0048	★	67-0014	4-8 mfd—350v	65-0044	65-0045	—
P1617	—	65-0046	65-0048	★	67-0004	4-8 mfd—350v	65-0044	65-0045	—
S1622	—	65-0152	65-0162	★	67-0015	5-10 mfd—300v 20 mfd—25v	65-0148	65-0149	—

*Order by Model and Code Numbers. Substitute will be supplied.



REPLACEMENT PARTS LISTING—AUTO RADIOS (Cont.)

MODEL	CODE	POWER TRANSFORMER	OUTPUT TRANSFORMER	SPEAKER	VOLUME CONTROL	FILTER CONDENSER	I-F TRANSFORMER		
							1st	2nd	3rd
S1626	—	65-0016	65-0053	★	67-0014	4-8 mfd—350v	65-0002	65-0003	—
G1628	—	65-0016	65-0053	★	67-0014	4-8 mfd—350v	65-0002	65-0003	—
P1630	—	65-0016	65-0024	★	67-0002	4-8 mfd—350v 10 mfd—50v	65-0002	65-0003	—
P1635	—	65-0095	32-7829	★	67-0014	4-8 mfd—350v 10 mfd—50v	65-0002	65-0003	—
F1640	—	65-0016	65-0077	★	67-0008	10-10 mfd—350v 20 mfd—25v	65-0002	65-0003	—
F1641	—	65-0179	★	★	67-0026	20 mfd—25v 10-10 mfd—350v	65-0177	65-0178	—
L1660	—	65-0016	65-0024	★	33-5410	4-8 mfd—350v	65-0002	65-0003	—
S1722	—	65-0404	65-0221	★	67-0027	20 mfd—25v 20-10 mfd—200v	65-0148	65-0214	Automatic
S1726	—	65-0234	65-0277	★	67-0027	20 mfd—25v 10-15 mfd—350v	65-0274	65-0275	—
F1740	—	65-0278	65-0277	★	67-0028	20 mfd—50v 10-15 mfd—350v	65-0265	65-0264	Manual Scale PB
L1760	—	65-0278	65-0354	★	67-0026	20 mfd—50v 10-20 mfd—350v	65-0303	65-0304	—
L1761	—	65-0278	65-0354	★	67-0026	20 mfd—50v 10-20 mfd—350v	65-0303	65-0304	—
C1708	—	65-0234	★	★	67-0020	20 mfd—50v 20-10 mfd—350v	65-0236	65-0237	—
C1808	—	65-0347	65-0363	36-1609-3	67-0040	20 mfd—50v 5-20-10 mfd— 350v	65-0365	65-0366	—

*Order by Model and Code Numbers. Substitute will be supplied.



REPLACEMENT PARTS LISTING—AUTO RADIOS (Cont.)

MODEL	CODE	POWER TRANSFORMER	OUTPUT TRANSFORMER	SPEAKER	VOLUME CONTROL	FILTER CONDENSER	1st	I-F TRANSFORMER 2nd	3rd
C1809	—	65-0347	65-0363	36-1609-3	67-0040	20 mfd—50v 10-20 mfd—350v	65-0365	65-0366	—
F1840	—	65-0347	65-0391	36-1609-3	67-0042	20 mfd—50v 15-10 mfd—350v	65-0386	65-0387	—
F1841	—	65-0347	65-0391	36-1609-3	67-0042	20 mfd—50v 15-10 mfd—350v	65-0386	65-0387	—
P1830	—	65-0347		36-1609-3	67-0047	20 mfd—50v 20-10 mfd—350v	65-0460	65-0410	—
P1835	—	65-0347	65-0354	73-0056	67-0035	20 mfd— 50v 5-20-10 mfd—350v	65-0460	65-0353	—
S1824	—	65-0404	65-0395	36-1609-3	67-0054	20 mfd— 50v 20-10 mfd—350v	65-0399	65-0400	—
S1825	—	65-0347	65-0364	36-1609-3	67-0054	20 mfd— 50v 20-10 mfd—350v	65-0460	65-0353	—
S1826	—	65-0358	65-0409	73-0066	67-0054	20 mfd— 50v 5-20-10 mfd—350v	65-0460	65-0410	—
C1908	—	65-0347	65-0363	36-1609-3	67-0040	10 mfd— 50v 5-20-10 mfd—350v	65-0365	65-0366	—
S1924	—	65-0404	65-0395	36-1609-3	67-0054	20 mfd— 50v 5-20-10 mfd—350v	65-0399	65-0400	—
S1925	—	65-0464	65-0395	36-1609-3	67-0059	5-20-10 mfd—350v 10 mfd— 25v	65-0460	65-0453	—
S1926	—	65-0347	65-0364	36-1609-3	67-0056	20 mfd— 50v 5-20-10 mfd—350v	65-0460	65-0448	—
S1927	—	65-0358	65-0409	36-1609-3	67-0058	20-10 mfd—350v 5 mfd—300v 5 mfd—300v	65-0460	65-0448	—
P1935	—	65-0358	65-0409	73-0066	67-0052	20 mfd— 50v 5-20-10 mfd—350v	65-0460	65-0410	—

*Order by Model and Code Numbers. Substitute will be supplied.

PARTS LIST



Use Genuine
PHILCO
PARTS

REPLACEMENT PARTS LISTING—AUTO RADIOS (Cont.)

MODEL	CODE	POWER TRANSFORMER	OUTPUT TRANSFORMER	SPEAKER	VOLUME CONTROL	FILTER CONDENSER	1st	I-F TRANSFORMER 2nd	3rd
F1942	—	65-0455	65-0391	73-0055	67-0060	20 mfd— 50v 15-10 mfd—350v	65-0460	65-0461	—
UN6-100	121	65-0404	32-8296-5	73-0027	67-0020	10 mfd—200v 10 mfd—150v 20 mfd— 25v	65-0399	65-0192	—
UN6-400	121	65-0234	65-0277	73-0059	67-0043	15-10 mfd—350v 20 mfd— 25v	65-0319	65-0366	—
UN6-450	121	65-0234	65-0408	73-0047	67-0032	15-10 mfd—350v 20 mfd— 25v	65-0319	65-0366	—
UN6-500	121	65-0234	65-0277	73-0059	67-0043	15-10 mfd—350v 20 mfd— 25v	65-0319	65-0366	—
UN6-550	121	65-0234	65-0408	73-0047	67-0032	15-10 mfd—350v 20 mfd—25v	65-0319	65-0366	—
CR2	121	65-0404	32-8296-5	73-0027	67-0042	10 mfd—200v 10 mfd—150v 20 mfd— 25v	65-0399	65-0192	—
CR4	121	32-8313	32-8315	36-1613	33-5557 33-5557-1 (Buick)	15-10 mfd—350v 20 mfd— 25v	32-4160	32-4161	—
CR6	121	32-8313	32-8315	36-1609-3	33-5557 33-5557-1 (Buick)	15-10 mfd—350v 20 mfd— 25v	32-4160	32-4161	—
CR8	121	32-8313	32-8315	36-1609-6	33-5557 33-5557-1 (Buick)	15-10 mfd—350v 20 mfd— 25v	32-4160	32-4161	—
CR9	* 121	32-8314-2	65-0317	36-1622-1	33-5557-3	15-10 mfd—350v 20 mfd— 25v	32-4160	32-4240	—
CR10	121	32-8313	32-8315	36-1609-12	33-5557	20 mfd— 25v 15-10 mfd—350v	32-4160	32-4161	—
CR11	121	32-8314-2	65-0317	36-1622-1	33-5557	15-10 mfd—350v 20 mfd— 25v	32-4160	32-4240	—
CR12	121	32-8314	32-8316	36-1609-2	33-5557 33-5557-1 (Buick)	20-10 mfd—350v 5 mfd—300v 10 mfd— 25v	32-4160	32-4161	—

*Order by Model and Code Numbers. Substitute will be supplied.



REPLACEMENT PARTS LISTING—AUTO RADIOS (Cont.)

MODEL	CODE	POWER TRANSFORMER	OUTPUT TRANSFORMER	SPEAKER	VOLUME CONTROL	FILTER CONDENSER	I-F TRANSFORMER		
							1st	2nd	3rd
C4608	121	65-0347	65-0363	36-1609-10	67-0040	20-10 mfd—350v 5 mfd—300v 10 mfd— 25v	65-0319	65-0366	—
	122	65-0347	32-8316-1	36-1609-10	67-0040	20-10 mfd—350v 5 mfd—300v 10 mfd— 25v	32-4160	32-4161	—
P4635	121	65-0358	65-0409	73-0066	67-0052	20-10 mfd—350v 5 mfd—300v 10 mfd— 25v	65-0460	65-0410	—
P4636	121	65-0318	65-0408	36-1622	67-0032	15-10 mfd—350v 20 mfd— 25v	65-0319	65-0366	—
P4735	121	32-8314-1	32-8325	36-1609-4	33-5557-2	20-10 mfd—350v 5 mfd—300v 10 mfd— 25v	32-4160-2	32-4161-2	—
S4624	121	65-0404	65-0395	73-0068	33-5540	20-10 mfd—350v 5 mfd—300v 10 mfd— 25v	65-0399	65-0192	—
S4625	121	65-0404	65-0395	73-0068	33-5540	20-10 mfd—350v 5 mfd—300v 10 mfd— 25v	65-0399	65-0192	—
S4626	121	65-0358	65-0409	36-1609-4	33-5522	20-10 mfd—350v 5 mfd—300v 10 mfd— 25v	65-0460	65-0410	—
S4627	121	65-0358	65-0409	36-1609-4	33-5522	20-10 mfd—350v 5 mfd—300v 10 mfd— 25v	65-0460	65-0410	—
S4824	121	65-0404	65-0395	36-1609-3	33-5556-4	20-10 mfd—350v 5 mfd—300v 10 mfd— 25v	65-0399	65-0400	—

*Order by Model and Code Numbers. Substitute will be supplied.

NOTES

PHILCO

PARTS PRICE LIST

ARRANGED ACCORDING TO
PART NUMBERS

*The following pages list all parts sold
by the Accessories Division of Philco
Corporation.*

*Included are all replacement items
listed in Philco Service bulletin and
instruction sheets.*

The sections are arranged in sequence :

- **RADIO**
- **TELEVISION**
- **REFRIGERATION**
- **AIR CONDITIONING**

RADIO PARTS PRICE LIST

PART NUMBER	LIST PRICE or Substitute	PART NUMBER	LIST PRICE or Substitute	PART NUMBER	LIST PRICE or Substitute	PART NUMBER	LIST PRICE or Substitute
2550	*32-7078	3903M	*39030SU	6009	*60-20305304	8203	*61-0122
2580	*32-7065	3903N	*39030SU	6015	*45-5012	8204	*61-0113
2646	3.50	3903ODG	.45	6021	*60-10825401	8311	*60-10305307
2660	*32-7567	39030SU	.35	6022	*60-20205304	10455A	1.50
3050A	*27-6153	3903P	*39030SU	6064	*32-7484	10457A	2.50
3076	*45-5002	3903S	*39030DG	6072	14.75	10478B	4.65
3096	*33-5026	3903SG	*61-0120	6287	*62870DU	10524D	*10524P
3116	*42-1611	3903SU	*39030SU	6287DU	*61-0113	10524P	3.75
3117	*42-1632	3903T	*39030SU	6287L	*61-0113	10524R	5.30
3164	*7696	3903W	*39030SU	6287R	*61-0113	10542D	2.95
3241	*4862	3903X	*39030SU	6287SG	*61-0113	10542E	4.20
3242	*4862	3903Y	*39030SU	6287SU	*61-0113	10542G	5.00
3253	*42-1632	3903Z	*39030SU	6287T	*61-0113	10542H	4.50
3423	*27-6153	3914	.03	6415	*45-5001	10590A	*10542D
3463	.09	3915	*3914	6417	*27-6020	10593A	6.65
3517	*6498	4042FA3	.05	6440	.15	10604C	*10455A
3528	*4056	4056	1.50	6448	.80	10605A	*10457A
3558	*5189	4093	*45-5019	6499	*45-5012	10618A	6.50
3615AX	*36150SU	4094	3.00	6508	*28-8882	10618B	6.50
3615BB	*36150SU	4169	.012	6554	*32-8227	10618C	*10618B
3615BD	*36150SU	4231	*32-7115	6556	6.50	10618D	7.30
3615BE	*36150SU	4232	*32-7828	6582	*4862	10621	15.50
3615BF	*36150SU	4446	*5594	6608	.09	10626A	†
3615BJ	*36150SU	4519	*60-10105407	6658	*32-7543	10629	*10629B
3615BP	*36150SU	4520	*60-10685401	6773	*60-20105401	10629A	*10629C
3615BR	*36150SU	4531	*45-1477	6853	*60-20205304	10629B	4.50
3615BU	*36150SU	4540	.07	6892	*45-5012	10629C	5.00
3615BX	*36150SU	4567	.09	6897	*60-00245307	10629D	5.50
3615BY	*36150SU	4587	*60-00515307	7006	*60-20275404	10630	*10630D
3615DG	*61-0170	4813	*6072	7007	*60-20155404	10630D	19.50
3615DU	*61-0170	4851	*33-1113	7128	*42-1523	10632B	†
3615E	*36150SU	4862	5.50	7139	*60-20155404	10632C	†
3615F	*36150SU	4955	*27-6153	7227	.08	10641	*10641A
3615G	*36150SU	4957	*27-6018	7239	2.25	10641A	†
3615H	*36150SU	4958	*27-4604	7296DG	*61-0062	10641E	48.00
3615J	*61-0170	4959	*27-4604	7296DU	*61-0062	10641F	†
3615K	*61-0170	4989SG	*61-0113	7296SG	*61-0062	10641G	41.00
3615ODG	*61-0122	5026	*27-6153	7296SU	*61-0062	10643C	†
36150SU	*61-0170	5048	*27-4604	7301	*60-20305304	10647A	*10647E
36155G	*61-0170	5056	3.00	7331	.07	10647E	19.00
3615M	*36150SU	5094	*27-4604	7409	.40	10647F	*10647E
3615SU	*36150SU	5117	*6072	7421	*32-7180	10647G	20.00
3675	*42-1611	5120	*60-10395407	7439	*45-5010	10651	32.00
3752	*5594	5166	*27-4604	7464	*45-3002	10651A	*10651
3773	*6498	5170	*42-1523	7465	.15	10656A	†
3790	*45-5019	5188	.70	7505	.10	10657A	†
3793AH	*3793SG	5189	.05	7544	*27-6153	10658B	†
3793AJ	*3793SG	5232	3.25	7545	*27-6153	10664A	†
3793DU	*61-0138	5262	*28-3326	7547	*27-6020	10664B	†
3793E	*61-0138	5315	*32-7828	7625DG	*45-3500-7	10664D	20.00
3793SG	.50	5316	.15	7625SG	*45-3500-7	10666	7.00
3793SU	*61-0138	5366	*45-5019	7652	*32-7865	10666A	9.50
3793Z	*3793SG	5520.8	2.25	7653SU	*61-0108	10666C	10.50
3879	*33-5060	5520.29	2.75	7696	.35	10666D	9.00
3903AB	*39030SU	5594	17.50	7762DG	*45-3500-5	10670A	†
3903AC	*61-0120	5676	.08	7776	*28-8882	10671	†
3903AD	*39030SU	5839	*45-5001	7808	*45-5012	10672B	*10672
3903AL	*39030SU	5858	*60-10245307	7828	*27-6018	10673A	16.00
3903AM	*39030SU	5863	*60-10685401	7882	.45	10674B	*10674A
3903AN	*39030SU	5867	*60-20105401	8003	*45-5013	10675	28.00
3903AP	*39030SU	5877	*60-20155404	8020.3	.50	10676	*10676A
3903AR	*39030SU	5886	*60-20125404	8046	*32-7381	10676A	†
3903AS	*39030SU	5973	.15	8054	*45-5011	10677A	†
3903DG	*61-0120	5981	*60-20625304			10677C	†
3903DU	*61-0120					10679	19.50
3903F	*39030SU					10680	34.00
3903G	*39030SU					10682	*10682A
3903H	*39030SU					10682A	†
3903J	*39030SU					10683	†
3903L	*39030SU					10683A	†

* Recommended substitute.
† Refer to distributor.

ALL PRICES SUBJECT TO CHANGE WITHOUT NOTICE

RADIO PARTS PRICE LIST—Continued

PART NUMBER	LIST PRICE or Substitute	PART NUMBER	LIST PRICE or Substitute	PART NUMBER	LIST PRICE or Substitute	PART NUMBER	LIST PRICE or Substitute
10690A	4.00	15069-1	†	06923	*27-4604	20-037011	*30-1220-14
10690B	4.00			90236	1.50	20-037017	*30-1220-14
10691	†	16595	4.80	Z-658	*76-1409	20-037511	*30-1220-14
10691A	†	16600	2.25	Z-659	*76-1410	20-040011	*60-10405237
10692	14.50	16601	3.50	PT-3	*10524P	20-042711	*30-1220-23
10693	4.50	16602	3.25	PT-4	*10524P	20-048512	*30-1220-23
10693A	6.00	16611-1	9.00	PT-6	*10524P	20-048851	*30-1220-23
10694	†	16612	6.75	PT-10	*10524P	20-048855	*30-1220-23
10695B	†	16615	8.00	PT-26	*10455A	20-050011	*30-1220-17
10697A	†	16616-1	15.00	PT-27	*10455A	20-050511	*30-1220-17
10701	†			PT-28	*10455A	20-051317	*30-1220-18
10701A	†	219024	2.40	PT-29	*10455A	20-100054	*60-20105231
10703	6.80	219036	2.40	PT-31	*10455A	20-102514	*60-20105231
10703A	5.50	219040	3.25	PT-37	*10455A	27-2140	4.00C
10703B	6.20	219041	2.50	PT-38	*10455A	27-2147	*27-8199
10703C	5.50	219047	2.00	PT-39	*10455A	27-2147	*27-4809
10703D	5.80	219048	12.50	PT-41	*10455A	27-4014	.08
10704	†	219049	6.00	PT-44	*10455A	27-4042	*27-4604
10705A	†	219053	1.10	PT-45	*10457A	27-4045	*27-4604
10705B	†	219054	2.75	PT-47	*10457A	27-4051	*27-4604
10705F	†	219055	2.50	PT-48	*10457A	27-4052	*27-4604
10706B	†	219058	3.00	PT-50	*10455A	27-4086	*27-4332
10707	20.00	219064	1.60	PT-51	*10457A	27-4099-1	.03
10708	†	219066	3.75	PT-57	*10457A	27-4099-3	.03
10709	†	219067	3.75	PT-61	*10455A	27-4102-3	6.50C
10710	3.00	219068	5.25	20-000537	*30-1223	27-4109-1	.08
10710A	3.80	219073	5.50	20-001037	*30-1223-1	27-4127	*27-4604
10711	†	219074	10.00	20-001057	*30-1223-1	27-4140	*27-4604
10711A	†	219080	4.50	20-001137	*30-1223-2	27-4206	*27-4330
10711C	†	219082	2.00	20-002577	*30-1223-5	27-4207	*27-4331
10711F	†	219083	8.25	20-006047	*60-00605237	27-4208	*27-4332
10711G	†	219085	6.25	20-007091	*60-00685237	27-4219	*27-4332
10711H	*10711M	219087	4.75	20-008007	*60-00825237	27-4233	*27-4604
10711J	†	219095	4.50	20-009807	*60-10105237	27-4234	*27-4604
10711K	†	219096	4.50	20-010011	*60-10105237	27-4235	*27-4604
10711L	†	219097	5.00	20-010091	*60-10105237	27-4246	*27-4604
10711M	†	219098	4.00	20-010411	*30-1220	27-4272	.05
10711N	†	219100	4.50	20-010417	*30-1220	27-4272-1	6.75C
10712	*76-4026	219101	5.75	20-012511	*30-1220-27	27-4275	*27-4604
10713	†	219102	4.75	20-012517	*30-1220-27	27-4278	*27-4604
10714	5.60	219109	4.00	20-013527	*30-1220-20	27-4282	*27-4604
10715	8.50	219110	6.25	20-014517	*30-1220-28	27-4284	*27-4604
10716	†	219111	7.00	20-015057	*30-1220-1	27-4291	*27-4332
10716C	†	219113	4.50	20-015094	*30-1220-1	27-4302	*27-4332
10716E	†	219116	4.50	20-015217	*30-1220-1	27-4309	.35
10717	8.20	219118	2.00	20-015317	*30-1220-29	27-4321	*27-4332
10718	†	219119	2.00	20-015517	*30-1220-29	27-4326	.15
10719	7.80	219120	.85	20-017017	*30-1220-2	27-4330	.20
10719A	7.80	219121	.85	20-018211	*30-1220-30	27-4331	.20
10720	15.30	219122	2.25	20-018511	*30-1220-30	27-4332	.15
10720A	15.30	219129	3.25	20-018517	*30-1220-30	27-4410	.15
10720B	14.00	219136	3.00	20-019017	*60-10195237	27-4411	.15
10720C	15.00	219138	5.00	20-019027	*60-10195237	27-4412	.15
10721	†	219141	3.00	20-020017	*60-10205237	27-4419	*27-4419-2
10721A	*10721C	219144	22.00	20-020517	*60-10205237	27-4419-1	*27-4419-2
10721B	†	219145	15.00	20-021011	*60-10215237	27-4419-2	.20
10721C	†	219152	.05	20-021017	*60-10215237	27-4419-3	*27-4419-2
10722	*10722B	219152-1	.05	20-023017	*30-1220-31	27-4419-4	*27-4419-2
10722A	†	02966	*45-1115	20-023517	*30-1220-31	27-4420	*27-4419-2
10722B	28.00	02987	*45-1115	20-025011	*60-10255237	27-4421	*27-4419-2
10724	*10724A	02989	*45-1115	20-025012	*60-10255237	27-4499	*55-0182
10724A	†	02993	*45-1115	20-025017	*60-10255237	27-4564	.10
10725	†	03009	*45-6365	20-025517	*60-10255237	27-4571	.04
10725A	†	03039	*45-6365	20-026517	*30-1220-5	27-4596	4.75C
10725D	†	03040	*45-6365	20-027017	*30-1220-5	27-4604	.15
10725G	†	03063	*27-4332	20-027511	*30-1220-7	27-4606	*27-4331
10726A	20.00	03064	*27-4604	20-027517	*30-1220-7	27-4610	.02
10727	†	03196	*27-4604	20-028011	*30-1220-8	27-4615	*27-4604
10728	17.00	03255	*27-4604	20-028017	*30-1220-8	27-4616	1.00
10728A	18.00	03334	*27-4604	20-028517	*30-1220-9	27-4617	.60
10729	*76-4355	03437	*27-4604	20-030017	*30-1220-10	27-4621	*27-4332
10731	†	03091	*45-6365	20-031017	*30-1220-11	27-4622	.08
10732	6.50	03092	*45-6365	20-031513	*30-1220-11	27-4632	*54-4052
10733	†	03143	*45-6365	20-032017	*30-1220-12	27-4633	*54-4052
10736	†	04339	1.20	20-032517	*30-1220-12	27-4653	*27-4604
10740	†	06100	*32-1155	20-035021	*60-10355237	27-4675	*42-5813
14876	.90	06621	*45-6365	20-035511	*60-10355237	27-4676	.02
14877	.40	03886	*45-6365	20-036011	*30-1220-21	27-4682	.80
14878	.30	05834	*45-6365	20-036017	*30-1220-21	27-4683	.03

* Recommended substitute.
† Refer to distributor.

ALL PRICES SUBJECT TO CHANGE WITHOUT NOTICE

RADIO PARTS PRICE LIST—Continued

PART NUMBER	LIST PRICE or Substitute	PART NUMBER	LIST PRICE or Substitute	PART NUMBER	LIST PRICE or Substitute	PART NUMBER	LIST PRICE or Substitute
27-4685	*27-4332	27-4985	*54-4038	27-5635	.90	27-5849	.60
27-4687-2	.40	27-4987	*27-4604	27-5636	.50	27-5863	1.50
27-4687-3	.30	27-4991	*54-4009	27-5639	.60	27-5874	*76-1537
27-4687-4	.15	27-5007	*27-7933	27-5642	.90	27-5883-1	*27-5883
27-4687-5	.10	27-5011	1.00	27-5649	*27-5678	27-5889	*27-5996-1
27-4687-6	.50	27-5038	.45	27-5651	*27-5653	27-5890	.85
27-4687-8	.50	27-5057	*31-1234	27-5653	.75	27-5891	.25
27-4701	*27-4824	27-5064	*31-1363	27-5654	.75	27-5895	1.10
27-4702	*27-4824	27-5068	*31-1408	27-5655	1.50	27-5897	.40
27-4707	.03	27-5105	.60	27-5657	.60	27-5898	.40
27-4737	*27-4604	27-5107	1.50	27-5658	2.00	27-5900	.30
27-4743	.06	27-5113	*27-5115	27-5663	*27-5682	27-5901	.35
27-4749	.10	27-5115	.60	27-5667	.65	27-5901-1	.50
27-4750	.50	27-5206	.45	27-5668	.75	27-5901-2	.35
27-4759	.20	27-5212	*27-5248	27-5678	.90	27-5901-3	.35
27-4764	*54-4027	27-5213	1.00	27-5679	*27-5907	27-5905	.30
27-4765	*54-4150	27-5243	*27-5280	27-5682	.90	27-5907	1.00
27-4766	.45	27-5248	.75	27-5684	.75	27-5908	1.00
27-4767	.20	27-5271	1.50	27-5690	1.50	27-5913	.55
27-4771-1	2.50 C	27-5275	*45-2401	27-5691	.90	27-5916	-3.40
27-4777	.15	27-5280	.60	27-5692	.75	27-5916-2	-3.75
27-4781	.15	27-5283	2.25	27-5693	.75	27-5918	1.00
27-4782	*27-4824	27-5284	*27-5285	27-5694	1.50	27-5922	.45
27-4783	*27-4824	27-5285	.75	27-5695	*27-5908	27-5923	.30
27-4784	*27-4824	27-5287	.60	27-5701	*27-5678	27-5928	1.00
27-4786	.15	27-5327	.90	27-5703	1.25	27-5929	.90
27-4787	.15	27-5333	.90	27-5704	1.80	27-5935-1	1.00
27-4788	.10	27-5335	*27-5327	27-5713	.75	27-5939	1.30
27-4792	2.25	27-5337	*27-5356	27-5714	1.10	27-5940	1.00
27-4798	*27-4766	27-5338	*27-5357	27-5716	1.50	27-5943	.50
27-4802	*54-4027	27-5340	3.50	27-5717	1.50	27-5948	5.00
27-4805	.20	27-5345	*31-2107	27-5729	.75	27-5949	9.00
27-4809	.15	27-5356	1.75	27-5730	.60	27-5950	.60
27-4810	*27-4809	27-5357	1.75	27-5731	1.50	27-5951	1.25
27-4811	*27-4824	27-5403	.60	27-5732	.75	27-5951-1	1.25
27-4815	*27-3820	27-5406	.60	27-5733	.75	27-5952	.60
27-4815-1	.15	27-5421	1.50	27-5734	1.50	27-5953	.75
27-4815-2	.10	27-5422	2.00	27-5735	.75	27-5924	1.50
27-4816	.45	27-5426	.60	27-5736	1.50	27-5954-1	1.50
27-4817	2.50 C	27-5435	*31-2321	27-5737	.01	27-5954-2	1.00
27-4820	.15	27-5438	1.80	27-5744	1.80	27-5955	.65
27-4824	.15	27-5448	1.80	27-5745	1.50	27-5956	.25
27-4829	*27-4820	27-5449	.60	27-5751	1.85	27-5957	.50
27-4831	*27-4824	27-5469	1.80	27-5752	1.50	21-5958	.50
27-4832	1.85	27-5472	.45	27-5753	1.50	27-5959	.25
27-4843	.30	27-5506	.60	27-5754	1.10	27-5962	.40
27-4845	*27-4891	27-5507	.60	27-5755	1.50	27-5964	.60
27-4848	*27-4876	27-5508	1.50	27-5757	1.10	27-5965	.30
27-4852	*54-4009	27-5513	1.50	27-5758	1.10	27-5965-1	.60
27-4862	*27-4331	27-5516	.60	27-5759	1.50	27-5966	1.10
27-4866	*54-4009	27-5517	.90	27-5760	1.85	27-5968	1.20
27-4868	*27-4891	27-5519	*27-5516	27-5762	1.10	27-5968-1	1.45
27-4874	*27-4876	27-5537	1.50	27-5777	1.10	27-5969	1.50
27-4876	.20	27-5541	*27-5472	27-5781	1.10	27-5970	.50
27-4891	.10	27-5542	.75	27-5788	1.10	27-5972	1.85
27-4891-1	.20	27-5552	*27-5507	27-5789	1.50	27-5974	1.50
27-4896	*27-4820	27-5553	.75	27-5790	*27-5760	27-5975	1.35
27-4899	*27-4820	27-5554	.75	27-5793	1.50	27-5976	.75
27-4905	*27-4876	27-5556	1.50	27-5794	1.50	27-5977	.30
27-4906	*27-4820	27-5560	*27-5554	27-5797	.75	27-5978	.35
27-4911	.50	27-5566	.90	27-5798	1.10	27-5978-2	.45
27-4914	*27-4816	27-5569	1.00	27-5800	1.10	27-5979-1	*76-3187-6
27-4924	*27-4876	27-5570	*27-5554	27-5801	1.50	27-5982	.50
27-4927	.15	27-5571	3.25	27-5802	.75	27-5983	.35
27-4937	*27-4820	27-5572	.50	27-5803	1.85	27-5984-1	3.00
27-4938	*27-4820	27-5573	*27-5554	27-5810	1.10	27-5985	.50
27-4940	*27-4820	27-5583	1.80	27-5811	1.10	27-5986	.75
27-4942	*27-4820	27-5587	*27-5717	27-5812	1.10	27-5987	.60
27-4950	*27-4809	27-5588	*27-5554	27-5817	.75	27-5994	.85
27-4952	*27-4824	27-5590	.60	27-5824	1.85	27-5995	1.60
27-4953	.45	27-5591	.60	27-5825	.75	27-5996-1	1.50
27-4963	1.85	27-5592	*27-5591	27-5826	1.50	27-5997	.50
27-4965	1.50	27-5606	*27-5655	27-5827	1.10	27-5998	.90
27-4970	*27-4876	27-5607	*27-5658	27-5836	.75	27-5999	1.00
27-4971	*27-4820	27-5610	.25	27-5839	.50	27-5999-1	.60
27-4972	*27-4891	27-5616	.40	27-5840	.30	27-6005	*27-6047
27-4975	2.25	27-5617	*27-5653	27-5842	.80	27-6006	*27-6153
27-4981	.03	27-5618	*27-5654	27-5843	3.25	27-6007	*27-6047
27-4983	1.10	27-5619	.50	27-5845	.90	27-6009	*27-6047
27-4984	*27-4767	27-5621	.90	27-5846	*45-1570-1	27-6012	*27-6047

* Recommended substitute.

ALL PRICES SUBJECT TO CHANGE WITHOUT NOTICE

RADIO PARTS PRICE LIST—Continued

PART NUMBER	LIST PRICE or Substitute	PART NUMBER	LIST PRICE or Substitute	PART NUMBER	LIST PRICE or Substitute	PART NUMBER	LIST PRICE or Substitute
27-6014	*27-6167	27-6182	.15	27-9432	1.00C	28-5990FE12	.01
27-6015	*27-6153	27-6183	.30	27-9436	.07	28-5998	.30
27-6018	.25	27-6186	.10	27-9437	5.00C	28-6094	.02
27-6020	*27-6068	27-6198	.15	27-9439	.08	28-6161	.08
27-6025	*27-6182	27-6199	.25	27-9454	.05	28-6374	.06
27-6030	.12	27-6200	.12	27-9467	.05	28-6469	.45
27-6033	*27-6018	27-6203	.17	27-9468	.05	28-6500	*38-8060
27-6034	*27-6153	27-6203-1	.25	27-9498	.08	28-6558	.40
27-6035	*27-6167	27-6203-3	.60	27-9508	5.00C	28-6916	*56-6100
27-6036	*27-6168	27-6203-4	.70	27-9509	.05	28-6936	1.50
27-6037	*27-6047	27-6203-5	.40	27-9511	.15	28-7033	.75
27-6042	*27-6153	27-6203-6	.50	27-9647	.05	28-7120	*31-1600
27-6043	*27-6018	27-6203-10	.45	27-9657	.05	28-7121	*31-1626
27-6044	*27-6153	27-6203-11	.45	27-9671	.08	28-7152	.15
27-6047	.12	27-6207	.25	27-9677	.08	28-7185	.15
27-6052	.15	27-6207-1	.25	27-9679	.08	28-7187	.18
27-6053	*27-6058	27-6209	.15	27-9705	2.00C	28-7190	*45-2329
27-6057	*27-6058	27-6210	.35	27-9800	.30	28-7197	*45-2324
27-6058	.15	21-6211	.35	27-9816	.30	28-7316	*28-7334FC56
27-6063	*27-6058	27-6211-1	.35	27-9816-1	5.00C	28-7334	*28-7334FC56
27-6080	*27-6030	27-6213	.25	27-9817	.20	28-7334FC56	2.25
27-6085	*27-6058	27-6214	.15	27-9822	.08	28-8009	.01
27-6086	*27-6058	27-6214-1	.12	27-9870	.15	28-8245	.03
27-6087	*27-6058	27-6214-6	.20	27-9879	.40	28-8260	1.75
27-6090	*27-6153	27-6214-7	.12	27-9879-1	.25	28-8496	.08
27-6098	.15	27-6217	.12	27-9897	4.50C	28-8499	*28-8599
27-6099	*27-6058	27-6222	.35	27-9922	.30	28-8599	1.50
27-6103	*55-0945	27-6226	.25	27-9939	.12	28-8610	.05
27-6107	*27-6047	27-6227	.30	28-1269	.04	28-8658	4.50C
27-6108	*27-6128	27-6229	.35	28-1270	.03	28-8675	1.35
27-6110	.20	27-6231-3	.20	28-1272	.02	28-8711	3.00C
27-6111	.20	27-6233	.40	28-1331	.60	28-8751	.08
27-6112	.20	27-6233-1	.40	28-1582	.02	28-8841	1.50C
27-6114	.45	27-6233-2	.30	28-1583	*1W56289FA3	28-8882	.08
27-6119	*27-6153	27-6233-3	.40	28-1644FA3	1.10C	28-8908	1.50C
27-6120	*27-6058	27-6233-4	.20	28-1738	.02	28-8913	.08
27-6121	*27-6058	27-6233-6	.60	28-2043	.02	28-8919	.06
27-6123	*27-6168	27-6233-7	.40	28-2214FA5	.004	28-8933	.20
27-6124	*27-6167	27-6233-8	.15	28-2225	*28-2725	28-8934	.15
27-6126	.10	27-6233-9	.45	28-22571FA3	.05	28-8936	.20
27-6127	.20	27-6233-10	.70	28-2258FA3	5.00C	28-8945	.08
27-6128	.10	27-6233-11	*76-2728-5	28-2488	.01	28-8953	3.00C
27-6129	*27-6128	27-6233-12	.40	28-2669FA43	2.00C	28-8954	.05
27-6130	*27-6128	27-6233-14	.50	28-2726	.10	28-8962	.05
27-6132	.35	27-6233-16	.20	28-3245	.35	28-8968	.05
27-6137	*27-6138	27-6233-17	.50	28-3245	.08	28-8970	1.50C
27-6138	.15	27-6233-18	.30	28-3326	.01	28-8991	.05
27-6143	.15	27-6233-19	.45	28-3445	1.50C	28-8999	.20
27-6144	*27-6210	27-6233-20	.15	28-3584	.15	28-9000	.08
27-6145	.15	27-6233-21	1.30	28-3757	*28-3757-1	28-9001	.15
27-6146	.40	27-6233-22	.25	28-3757-1	1.80	28-9003	.08
27-6147	.45	27-6233-23	.20	28-3758	*28-3758-1	28-9007	4.50C
27-6148	.45	27-6233-25	.30	28-3758-1	2.25	28-9010FA1	8.00C
27-6149	*27-6186	27-6234	.50	28-3806	1W2981-4FA3	28-9010FA38	*28-9010FA1
27-6150	*27-6156	27-6234-1	.40	28-3888FA5	.04	28-9011FA3	.05
27-6151	*27-6138	27-6240	.30	28-4074	*45-2324	30-1000	*60-10395407
27-6153	.10	27-6245	.20	28-4097	*45-2429	30-1001	*60-20625304
27-6155	.30	27-6876	1.00	28-4110	*45-2429	30-1002	*60-20625304
27-6156	.15	27-6883	1.50	28-4117	.01	30-1004	*60-10335407
27-6157	*27-6128	27-7059	*45-2610	28-4186	.01	30-1005	*60-10105407
27-6158	*27-6128	27-7131	*27-7729	28-4279	.01	30-1006	*60-10105407
27-6158-2	*27-6128	27-7132	.40C	28-4342FA3	.02	30-1007	*60-20105401
27-6159	*27-6128	27-7133	.05	28-4342FE3	1.00C	30-1008	*60-00305307
27-6160	*27-6138	27-7194	.03	28-4468	.08	30-1010	*60-00685407
27-6162	*27-6156	27-7467	1.50C	28-4522-1	5.50C	30-1011	*60-00825307
27-6163	*27-6058	27-7729	1.80	28-4696	.15	30-1012	*60-00105407
27-6164	*27-6156	27-7900	.05	28-4843	*5973	30-1013	*60-10205307
27-6166	.15	27-7933	.02	28-5002FA1	3.00C	30-1014	*60-10395407
27-6167	.15	27-8053	6.00	28-5003FA1	.04	30-1015	*60-10915301
27-6168	.15	27-8199	.08	28-5254	.04	30-1016	*60-20395404
27-6173	*27-6058	27-8351	*45-2350	28-5361	.04	30-1017	*60-20515304
27-6174	.15	27-8819	.05	28-5515	.15	30-1019	*60-30103404
27-6174-2	.25	27-9049	2.50C	28-5583	*57-1669	30-1026	*60-20245304
27-6174-4	.25	27-9284	.08	28-5608	.02	30-1027	*60-10395407
27-6177	.25	27-9299	*27-9511	28-5609	.02	30-1029	*60-00515307
27-6178	*27-6138	27-9319	*45-1459	28-5610	.08	30-1030	*60-00155407
27-6179	.20	27-9327	*27-9511	28-5665FA3	.02	30-1031	*60-10105407
27-6180	.10	27-9336	.08	28-5814FA1	.05	30-1032	*60-10245307
27-6181	.20	27-9382	2.25C	28-5897	.02	30-1033	*60-10155407
		27-9399	.10	28-5941	.15	30-1035	*60-10105407

* Recommended substitute.

ALL PRICES SUBJECT TO CHANGE WITHOUT NOTICE

RADIO PARTS PRICE LIST—Continued

PART NUMBER	LIST PRICE or Substitute	PART NUMBER	LIST PRICE or Substitute	PART NUMBER	LIST PRICE or Substitute	PART NUMBER	LIST PRICE or Substitute
30-1036	*60-10105407	30-1132	*60-00395407	30-1220-32	.70	30-2012	*45-3018-27
30-1039	*60-00305307	30-1134	*60-20515304	30-1220-33	.70	30-2013	*45-3005-7
30-1040	*60-00625307	30-1135	*60-10825401	30-1220-34	.50	30-2028	*45-3003
30-1041	*60-10155407	30-1136	*60-10685401	30-1220-35	.50	30-2033	*45-3002
30-1042	*60-20205304	30-1137	*60-00245307	30-1220-37	.50	30-2035	*45-3002
30-1043	*60-20625304	30-1138	*30-1220-17	30-1220-41	.45	30-2038	*45-3002
30-1044	*60-00365307	30-1139	*30-1223-3	30-1220-43	.45	30-2041	*45-3018-27
30-1046	*60-00825307	30-1140	*60-20125404	30-1220-44	.50	30-2043	*45-3002
30-1047	*60-10205307	30-1141	*60-00365307	30-1220-47	.70	30-2045	*45-3003
30-1048	*60-00365307	30-1142	*60-10515307	30-1220-49	.30	30-2046	*45-3005-9
30-1049	*60-10625301	30-1143	*60-90505007	30-1220-50	.30	30-2055	*45-3018-27
30-1050	*60-10135307	30-1145	*30-1223-5	30-1220-51	.45	30-2060	*45-3009
30-1051	*60-20105401	30-1150	*60-00825307	30-1220-54	.30	30-2061	*45-3009
30-1052	*60-20515304	30-1155	*60-10245307	30-1221	.08	30-2064	*45-3002
30-1054	*60-20305304	30-1156	*30-1187	30-1221-2	.10	30-2066	*45-3002
30-1055	*60-20245304	30-1157	*30-1220-14	30-1221-3	.06	30-2068	*45-3003
30-1056	*60-10245307	30-1173	*30-1223-6	30-1221-4	.08	30-2069	*45-3009
30-1057	*60-20205304	30-1174	*60-00685237	30-1221-5	.07	30-2073	3.25
30-1058	*60-20515304	30-1175	*60-10125237	30-1223	.50	30-2075	*45-3010
30-1059	*60-00305307	30-1176	*30-1220-29	30-1223-1	.55	30-2078	2.85
30-1060	*60-10915301	30-1177	*30-1220-20	30-1223-2	.30	30-2079	*45-3011
30-1061	*60-20335404	30-1178	*30-1220-2	30-1223-3	.50	30-2083	*45-3003
30-1062	*60-20155404	30-1179	*60-10255237	30-1223-4	.75	30-2085	*45-6265
30-1063	*60-20105401	30-1181	*60-00825237	30-1223-5	.75	30-2086	*45-3001
30-1064	*60-10625301	30-1182	*60-00915237	30-1223-6	.75	30-2087	*45-6265
30-1065	*60-00105407	30-1183	*30-1187	30-1223-7	.75	30-2088	*45-3018-27
30-1066	*60-00825307	30-1185	*30-1220-22	30-1224	.25	30-2089	*45-3018-27
30-1067	*60-00245307	30-1186	*60-10105237	30-1224-1	.25	30-2091	*45-3010
30-1068	*60-00685407	30-1187	.45	30-1224-2	.25	30-2092	*45-3010
30-1069	*60-10755301	30-1188	*60-00825237	30-1224-4	.30	30-2093	*45-3002
30-1071	*60-20395404	30-1191	*60-10405237	30-1224-5	.30	30-2094	*45-3009
30-1074	*60-10245307	30-1192	*30-1220	30-1224-6	.50	30-2095	*45-3009
30-1076	*60-00625307	30-1193	*60-00915237	30-1224-8	.50	30-2102	*45-3003
30-1077	*60-90505007	30-1194	*60-10105237	30-1224-9	.50	30-2103	*45-6265
30-1078	*60-10205307	30-1195	*60-10405237	30-1224-13	1.25	30-2104	*45-3005-8
30-1079	*60-00155407	30-1196	*30-1220-5	30-1224-14	.25	30-2117	*45-3010
30-1080	*60-00155407	30-1197	*30-1220-30	30-1224-15	1.00	30-2118	*45-3003
30-1081	*60-20125404	30-1198	*30-1220-2	30-1224-16	.25	30-2123	*45-3009-5
30-1082	*60-00825307	30-1200	*30-1220-7	30-1224-18	.30	30-2124	*45-3005-4
30-1083	*60-90505007	30-1201	*30-1220-11	30-1224-20	1.25	30-2128	*45-3018-30
30-1085	*60-20275404	30-1202	*60-00605237	30-1224-24	.50	30-2129	*45-3005-7A
30-1086	*60-10515307	30-1203	*30-1220-14	30-1224-26	.25	30-2131	*45-3010
30-1087	*60-10245307	30-1208	*30-1220-30	30-1224-30	.35	30-2135	*45-3003
30-1088	*60-10135307	30-1210	*60-10215237	30-1224-32	.25	30-2140	*45-3003
30-1089	*60-10395407	30-1211	*30-1220-14	30-1224-33	.50	30-2140	*45-3003-7A
30-1090	*60-00205307	30-1212	*30-1220-12	30-1224-37	.20	30-2150	*45-3005-7A
30-1091	*60-00105407	30-1213	*60-10205237	30-1225	.40	30-2160	*45-3003
30-1092	*60-10515307	30-1214	*30-1220-31	30-1225-1	.20	30-2163	*45-3005-10
30-1093	*60-10395407	30-1215	*30-1220-4	30-1225-2	.40	30-2164	*45-3002
30-1094	*60-20335404	30-1216	*30-1220-8	30-1225-4	.20	30-2166	*30-2547
30-1095	*60-00395407	30-1220	.50	30-1225-5	.35	30-2167	*45-3005-7A
30-1096	*60-20275404	30-1220-1	.50	30-1225-6	.40	30-2168	*45-3005-7A
30-1097	*60-90505007	30-1220-2	.50	30-1225-9	.20	30-2176	*45-3005-9
30-1099	*60-10245307	30-1220-3	*30-1220-4	30-1225-13	.25	30-2179	*45-3005-7A
30-1101	*60-00515307	30-1220-4	.50	30-1225-14	.20	30-2183	*45-3005-10
30-1102	*60-10105407	30-1220-5	.60	30-1225-15	.20	30-2191	*45-3002
30-1104	*60-10255237	30-1220-6	*30-1220-7	30-1225-16	.30	30-2194	*45-3010
30-1105	*60-00685407	30-1220-7	.60	30-1225-18	.30	30-2200	*45-3010
30-1106	*60-00105407	30-1220-8	.60	30-1225-19	.30	30-2201	*45-3005-9
30-1107	*60-00685407	30-1220-9	.60	30-1226	1.90	30-2203	*45-3012
30-1108	*60-00245307	30-1220-10	.40	30-1226-1	.25	30-2205	*45-3002
30-1110	*30-1220-14	30-1220-11	.45	30-1226-2	.25	30-2206	*45-3003
30-1111	*60-10405237	30-1220-12	.70	30-1226-2	1.75	30-2210	*45-3010
30-1112	*30-1223-5	30-1220-13	*30-1220-21	30-1226-3	.25	30-2212	*45-3010
30-1113	*30-1223-7	30-1220-14	.70	30-1226-4	.45	30-2217	*45-3005-7A
30-1114	*60-10515307	30-1220-15	*30-1220-22	30-1226-6	.30	30-2219	*45-6252
30-1115	*60-10205237	30-1220-16	*30-1220-23	30-1226-7	.30	30-2220	*45-3002
30-1116	*30-1220-32	30-1220-17	.70	30-1226-10	.20	30-2222	*45-3002
30-1117	*60-00685407	30-1220-18	.70	30-1226-11	.45	30-2228	*45-3004
30-1118	*60-10105407	30-1220-19	*30-1220-8	30-1226-12	.30	30-2230	*45-3005-9
30-1119	*60-10245307	30-1220-20	.50	30-1226-15	.20	30-2234	*45-3003
30-1120	*60-90505007	30-1220-21	.70	30-1226-16	.75	30-2235	*45-3010
30-1121	*30-1220-29	30-1220-22	.70	30-1226-17	.35	30-2237	*45-3005-6
30-1122	*60-10135237	30-1220-23	.45	30-1226-18	.25	30-2243	*45-3005-8
30-1123	*30-1223-4	30-1220-24	.75	30-1226-20	.25	30-2245	*45-3005-5
30-1125	*60-20205304	30-1220-26	.50	30-1229	1.30	30-2246	*45-3005-4
30-1127	*30-1220-2	30-1220-27	.50	30-1229-2	1.30	30-2256	*45-3005-6
30-1128	*60-10105407	30-1220-28	.50	30-1231	3.75	30-2259	*45-3005-10
30-1129	*60-20205304	30-1220-29	.50	30-2001	*45-3005-4	30-2265	*45-3005-8
30-1130	*60-10105407	30-1220-30	.50	30-2002	*45-3005-2	30-2271	*45-3010
30-1131	*30-1220-4	30-1220-31	.50	30-2003	*45-3002	30-2273	*45-3010

* Recommended substitute.

ALL PRICES SUBJECT TO CHANGE WITHOUT NOTICE

RADIO PARTS PRICE LIST—Continued

PART NUMBER	LIST PRICE or Substitute	PART NUMBER	LIST PRICE or Substitute	PART NUMBER	LIST PRICE or Substitute	PART NUMBER	LIST PRICE or Substitute
30-2279	*45-3014	30-2438	*45-3004	30-2550A	2.10	30-4007-1	1.00
30-2291	*45-3011	30-2445	*45-6252	30-2551	*45-3018-27	30-4012	*61-0170
30-2295	*45-3007A	30-2447	*45-3003	30-2552	2.35	30-4013	1.50
30-2311	*45-3003	30-2449	1.90	30-2552A	2.35	30-4016	*61-0122
30-2313	*45-3002	30-2452	1.90	30-2554	*45-3018-23	30-4020	*61-0170
30-2316	*45-3005-7A	30-2453	*30-2547	30-2555	1.75	30-4024	*61-0153
30-2319	*45-3010	30-2454	2.65	30-2555A	1.75	30-4025	*45-3500-1
30-2323	*45-3005-7A	30-2455	*30-2547	30-2556	2.50	30-4112	*61-0174
30-2327	*45-3005-1	30-2456	*45-3003	30-2556A	2.50	30-4114	*61-0122
30-2328	*45-3010	30-2457	*30-2547	30-2559	†	30-4115	*45-3501
30-2329	*45-3003	30-2458	*30-2547	30-2560	2.75	30-4116	*61-0125
30-2330	*45-3009	30-2459	*45-3002	30-2560-4	3.50	30-4117	*45-3500-4
30-2331	*45-3010	30-2461	*30-2520	30-2563	*30-2560	30-4119	*45-3500-2
30-2332	*45-3005-6	30-2463	*30-2506	30-2568	1.55	30-4122	*61-0113
30-2333	*45-3005-5	30-2464	*45-3003	30-2568-1	1.75	30-4123	*61-0122
30-2334	*45-3005-2	30-2465	*30-2465A	30-2568-2	*30-2435	30-4124	*61-0120
30-2335	*45-3010	30-2465A	1.55	30-2568-3	*30-2504	30-4125	*45-3500-7
30-2339	*45-3005-4	30-2466	*45-6252	30-2568-5	2.25	30-4134	*61-0125
30-2341	*45-3009	30-2468	*30-2468A	30-2568-8	1.90	30-4145	*61-0120
30-2342	*45-3010	30-2468A	1.50	30-2568-9	2.10	30-4146	*61-0125
30-2345	*45-3002	30-2469	.70	30-2568-10	2.90	30-4169	*61-0120
30-2346	*45-3002	30-2471	*45-3002	30-2568-11	2.10	30-4170	*61-0113
30-2348	*45-3003	30-2472	*45-3010	30-2568-12	3.25	30-4176	1.20
30-2349	*45-3003	30-2473	*45-3002	30-2568-13	1.50	30-4177	*61-0130
30-2351	*45-3003	30-2474	*45-3002	30-2568-14	1.90	30-4181	1.20
30-2355-2	2.50	30-2475	*30-2547	30-2568-16	2.50	30-4185	*61-0129
30-2359	*45-3002	30-2476	*45-3003	30-2568-18	2.50	30-4191	*61-0113
30-2360	*45-3005-5	30-2478	*45-3018-27	30-2568-19	2.25	30-4201	*61-0130
30-2361	*45-3001	30-2479	1.15	30-2568-20	2.50	30-4215	*61-0108
30-2363	*45-3010	30-2480	2.00	30-2568-21	3.00	30-4226	*61-0120
30-2364	*45-3010	30-2481	*45-3002	30-2568-22	1.65	30-4227	*61-0133
30-2366	*45-3005-6	30-2482	*45-3018-23	30-2568-23	1.75	30-4296	.60
30-2368	*45-3010	30-2490	*45-3015	30-2568-24	3.00	30-4307	.60
30-2373	*45-3005-6	30-2491	*30-2547	30-2568-25	3.50	30-4310	*45-3500-11
30-2380	*30-2547	30-2492	2.25	30-2568-26	3.50	30-4317	*45-3500-13
30-2382	*30-2547	30-2494	*30-2547	30-2568-28	1.75	30-4327	*61-0122
30-2383	*45-3002	30-2495	*30-2547	30-2568-32	2.15	30-4334	*61-0179
30-2386	*45-3010	30-2496	*45-3002	30-2570	2.50	30-4358	*61-0120
30-2387	*45-3005-4	30-2497	*30-2547	30-2570-1	3.50	30-4373	*61-0122
30-2388	*45-3003	30-2498	3.00	30-2570-3	3.00	30-4374	1.85
30-2391	*30-2547	30-2500	*45-3018-27	30-2570-5	3.50	30-4381	*61-0124
30-2394	*30-2547	30-2502	*45-3003	30-2570-6	3.00	30-4404	1.20
30-2396	*45-3002	30-2503	*30-2547	30-2570-8	4.00	30-4412	*61-0153
30-2401	*45-3002	30-2504	*30-2504A	30-2570-9	3.50	30-4415	1.60
30-2403	*30-2547	30-2504A	1.85	30-2570-10	3.25	30-4419	*61-0118
30-2404	*45-3009	30-2505	*45-3016	30-2570-11	3.00	30-4420	*61-0127
30-2405	*45-3010	30-2506	2.75	30-2570-12	4.00	30-4428	*45-3500-14
30-2408	*45-3003	30-2507	*45-3018-23	30-2570-13	2.50	30-4445	*45-3500-7
30-2409	*45-3002	30-2510	2.00	30-2570-14	2.10	30-4446	*61-0125
30-2410	*45-3002	30-2511	2.25	30-2570-15	2.90	30-4447	*61-0119
30-2411	*45-3002	30-2511A	2.25	30-2570-16	2.95	30-4448	*61-0125
30-2412	*45-3016	30-2512	2.85	30-2570-18	3.00	30-4449	*45-3500-1
30-2413	*45-3010	30-2512A	2.85	30-2570-20	3.00	30-4450	*30-4490
30-2415	*45-3002	30-2513	*45-3003	30-2570-24	2.50	30-4453	*61-0130
30-2417	1.10	30-2515	*30-2547	30-2570-25	1.65	30-4454	*61-0170
30-2417-1	.85	30-2516	*30-2547	30-2570-26	3.50	30-4455	*61-0113
30-2417-2	.95	30-2517	*45-3004	30-2570-28	1.75	30-4456	*61-0179
30-2417-3	1.00	30-2519	*45-3004	30-2570-30	3.00	30-4467	*45-3500-7
30-2417-6	1.25	30-2520	1.75	30-2570-31	2.75	30-4469	*61-0117
30-2417-7	1.10	30-2521	1.60	30-2570-33	2.25	30-4475	1.50
30-2417-10	2.90	30-2522	*45-3002	30-2570-34	2.00	30-4479	*61-0120
30-2417-11	1.30	30-2525	*45-3004	30-2570-35	3.50	30-4490	1.25
30-2418	*45-3018-27	30-2526	*45-3003	30-2570-36	3.25	30-4491	*61-0133
30-2419	*45-6265	30-2527	*45-3003	30-2570-37	3.00	30-4495	*61-0118
30-2420	*45-6265	30-2529	*30-2452	30-2572	1.25	30-4498	*61-0113
30-2421	*45-3018-30	30-2531	*45-3005-5	30-2573	1.90	30-4499	*61-0113
30-2422	*45-3002	30-2533	*45-3003	30-2574	*30-2573	30-4504	*45-3500-7
30-2423	*45-3002	30-2534	*30-2449	30-2575-2	2.25	30-4505	*61-0113
30-2424	*45-3018-8	30-2535	*45-3003	30-2575-9	*45-3001	30-4508	*61-0113
30-2425	*45-3002	30-2536	*45-3003	30-2575-10	2.00	30-4514	*61-0120
30-2426	*45-3002	30-2537	*30-2547	30-2575-11	1.00	30-4515	*61-0120
30-2427	*45-3015	30-2538	*30-2547	30-2575-12	2.15	30-4516	*61-0108
30-2428	*45-3002	30-2540	.75	30-2575-17	3.65	30-4517	.30
30-2429	*45-3004	30-2540-1	1.90	30-2575-20	2.00	30-4518	.25
30-2432	*45-3003	30-2541	*30-2547	30-2575-21	1.40	30-4519	*61-0122
30-2433	*30-2547	30-2543	1.90	30-2575-23	2.50	30-4520	*61-0119
30-2434	*30-2547	30-2546	*30-2559	30-2575-24	3.00	30-4525	*61-0115
30-2435	*30-2435A	30-2547	1.30	30-2575-26	3.00	30-4527	*61-0113
30-2435A	1.40	30-2548	1.10	30-2575-27	2.25	30-4528	*45-3500-4
30-2437	*30-2547	30-2550	2.10	30-2577	2.00	30-4529	*61-0120

* Recommended substitute.

† Refer to distributor.

ALL PRICES SUBJECT TO CHANGE WITHOUT NOTICE

RADIO PARTS PRICE LIST—Continued

PART NUMBER	LIST PRICE or Substitute	PART NUMBER	LIST PRICE or Substitute	PART NUMBER	LIST PRICE or Substitute	PART NUMBER	LIST PRICE or Substitute
30-4530	*61-0113	31-1584	*31-1563	31-2558	4.00	31-2727-4	4.20
30-4536	*45-3500-3	31-1600	.20	31-2561	5.00	31-2727-5	4.25
30-4552	*61-0138	31-1631	*31-1643	31-2562	.35	31-2727-6	4.00
30-4555	*45-3500-6	31-1643	.80	31-2564	4.00	31-2728	7.50
30-4557	2.00	31-1645	*31-1555	31-2566	.70	31-2729	9.50
30-4560	*61-0126	31-1671	*31-1555	31-2567	4.00	31-2730	.50
30-4565	*61-0133	31-1681	*31-1555	31-2568	.75	31-2731	4.00
30-4567	*61-0127	31-1746	*31-1555	31-2571	.80	31-2733	8.00
30-4569	*61-0122	31-1817	1.10	31-2578	4.00	31-2735	4.25
30-4571	*61-0113	31-1844	.50	31-2579	5.50	31-2736	*31-2724-6
30-4572	.30	31-1871	{lea45-2378 lea28-5361	31-2581	5.00	31-2738	.50
30-4575	*61-0122		1.00	31-2583	*31-2675	31-2738-1	.75
30-4578	*61-0179	31-1879	1.00	31-2584	1.00	31-2739	9.00
30-4579	*61-0062	31-1884	.40	31-2589	.50	31-6100	.60
30-4580	*61-0109	31-1898	2.50	31-2591	.80	31-6111	2.25
30-4581	*61-0120	31-1907	*31-1961	41-2592	5.50	31-6161	.45
30-4582	*61-0109	31-1961	1.20	31-2595	5.50	31-6165	*31-6161
30-4583	*45-3500-7	31-2089	1.50	31-2596	7.00	31-6188	.75
30-4584	*61-0108	31-2265	5.00	31-2600	7.00	31-6209	*31-6100
30-4585	*45-3500-1	31-2281	.65	31-2605	5.50	31-6258	1.10
30-4586	*61-0113	31-2283	*27-5406	31-2626	.40	31-6298	.90
30-4587	*45-3500-3	31-2291	2.00	31-2636	4.75	31-6308	.25
30-4588	*61-0125	31-2300	4.50	31-2638-1	6.00	31-6350	.70
30-4589	*61-0125	31-2306	*27-5420	31-2640	1.00	31-6372	3.50
30-4590	*61-0133	31-2321	.80	31-2641	4.25	31-6378	1.10
30-4591	*45-3500-7	31-2329	2.60	31-2642-1	11.00	31-6391	.50
30-4592	*45-3500-5	31-2334	*27-5426	31-2654	4.00	31-6401	.80
30-4593	*61-0113	31-2335	4.25	31-2658	4.75	31-6410	.40
30-4594	*45-3500-3	31-2340	*27-5449	31-2659	7.50	31-6411	.90
30-4597	*61-0062	31-2354	5.50	31-2663	.70	31-6412	.75
30-4598	*61-0124	31-2355	.30	31-2664	.85	31-6413	.40
30-4598	*61-0108	31-2370	.75	31-2675	5.00	31-6414	3.10
30-4600	*61-0113	31-2395	.30	31-2680	.80	31-6414-1	2.90
30-4601	*45-3500-11	31-2425	4.25	31-2689	5.25	31-6414-2	1.90
30-4602	*61-0170	31-2427	*31-2447	31-2690	4.75	31-6414-3	3.00
30-4604	*61-0125	31-2429	4.00	31-2692	5.50	31-6414-4	2.25
30-4608	*61-0115	31-2431	4.00	31-2694	11.00	31-6414-5	2.50
30-4609	*61-0122	31-2439	4.00	31-2694-1	*31-2694	31-6415	1.00
30-4610	*45-3500-7	31-2443	4.00	31-2700	2.75	31-6416	.75
30-4611	*61-0113	31-2446	4.00	31-2700-1	2.25	31-6417	3.25
30-4616	*45-3500-11	31-2447	7.00	31-2703	12.00	31-6418	.50
30-4621	*45-3500-6	31-2451	2.25	31-2703-2	12.00	31-6424	3.50
30-4622	*61-0062	31-2453	.40	31-2703-6	15.00	31-6426	.35
30-4623	*61-0179	31-2455	4.00	31-2705	6.25	31-6428	1.10
30-4624	*45-3500-3	31-2459	5.00	31-2705-1	5.00	31-6430	1.10
30-4630	*45-3500-7	31-2461	4.00	31-2707	4.50	31-6432	.70
30-4632	1.00	31-2465	.45	31-2708-2	4.50	31-6433	2.00
30-4641	.75	31-2466	4.35	31-2715	7.00	31-6435	1.40
30-4642	3.10	31-2467	2.00	31-2715-1	8.00	31-6436	.90
30-4644	.50	31-2472	4.00	31-2708	*31-2708-2	31-6437	.35
30-4644-1	.40	31-2474	4.00	31-2716	.50	31-6438	.50
30-4644-3	.60	31-2476	4.00	31-2718	.35	31-6439	2.00
30-4646	17.00	31-2483	5.00	31-2718-1	.30	31-6440	.50
30-4647	7.00	31-2484-2	1.35	31-2718-2	.30	31-6443	2.25
30-4650-47	†	31-2485	4.50	31-2718-3	3.00	31-6444	1.10
30-4650-52	†	31-2490	4.00	31-2718-4	.45	31-6447	*31-6451
30-4650-53	†	31-2491	*31-2490	31-2719	8.00	31-6449	2.75
30-4650-58	†	31-2492	4.00	31-2719-1	6.20	31-6449-1	5.50
30-4650-64	†	31-2493	4.00	31-2719-2	6.60	31-6450	1.35
30-4650-86	†	31-2498	.20	31-2721	5.50	31-6451	1.85
30-4650-92	†	31-2499	7.00	31-2721-1	7.75	31-6453	.90
30-4650-93	†	31-2500	5.00	31-2722	4.25	31-6464	1.50
30-4650-98	†	31-2507	6.00	31-2722-1	4.50	31-6472	.75
30-4651-3	.35	31-2509	4.00	31-2722-2	4.00	31-6473	.25
30-4661	.30	31-2515	4.50	31-2722-3	4.00	31-6473-2	.35
30-4661-2	1.50	31-2518	.70	31-2723	5.25	31-6473-3	.80
31-1056	.75	31-2522	4.00	31-2723-2	6.75	31-6473-4	.35
31-1057	1.50	31-2527	5.00	31-2724	12.50	31-6473-5	.35
31-1125	*31-1209	31-2527-1	5.00	31-2724-2	10.00	31-6473-6	.45
31-1186	.85	31-2527-2	5.50	31-2724-3	12.50	31-6473-7	.75
31-1191	*31-1209	31-2531	1.35	31-2724-6	14.00	31-6474	.35
31-1209	1.10	31-2533	4.00	31-2724-7	14.00	31-6476	1.10
31-1234	.45	31-2535	6.00	31-2725	9.25	31-6476-3	.80
31-1327	*28-8260	31-2539	*31-2658	31-2725-1	12.50	31-6476-4	.90
31-1363	1.10	31-2544	4.00	31-2725-2	9.25	31-6476-5	.85
31-1408	.45	31-2548	6.50	31-2726	8.00	31-6476-7	.90
31-1553	7.50	31-2549	4.00	31-2727	4.25	31-6476-8	1.10
31-1556	*31-1555	31-2554	.60	31-2727-1	4.00	31-6476-12	1.85
31-1563	2.00	31-2555	5.00	31-2727-2	4.00	31-6476-13	.70
31-1576	*31-1600	31-2556	4.00	31-2727-3	4.25	31-6476-16	.85

* Recommended substitute.

† Refer to distributor.

ALL PRICES SUBJECT TO CHANGE WITHOUT NOTICE

RADIO PARTS PRICE LIST—Continued

PART NUMBER	LIST PRICE or Substitute	PART NUMBER	LIST PRICE or Substitute	PART NUMBER	LIST PRICE or Substitute	PART NUMBER	LIST PRICE or Substitute
31-6476-17	.65	32-1637	*32-1869	32-2176	*45-6389	32-2602	*45-6365
31-6476-18	.70	32-1642	*45-6365	32-2183	*45-6389	32-2604	*45-6365
31-6476-19	1.00	32-1644	.15	32-2186	*45-6389	32-2615	*45-6364
31-6477	1.00	32-1646	*45-6365	32-2192	1.00	32-2616	*32-2146
31-6477-1	1.25	32-1647	*45-6365	32-2197	*45-6389	32-2617	*45-6389
31-6477-2	1.40	32-1669	2.00	32-2198	1.00	32-2621	*45-6364
31-6477-3	3.00	32-1671	*45-6365	32-2209	3.25	32-2625	*45-7502
31-6477-4	1.70	32-1672	*45-6365	32-2211	3.25	32-2627	*45-6389
31-6477-9	1.20	32-1673	*45-6365	32-2212	*45-6364	32-2628	*45-6389
31-6477-10	1.25	32-1699	*32-1867	32-2213	*45-6378	32-2629	*45-6364
31-6477-11	1.40	32-1708	5.50	32-2215	8.00	32-2630	*45-6364
31-6477-12	1.50	32-1710	5.00	32-2217	*32-2361	32-2631	*45-7502
31-6479	5.50	32-1711	*32-1876	32-2218	.75	32-2632	1.40
31-6479-1	4.00	32-1712	*32-1836	32-2219	1.50	32-2633	*45-6389
31-6480	2.00	32-1726	*45-6365	32-2221	.75	32-2635	*45-6365
31-6480-1	1.85	32-1734	*32-1865	32-2226	*32-2727	32-2643	*45-6365
31-6480-2	2.00	32-1735	5.50	32-2230	1.85	32-2644	*45-6365
31-6480-3	2.25	32-1736	5.50	32-2249	*32-2537	32-2645	*45-6365
31-6480-8	2.65	32-1751	5.50	32-2252	*45-6365	32-2660	2.20
31-6480-9	1.60	32-1752	4.50	32-2253	*32-2169	32-2664	*32-2841
31-6489	1.75	32-1793	*45-6365	32-2255	*32-2171	32-2666	*45-6365
31-6493	*31-6511-2	32-1809	*32-1836	32-2274	*45-6365	32-2667	*45-6364
31-6493-1	*31-6511-1	32-1810	*32-1836	32-2275	*45-6365	32-2668	*45-6389
31-6495-2	.90	32-1830	*45-6365	32-2276	*45-6365	32-2672	*45-6365
31-6497-4	6.75	32-1835	*32-1836	32-2277	*45-6365	32-2674	*45-6365
31-6501	10.00	32-1836	2.50	32-2286	*45-6365	32-2676	*45-6365
31 6504-1	1.00	32-1843	*45-6365	32-2288	*32-2727	32-2677	3.75
31-6504-2	.80	32-1844	*45-6365	32-2293	4.50	32-2703	*32-2841
31-6505	1.60	32-1864	*45-6365	32-2296	*45-6365	32-2705	*45-6365
31-6507	9.00	32-1865	2.50	32-2297	*45-6365	32-2718	*45-6364
31-6507-1	4.00	32-1866	*45-6365	32-2299	*45-6365	32-2727	3.50
31-6507-2	6.25	32-1867	7.00	32-2300	2.50	32-2728	*45-6365
31-6507-3	3.50	32-1868	7.25	32-2302	*45-6365	32-2741	*32-3089
31-6507-4	14.00	32-1869	4.50	32-2303	*32-2300	32-2742	10.00
31-6507-5	7.00	32-1917	*32-1836	32-2312	*45-6365	32-2763	3.25
31-6508	1.00	32-1929	*45-6365	32-2314	*45-6365	32-2765	2.75
31-6509	.50	32-1954	1.00	32-2327	*45-6365	32-2767	*45-6365
31-6510	3.25	32-1978	*32-1836	32-2333	*45-6365	32-2769	*32-2300
31-6511	.50	32-1984	1.35	32-2335	3.25	32-2772	*32-2727
31-6511-1	.70	32-1986	3.25	32-2350	*45-6364	32-2775	*45-6365
31-6511-2	.60	32-2003	2.25	32-2357	*32-2215	32-2790	*45-6365
31-6513	.50	32-2005	*45-6365	32-2361	5.50	32-2791	*45-6365
		32-2006	*45-6365	32-2362	4.50	32-2793	*45-6365
		32-2020	2.50	32-2375	*45-6389	32-2795	*45-6365
32-1049	*45-6365	32-2021	*45-6365	32-2376	*32-2362	32-2812	.40
32-1062	*32-1069	32-2026	*45-6365	32-2378	3.00	32-2821	1.15
32-1069	3.25	32-2027	*45-6365	32-2379	*45-6364	32-2823	1.75
32-1078	*32-1281	32-2030	2.25	32-2381	1.85	32-2828	3.00
32-1155	5.00	32-2041	*32-3182	32-2382	{ *1EA45-6389-2 *1EA45-6389-3	32-2830	1.40
32-1172	*32-1262	32-2046	*45-6389	32-2383	1.00	32-2841	3.00
32-1186	*45-6365	32-2047	*45-7502	32-2385	1.85	32-2849	*32-3089
32-1187	*45-6365	32-2050	*45-6365	32-2386	*45-6389	32-2850	*32-2742
32-1188	*45-6365	32-2059	*45-6365	32-2445	*45-6389	32-2852	*45-6365
32-1260	*32-1281	32-2100	*45-6365	32-2446	*45-6365	32-2889	*45-6389
32-1262	1.35	32-2101	*45-6365	32-2449	*45-6364	32-2900	*45-6365
32-1271	*45-6365	32-2102	*45-6365	32-2457	*45-6365	32-2908	*45-6365
32-1281	.60	32-2103	*45-6365	32-2461	*45-6364	32-2917	*45-6365
32-1288	*45-6365	32-2105	*45-6364	32-2477	.15	32-2918	*45-6365
32-1289	*45-6365	32-2120	*45-7502	32-2534	*45-6365	32-2925	.80
32-1304	*45-6365	32-2126	*45-6389	32-2536	*45-6365	32-2929	*45-6365
32-1305	*45-6365	32-2128	*45-6364	32-2537	.45	32-2944	*45-6365
32-1310	*45-6364	32-2139	4.00	32-2557	4.50	32-2945	*45-6364
32-1311	.70	32-2142	*45-6389	32-2558	1.00	32-2947	1.00
32-1313	*32-1155	32-2143	*45-6389	32-2559	*45-7502	32-2986	*45-6364
32-1315	*45-6365	32-2144	*32-2030	32-2560	*45-6389	32-2994	*45-6365
32-1329	*45-6365	32-2146	1.85	32-2573	*45-6389	32-2995	*45-6365
32-1360	1.85	32-2147	{ *1EA45-6389-2 *1EA45-6389-3	32-2575	*45-6364	32-2996	*45-6365
32-1362	*45-6365	32-2149	*45-6389-2	32-2576	1.00	32-3013	*45-6365
32-1374	2.50	32-2151	{ *1EA45-6389-1 *1EA45-6389-2	32-2580	*45-6365	32-3014	*45-6365
32-1374-2	.20	32-2159	*45-6364	32-2582	*45-6365	32-3015	*45-6365
32-1374-3	.20	32-2160	*45-6365	32-2583	*45-6364	32-3018	*45-6365
32-1378	*32-1360	32-2163	*45-6365	32-2584	*45-6365	32-3019	*45-7502
32-1448	*45-6365	32-2164	*45-6365	32-2586	*45-7502	32-3025	1.00
32-1470	2.50	32-2167	*45-6365	32-2592	2.25	32-3026	5.00
32-1471	*45-6365	32-2169	6.00	32-2596	1.40	32-3027	6.00
32-1477	*32-1155	32-2170	*32-2169	32-2597	1.75	32-3028	6.00
32-1481	*32-1360	32-2171	7.00	32-2598	1.00	32-3029	*45-6365
32-1538	*45-6365	32-2175	1.85	32-2599	*45-6365	32-3030	*45-6365
32-1618	1.85			32-2600	*45-6365	32-3037	1.25
32-1621	*45-6365					32-3040	*45-7502
32-1636	*32-1868						

* Recommended substitute.

ALL PRICES SUBJECT TO CHANGE WITHOUT NOTICE

RADIO PARTS PRICE LIST—Continued

PART NUMBER	LIST PRICE or Substitute	PART NUMBER	LIST PRICE or Substitute	PART NUMBER	LIST PRICE or Substitute	PART NUMBER	LIST PRICE or Substitute
32-3041	.65	32-3218	1.35	32-3404	1.50	32-3509	*45-6365
32-3042	1.10	32-3219	1.50	32-3407	*45-6365	32-3510	*45-6365
32-3046	1.35	32-3220	*45-6389	32-3415	.60	32-3515	*45-6389-2
32-3052	*45-6389-2	32-3222	*45-6365	32-3416	.50	32-3516	*45-6389-2
32-3053	1.35	32-3223	2.50	32-3417	*45-6364	32-3517	.50
32-3054	1.75	32-3226	*45-7502	32-3418	*45-6389	32-3517-1	.45
32-3055	{ *IEA45-6389-2	32-3227	*45-6364	32-3419	*45-6389	32-3518	.80
	{ *IEA45-6389-3	32-3230	1.60	32-3420	*45-6389	32-3520	.50
32-3056	*45-6378	32-3231	1.00	32-3421	.90	32-3522	.40
32-3075	*45-6365	32-3233	2.00	32-3422	1.50	32-3523	.35
32-3076	*45-6365	32-3234	*45-6389	32-3423	*45-7502	32-3524	2.50
32-3078	8.00	32-3236	*45-6389	32-3424	2.00	32-3525	2.50
32-3079	*45-6365	32-3237	*45-6365	32-3425	*45-7502	32-3526	*32-3401
32-3080	*45-6364	32-3238	*45-6365	32-3426	1.50	32-3527	4.50
32-3081	*45-6365	32-3240	*45-7502	32-3429	*45-6365	32-3530	1.85
32-3083	1.35	32-3243	*45-6365	32-3430	*45-6365	32-3531	1.85
32-3084	*45-6364	32-3244	*45-7502	32-3431	.60	32-3534	*45-6365
32-3085	*45-6389	32-3245	6.00	32-3432	*45-6389	32-3536	1.85
32-3086	*45-6365	32-3246	*45-6365	32-3435	1.10	32-3537	*45-6365
32-3087	*45-6365	32-3250	*45-6365	32-3441	*45-6389	32-3538	*45-6365
32-3088	*45-6365	32-3252	*45-7502	32-3442	*45-6365	32-3539	1.10
32-3089	5.00	32-3254	*45-7502	32-3443	*32-3992	32-3540	*45-6365
32-3092	*45-6387	32-3255	2.50	32-3444	*45-6365	32-3543	*45-6364
32-3094	*45-6389-2	32-3256	3.50	32-3445	*45-6365	32-3544	1.10
32-3099	{ *IEA45-6389-2	32-3265	2.50	32-3447	*45-6364	32-3545	1.35
	{ *IEA45-6389-3	32-3266	*45-6365	32-3448	*45-7502	32-3546	1.00
32-3103	*45-6365	32-3273	1.50	32-3449	*45-6389-2	32-3547	*45-6389
32-3105	*45-6389-2	32-3274	*32-3424	32-3450	*45-6389-2	32-3548	.50
32-3106	{ *IEA45-6389-2	32-3275	3.25	32-3451	*45-6389	32-3549	*45-6365
	{ *IEA45-6389-3	32-3276	.60	32-3452	*45-6389	32-3550	*45-6365
32-3107	*45-6389-2	32-3278	1.25	32-3453	*45-6389	32-3551	.90
32-3108	*45-6389	32-3281	*45-6365	32-3454	*45-6389	32-3557	1.85
32-3109	*45-6389	32-3282	1.50	32-3455	*45-6389	32-3558	*45-6389-2
32-3112	*45-6389	32-3284	4.50	32-3456	*45-6389	32-3559	*32-3615
32-3113	*45-6389	32-3285	*45-6365	32-3457	*45-6389	32-3560	*45-6365
32-3114	*32-3284	32-3286	*45-6365	32-3458	*45-6364	32-3561	*45-6365
32-3117	*45-6365	32-3287	1.10	32-3459	.75	32-3562	*32-4095-2
32-3120	*45-6365	32-3288	1.50	32-3460	.60	32-3566	*45-6365
32-3121	*45-6365	32-3289	1.50	32-3461	*45-6364	32-3569	*45-6364
32-3127	*45-6365	32-3290	*45-7502	32-3462	.60	32-3571	*45-6364
32-3129	*45-6365	32-3291	*45-7502	32-3463	*45-6389-2	32-3572	.70
32-3133	*45-6365	32-3292	*45-7502	32-3464	.75	32-3573	*45-6365
32-3134	*45-6365	32-3293	.60	32-3465	*45-6365	32-3577	*45-6389
32-3137	1.10	32-3294	*45-6389-2	32-3466	*45-6365	32-3578	1.35
32-3138	*45-6365	32-3296	2.00	32-3467	*45-6365	32-3579	2.00
32-3139	*45-6365	32-3297	*45-6365	32-3468	*45-6364	32-3580	.75
32-3140	*45-6365	32-3299	*45-6369	32-3469	1.10	32-3581	.90
32-3149	2.00	32-3303	*45-6364	32-3470	1.10	32-3583	3.00
32-3150	*32-3426	32-3304	*45-6365	32-3471	.90	32-3584	3.00
32-3151	*32-3166	32-3321	*45-6364	32-3472	*45-6365	32-3586	1.25
32-3152	*32-3167	32-3327	*45-6365	32-3473	*45-6365	32-3588	2.25
32-3161	*45-6364	32-3328	*45-6365	32-3475	*45-6364	32-3590	.90
32-3162	*45-6389	32-3347	*45-6365	32-3476	.75	32-3593	*45-6365
32-3164	1.75	32-3350	*45-6365	32-3478	4.00	32-3594	*45-6365
32-3166	1.60	32-3352	.60	32-3479	2.25	32-3595	.75
32-3167	*45-7502	32-3365	*45-6365	32-3481	.60	32-3597	.50
32-3169	*45-6364	32-3366	*65-0192	32-3482	*45-6365	32-3601	1.50
32-3176	*45-6365	32-3367	.50	32-3483	*45-6365	32-3602	1.85
32-3177	*45-6365	32-3372	.35	32-3484	*45-6365	32-3603	*45-6365
32-3178	*65-0192	32-3373	*45-7502	32-3485	2.25	32-3604	*45-6365
32-3180	*45-6365	32-3374	*45-6389	32-3487	*45-6364	32-3613	*45-7502
32-3181	*32-3963	32-3376	1.35	32-3489	*45-6365	32-3614	*45-6365
32-3182	4.00	32-3377	.80	32-3490	1.70	32-3615	.75
32-3183	*32-3490	32-3378	.60	32-3491	.75	32-3616	*45-6365
32-3184	.80	32-3379	*45-6365	32-3492	*45-6365	32-3617	*45-6365
32-3185	*65-0399	32-3380	*65-0192	32-3493	*45-6365	32-3618	*45-6365
32-3188	*45-6365	32-3381	*45-6389	32-3494	2.25	32-3619	1.50
32-3189	*45-6364	32-3382	*45-6365	32-3495	*45-6365	32-3620	*45-6365
32-3191	.70	32-3383	*45-6365	32-3496	1.85	32-3621	*45-6365
32-3194	*32-3372	32-3384	*32-3265	32-3497	.75	32-3622	*45-6364
32-3195	4.25	32-3385	*32-3424	32-3498	*45-6389-2	32-3623	*45-6365
32-3196	*45-6389	32-3385-2	.60	32-3499	1.85	32-3625	*45-6365
32-3197	*45-6389	32-3385-3	.75	32-3500	*45-6389	32-3626	2.00
32-3198	*45-6365	32-3385-4	1.00	32-3501	*45-6365	32-3627	*45-6389-2
32-3190	*32-3903	32-3390	*45-6365	32-3503	*45-6365	32-3628	2.25
32-3210	2.50	32-3391	6.25	32-3504	1.10	32-3629	*45-6365
32-3211	*45-6365	32-3394	1.10	32-3505	1.85	32-3631	*45-6365
32-3212	2.50	32-3398	*45-6365	32-3506	1.25	32-3632	.60
32-3213	*32-3195	32-3399	*45-6365	32-3507	2.50	32-3633	*32-3685
32-3217	*45-7502	32-3401	.60	32-3508	*45-6365	32-3634	.75

* Recommended substitute.

ALL PRICES SUBJECT TO CHANGE WITHOUT NOTICE

RADIO PARTS PRICE LIST—Continued

PART NUMBER	LIST PRICE or Substitute	PART NUMBER	LIST PRICE or Substitute	PART NUMBER	LIST PRICE or Substitute	PART NUMBER	LIST PRICE or Substitute
32-3635	1.10	32-3728	1.50	32-3815	*45-6364	32-3950	*32-3963
32-3636	.60	32-3729	*45-6389-2	32-3818	1.10	32-3951	*32-3949
32-3637	.40	32-3730	.90	32-3820	5.50	32-3952	2.50
32-3638	*45-6365	32-3731	3.25	32-3821	*32-3836	32-3955	*32-3958
32-3639	*45-6365	32-3732	1.00	32-3822	5.50	32-3955-2	2.75
32-3641	.80	32-3733	*45-6365	32-3823	*45-6364	32-3955-3	2.75
32-3642	2.50	32-3734	*45-6365	32-3824	*45-6389-2	32-3956	*45-6365
32-3643	4.50	32-3735	*45-6389	32-3825	2.25	32-3956-1	*45-6365
32-3644	*45-6364	32-3736	*45-6365	32-3826	*32-3809	32-3956-2	3.00
32-3646	1.85	32-3737	*45-6365	32-3827	1.85	32-3956-3	3.00
32-3647	*45-6364	32-3739	*45-6364	32-3828	*32-3820	32-3957	2.50
32-3648	*45-6365	32-3740	1.25	32-3829	5.50	32-3957-2	3.25
32-3649	1.50	32-3741	1.00	32-3830	3.25	32-3957-3	2.50
32-3651	2.00	32-3742	*45-6365	32-3831	*45-6389	32-3958	2.50
32-3652	1.00	32-3743	*45-6365	32-3834	1.85	32-3959	*45-6365
32-3653	*45-6365	32-3744	*45-6365	32-3836	3.25	32-3960	*32-3957
32-3654	*45-6365	32-3746	*45-6364	32-3838	.50	32-3961	*32-3958
32-3655	1.25	32-3747	1.25	32-3839	1.35	32-3962	2.40
32-3656	.85	32-3748	.90	32-3843	*32-3820	32-3962-2	2.50
32-3657	*45-6365	32-3749	.90	32-3844	*32-3836	32-3962-3	3.00
32-3658	.90	32-3750	*45-6364	32-3845	*32-3829	32-3963	2.25
32-3659	†	32-3751	.35	32-3846	*45-6364	32-3964	*32-3963
32-3660	*45-6365	32-3752	.75	32-3846-1	2.50	32-3965	*32-3962
32-3661	2.00	32-3753	1.00	32-3848	*45-6365	32-3966	2.25
32-3662	.60	32-3754	.50	32-3849	*45-6364	32-3967	2.50
32-3663	.70	32-3755	*45-6364	32-3850	*45-6365	32-3968	2.00
32-3664	.70	32-3756	1.25	32-3851	*45-6365	32-3968-3	1.85
32-3665	.70	32-3757	*45-6389-2	32-3852	*45-6364	32-3968-4	*45-6365
32-3667	.60	32-3758	*45-6365	32-3854	.35	32-3969	*45-6365
32-3668	.60	32-3759	*32-3731	32-3856	1.50	32-3970	2.75
32-3669	.75	32-3760	*45-6389	32-3857	*45-6364	32-3971	3.50
32-3670	.80	32-3761	*45-6389	32-3858	.30	32-3971-2	3.50
32-3671	.80	32-3762	1.25	32-3859	*45-6365	32-3972	2.50
32-3672	*45-6389	32-3763	*45-6364	32-3860	*45-6365	32-3973	*32-4095-1
32-3673	1.40	32-3764	.35	32-3861	.60	32-3974	2.75
32-3674	*45-6365	32-3765	.50	32-3863	2.50	32-3974-2	2.85
32-3675	*45-6365	32-3766	*45-6389-2	32-3864	*45-6364	32-3976	2.50
32-3676	*45-6389	32-3768	*45-6389-2	32-3865	2.25	32-3977	*65-0319
32-3677	*45-6364	32-3770	.50	32-3866	1.50	32-3978	2.75
32-3678	*45-6364	32-3771	.80	32-3869	2.25	32-3979	*45-6365
32-3679	*45-6389-2	32-3772	*45-6364	32-3870	2.75	32-3980	4.25
32-3680	*45-6389-2	32-3773	*45-6365	32-3871	3.00	32-3981	5.00
32-3681	*45-6389	32-3774	*45-6365	32-3877	*45-6364	32-3982	6.25
32-3682	*45-6389	32-3775	*45-6365	32-3879	1.10	32-3982-1	6.75
32-3683	*45-6389	32-3776	1.75	32-3880	*45-7502	32-3983	4.25
32-3684	*45-6389	32-3777	*45-6365	32-3881	2.25	32-3986	*32-3265
32-3685	.90	32-3779	1.50	32-3882	2.00	32-3987	*32-3987-3
32-3687	1.85	32-3780	.50	32-3885	3.45	32-3887-1	*45-6365
32-3688	*45-6365	32-3781	*45-6365	32-3895-1	3.25	32-3887-2	*32-3987-3
32-3690	*45-6389-2	32-3782	1.85	32-3895-2	4.00	32-3887-3	2.85
32-3692	*45-6389	32-3784	*45-6364	32-3897	3.25	32-3991	2.50
32-3693	*45-6389-2	32-3785	*32-3866	32-3897-2	3.25	32-3992	.20
32-3694	*45-6389-2	32-3786	.50	32-3898	*45-6365	32-3993	.20
32-3695	*45-6389	32-3787	5.50	32-3899	*45-6365	32-3994	.20
32-3696	*45-6365	32-3788	*32-3836	32-3901	2.50	32-3995	*32-3952
32-3697	*45-6364	32-3789	10.00	32-3902	4.00	32-3996	.60
32-3698	.75	32-3790	*45-6364	32-3903	2.00	32-3996-1	.60
32-3704	*45-6365	32-3791	1.10	32-3904	5.25	32-3996-2	*32-4113
32-3705	*45-6365	32-3792	2.25	32-3906	*32-3963	32-4001	5.50
32-3706	*45-6365	32-3793	.90	32-3908-1	3.75	32-4002	4.00
32-3708	*45-6364	32-3794	5.50	32-3908-2	4.50	32-4003	*32-4002
32-3710	*45-6365	32-3795	*32-3788	32-3909	*32-3907	32-4003-1	5.10
32-3711	*45-6365	32-3796	*32-3789	32-3919	2.25	32-4003-2	5.30
32-3712	*45-6365	32-3797	2.25	32-3919-1	*32-3920	32-4004	7.50
32-3713	*45-6365	32-3798	1.70	32-3919-2	2.40	32-4005	*AD-1024
32-3714	*45-6364	32-3799	*45-6365	32-3919-3	2.40	32-4007	.65
32-3715	1.00	32-3800	*45-6365	32-3919-4	2.25	32-4007-1	.30
32-3715-1	2.25	32-3801	*32-3820	32-3920	1.50	32-4007-2	.80
32-3716	.35	32-3802	4.50	32-3935	*45-6365	32-4008	*45-6364
32-3717	*45-6364	32-3803	*32-3829	32-3944	*32-3963	32-4009	2.75
32-3718	.45	32-3804	1.35	32-3948	2.80	32-4010	1.15
32-3719	.75	32-3805	2.50	32-3948-5	2.75	32-4011	2.00
32-3720	1.60	32-3806	1.25	32-3948-7	2.75	32-4014	3.00
32-3721	*45-6365	32-3807	*45-6364	32-3948-9	3.25	32-4015	*32-3949
32-3722	*45-6365	32-3808	1.00	32-3948-10	2.75	32-4016	.30
32-3723	1.25	32-3809	1.00	32-3948-11	*32-3948-13	32-4017	.30
32-3724	*45-6364	32-3811	*45-6364	32-3948-13	3.25	32-4018	.35
32-3725	.35	32-3812	*45-6389	32-3948-14	6.00	32-4018-2	.25
32-3726	*45-6364	32-3813	*45-6365	32-3949	2.40	32-4018-4	.30
32-3727	1.85	32-3814	*45-6365	32-3949-1	3.00	32-4018-5	.35

* Recommended substitute.
† Refer to distributor.

ALL PRICES SUBJECT TO CHANGE WITHOUT NOTICE

RADIO PARTS PRICE LIST—Continued

PART NUMBER	LIST PRICE or Substitute	PART NUMBER	LIST PRICE or Substitute	PART NUMBER	LIST PRICE or Substitute	PART NUMBER	LIST PRICE or Substitute
32-4018-6	.45	32-4072	11.25	32-4146-2	6.00	32-4211	1.50
32-4018-7	.45	32-4074	7.00	32-4147	6.75	32-4212	1.25
32-4018-8	*32-4159-1	32-4079	6.00	32-4147-1	7.00	32-4212-1	1.50
32-4019	.90	32-4080	.30	32-4151	1.75	32-4212-2	1.15
32-4019-1	1.00	32-4081	1.80	32-4151-1	3.00	32-4213	6.00
32-4019-2	.90	32-4082	1.50	32-4152	2.25	32-4213-1	4.50
32-4019-3	*32-4019-2	32-4083	1.50	32-4152-1	3.25	32-4214	*32-4214-3
32-4019-4	1.25	32-4084	1.80	32-4153	.75	32-4214-1	*32-4214-3
32-4019-5	1.50	32-4085	1.75	32-4153-1	1.00	32-4214-2	*32-4214-3
32-4019-6	1.25	32-4086	1.25	32-4155	1.20	32-4214-3	4.00
32-4019-7	1.50	32-4087	.70	32-4156	4.85	32-4214-4	*32-4214-3
32-4020	4.50	32-4087-1	.65	32-4156-2	6.00	32-4216	1.25
32-4020-1	*32-4020	32-4088	1.25	32-4157	.25	32-4216-1	1.00
32-4022	4.50	32-4089	.20	32-4157-1	.35	32-4216-2	1.25
32-4023-1	3.00	32-4089-2	.25	32-4157-2	.30	32-4216-3	1.50
32-4026	2.25	32-4092	1.40	32-4158	.20	32-4216-4	1.25
32-4032	6.00	32-4093	3.25	32-4158-1	.25	32-4217	2.40
32-4033	3.00	32-4093-1	2.60	32-4159	.50	32-4217-1	2.00
32-4033-1	3.00	32-4093-3	2.50	32-4159-1	.25	32-4218	1.00
32-4033-2	3.00	32-4094	*32-4213	32-4160A	2.00	32-4221	.85
32-4033-4	3.25	32-4094-1	*32-4213-1	32-4160-1	3.00	32-4221-1	1.00
32-4033-7	2.60	32-4095	*45-7502	32-4160-2A	2.00	32-4221-2	1.00
32-4033-9	2.50	32-4095-1	1.25	32-4160-3A	2.15	32-4221-3	1.00
32-4033-10	2.50	32-4095-2	.80	32-4160-4A	1.90	32-4222-2	3.00
32-4033-11	2.50	32-4095-3	1.25	32-4160-6A	2.25	32-4222-3	3.00
32-4043	1.80	32-4095-5	.85	32-4161A	2.00	32-4222-4	3.00
32-4044	.75	32-4099	1.75	32-4161-1	2.75	32-4222-5	3.00
32-4049	2.25	32-4100	2.00	32-4161-2A	2.00	32-4222-6	3.00
32-4049-1	2.50	32-4101	*32-4214-3	32-4162	2.00	32-4222-7	3.00
32-4049-3	2.25	32-4101-1	*32-4214-3	32-4163	*45-9527	32-4222-8	3.00
32-4050	.45	32-4102	.50	32-4163-1	*45-9527	32-4222-9	3.00
32-4050-2	.45	32-4104	.50	32-4163-2	*45-9527	32-4222-10	3.00
32-4050-3	.35	32-4106	3.75	32-4170	.50	32-4222-11	3.00
32-4050-4	.45	32-4107	*45-6365	32-4178	1.25	32-4222-12	3.00
32-4050-5	.45	32-4108	4.00	32-4179	.50	32-4222-13	3.00
32-4050-6	.45	32-4110	1.30	32-4179-1	.50	32-4233	*32-4233-2
32-4050-10	.45	32-4110-2	1.40	32-4179-2	.50	32-4234-1	.75
32-4052-2	*32-4052-16	32-4111	.12	32-4179-3	.50	32-4234-3	1.00
32-4052-3	.25	32-4112-2	.50	32-4179-4	.50	32-4234-4	1.00
32-4052-4	.40	32-4112-3	*32-4112-11	32-4180	.30	32-4235	1.25
32-4052-5	.50	32-4112-4	.40	32-4180-1	.30	32-4238	2.25
32-4052-6	.40	32-4112-11	.35	32-4180-2	.30	32-4240A	2.00
32-4052-7	.60	32-4112-15	.40	32-4180-3	.30	32-4240-2A	2.40
32-4052-9	.45	32-4113	1.00	32-4180-4	.30	32-4240-3	*32-4240-3A
32-4052-10	.60	32-4115-2	4.00	32-4184	.35	32-4240-3A	2.20
32-4052-11	.50	32-4115-3	4.00	32-4187	3.50	32-4242	1.70
32-4052-13	.60	32-4115-4	4.00	32-4188	1.50	32-4246	2.10
32-4052-14	.75	32-4115-5	4.00	32-4189	.70	32-4256	*32-4284
32-4052-15	.90	32-4115-6	4.00	32-4190	1.65	32-4257	*32-4257A
32-4052-16	1.00	32-4115-7	4.00	32-4190-1	1.10	32-4257A	2.75
32-4052-17	.60	32-4115-8	4.00	32-4190-2	1.00	32-4257-1A	*32-4257-1A
32-4052-18	1.00	32-4115-9	4.00	32-4191	2.75	32-4257-1A	2.50
32-4052-19	.65	32-4115-10	4.00	32-4192	1.65	32-4258	*32-4258A
32-4052-20	*76-2127-8	32-4115-11	4.00	32-4192-1	1.65	32-4258A	3.00
32-4052-21	.60	32-4115-12	4.00	32-4194	1.50	32-4260	.50
32-4052-22	.35	32-4115-13	4.00	32-4195	1.25	32-4261	*32-4161-1
32-4052-24	.65	32-4128-2	*32-4222-2	32-4196	2.25	32-4261-1	5.00
32-4052-25	.90	32-4128-3	*32-4222-3	32-4197	3.00	32-4263	.90
32-4052-27	.35	32-4128-4	*32-4222-4	32-4203	5.25	32-4266	3.00
32-4052-28	.50	32-4128-5	*32-4222-5	32-4204	3.75	32-4267	1.00
32-4052-29	*32-4347	32-4128-6	*32-4222-6	32-4204-1	1.50	32-4268	1.00
32-4054	.50	32-4128-7	*32-4222-7	32-4205	2.10	32-4269	1.00
32-4055	.50	32-4128-8	*32-4222-8	32-4206	1.00	32-4270	1.75
32-4056	.50	32-4128-9	*32-4222-9	32-4206-1	1.00	32-4273	.70
32-4057	.45	32-4128-10	*32-4222-10	32-4206-2	1.25	32-4273-1	.40
32-4059	2.25	32-4128-11	*32-4222-11	32-4206-3	1.00	32-4273-2	.50
32-4059-1	2.25	32-4128-12	*32-4222-12	32-4206-4	1.20	32-4274	.50
32-4059-2	1.80	32-4128-13	*32-4222-13	32-4206-5	1.00	32-4276	1.20
32-4059-4	.85	32-4141	*32-4064	32-4207	1.25	32-4280	1.35
32-4059-5	.90	32-4143	.60	32-4207-1	1.25	32-4282	1.25
32-4060	7.50	32-4143-1	.35	32-4207-2	1.80	32-4282-1	1.40
32-4061	.60	32-4143-2	.50	32-4208	2.00	32-4284	3.00
32-4061-1	*32-4111	32-4143-3	.50	32-4208-1	1.25	32-4284-1	3.75
32-4061-2	.25	32-4143-3	.50	32-4208-2	2.00	32-4285	2.75
32-4064	2.75	32-4143-4	.35	32-4208-3	2.00	32-4286	1.25
32-4065	*32-4235	32-4143-5	.70	32-4208-4	2.00	32-4287	3.00
32-4067	.20	32-4143-7	.65	32-4208-5	1.60	32-4288	3.00
32-4069	.90	32-4143-8	.50	32-4208-6	1.50	32-4295	1.25
32-4070	1.85	32-4146	5.65	32-4208-7	2.00	32-4297	2.40
32-4071	.25	32-4146-1	6.00	32-4210	3.00	32-4298	2.75

* Recommended substitute.

ALL PRICES SUBJECT TO CHANGE WITHOUT NOTICE

RADIO PARTS PRICE LIST—Continued

PART NUMBER	LIST PRICE or Substitute	PART NUMBER	LIST PRICE or Substitute	PART NUMBER	LIST PRICE or Substitute	PART NUMBER	LIST PRICE or Substitute
32-4299	2.75	32-7355	*32-7078	32-7849	*32-7828	32-8073	2.50
32-4300	3.25	32-7356	*32-7865	32-7853	*32-7640	32-8074	*32-8195
32-4301	.25	32-7372	*32-7471	32-7862	*32-7065	32-8075	9.00
32-4302	.90	32-7381	8.25	32-7864	*32-7905	32-8076	5.50
32-4303	1.10	32-7382	*32-8214	32-7865	6.00	32-8080	*32-8214
32-4306	*32-4217-1	32-7402	*32-7283	32-7866	*32-7078	32-8086	*32-8195
32-4310	3.75	32-7431	15.00	32-7867	*32-8076	32-8093	5.00
32-4311	2.25	32-7446	*32-7461	32-7868	2.25	32-8100	2.50
32-4315	.60	32-7452	*32-7668	32-7869	10.50	32-8106	2.50
32-4317	5.75	32-7453	*32-7286	32-7870	12.50	32-8107	*32-8152
32-4317-1	6.00	32-7461	5.50	32-7876	7.50	32-8108	4.50
32-4318	3.25	32-7471	6.00	32-7885	8.50	32-8109	6.00
32-4325	.70	32-7472	*32-7286	32-7886	11.75	32-8110	2.90
32-4326	1.00	32-7476	*32-7528	32-7889	11.75	32-8111	*32-7997
32-4329	2.50	32-7480	*32-7865	32-7905	4.50	32-8112	4.00
32-4330	4.00	32-7482	2.50	32-7908	*32-7829	32-8113	3.25
32-4336	1.25	32-7484	4.35	32-7909	*32-7829	32-8116	2.25
32-4337	1.25	32-7488	*32-7352	32-7910	1.60	32-8118	11.00
32-4338	2.00	32-7489	*32-7036	32-7911	*65-0046	32-8120	*32-8133
32-4339	1.00	32-7491	2.50	32-7925	6.00	32-8121	*32-8221
32-4340	1.25	32-7503	*32-7639	32-7928	3.75	32-8122	*32-8221
32-4341	1.50	32-7504	2.75	32-7934	6.50	32-8126	*32-8206
32-4342	2.10	32-7527	*32-7543	32-7943	*65-0035	32-8127	1.50
32-4343	1.40	32-7528	2.75	32-7944	*32-7821	32-8128	2.90
32-4344	1.50	32-7543	2.50	32-7951	*32-7821	32-8132	*32-8166
32-4345	3.50	32-7544	*32-7491	32-7954	4.50	32-8133	2.25
32-4346	4.00	32-7545	*32-7868	32-7955	*32-8116	32-8135	*32-8148
32-4347	.55	32-7551	*32-7634	32-7956	3.00	32-8137	*32-8186
32-4349	*32-4349-A	32-7552	5.75	32-7957	*32-8116	32-8138	*32-7997
32-4359	1.75	32-7554	5.50	32-7958	*65-0095	32-8139	2.25
32-4364-1	1.50	32-7562	3.75	32-7959	1.75	32-8140	*32-8186
32-4367	2.50	32-7566	1.90	32-7960	*32-8182	32-8142	7.25
32-4368	2.50	32-7567	2.50	32-7961	2.00	32-8144	1.75
32-4369	1.50	32-7568	*32-7566	32-7975	7.25	32-8147	*32-8195
32-4370	1.50	32-7569	1.85	32-7977	*32-8166	32-8148	5.50
32-4373	1.40	32-7572	*32-7668	32-7978	2.50	32-8149	*32-7975
32-4376	3.50	32-7583	10.25	32-7979	4.75	32-8150	*32-8195
32-7018	*32-7528	32-7597	*32-7837	32-7980	*32-8116	32-8151	*32-8214
32-7019	*32-7567	32-7606	*32-7640	32-7981	*32-7997	32-8152	1.85
32-7020	*32-7566	32-7615	*32-7699	32-7984	*32-8066	32-8155	2.50
32-7026	*32-7543	32-7627	*32-8214	32-7988	2.50	32-8156	5.00
32-7036	2.00	32-7634	3.75	32-7990	4.00	32-8157	6.50
32-7038	*32-7543	32-7638	*32-7078	32-7993	2.25	32-8162	*32-8296-5
32-7039	*32-7634	32-7639	3.75	32-7995	2.90	32-8163	3.50
32-7041	*32-7567	32-7640	13.00	32-7996	*32-7997	32-8164	*32-8173
32-7042	*32-7065	32-7662	*32-8184	32-7997	4.25	32-8165	3.50
32-7052	*32-7078	32-7663	*32-8242	32-8000	1.60	32-8166	8.00
32-7056	2.20	32-7667	*32-7528	32-8001	*32-7283	32-8167	3.25
32-7057	7.00	32-7671	7.00	32-8005	3.75	32-8168	*32-8252
32-7064	*32-7552	32-7681	*32-7865	32-8006	6.60	32-8170	3.00
32-7065	3.50	32-7682	6.50	32-8007	12.00	32-8172	2.00
32-7078	3.50	32-7684	*32-7078	32-8008	14.50	32-8173	1.65
32-7080	8.00	32-7685	*32-7078	32-8009	1.40	32-8175	1.75
32-7104	*32-7543	32-7688	17.00	32-8014	*32-7975	32-8176	*32-8206
32-7110	2.70	32-7699	15.50	32-8015	2.75	32-8178	*32-8109
32-7111	11.00	32-7700	12.00	32-8018	*32-7978	32-8180	*32-8206
32-7114	3.00	32-7710	*32-7543	32-8019	*32-8250	32-8182	2.00
32-7118	*32-7543	32-7717	*32-7078	32-8020	*32-7997	32-8183	5.00
32-7137	*32-7381	32-7720	*65-0095	32-8027	3.20	32-8184	3.75
32-7180	8.50	32-7721	*32-7562	32-8028	3.75	32-8186	18.00
32-7205	*32-7078	32-7722	*32-7491	32-8029	*32-7491	32-8187	*32-8221
32-7206	*32-7865	32-7724	*32-7829	32-8030	*32-7975	32-8189	1.65
32-7211	*32-7484	32-7727	*32-7078	32-8031	13.50	32-8190	2.50
32-7213	3.00	32-7751	*32-7078	32-8033	2.25	32-8191	*32-7997
32-7214	*32-7567	32-7753	*32-7461	32-8043	4.50	32-8192	*32-8223
32-7215	*32-7036	32-7754	*32-7634	32-8046	1.85	32-8195	9.25
32-7216	2.60	32-7758	*32-7639	32-8051	3.25	32-8196	4.25
32-7218	4.95	32-7764	1.25	32-8052	*32-8221	32-8197	*32-7997
32-7223	*32-7286	32-7778	*32-7829	32-8053	*32-8133	32-8201	1.25
32-7232	*32-7352	32-7779	*65-0097	32-8056	*32-8116	32-8202	*32-8252
32-7233	*32-7827	32-7780	*32-7552	32-8058	*32-7997	32-8203	1.25
32-7243	*32-7566	32-7786	*32-7634	32-8059	5.25	32-8204	*32-8226
32-7245	*32-7567	32-7788	*32-7639	32-8062	*32-8100	32-8205	*32-8031
32-7247	*32-7905	32-7811	*32-7491	32-8063	*32-8116	32-8206	2.25
32-7259	11.25	32-7821	6.75	32-8064	*32-8220	32-8207	*32-8206
32-7283	12.50	32-7822	2.50	32-8065	*32-8221	32-8208	1.50
32-7286	3.50	32-7826	6.50	32-8066	1.60	32-8210	8.50
32-7315	2.40	32-7828	5.50	32-8070	*32-7997	32-8211	*32-8271
32-7347	*32-7567	32-7829	2.50	32-8071	*32-7978	32-8214	14.00
32-7352	5.25	32-7837	12.25	32-8072	*32-8028	32-8215	3.00

* Recommended substitute.

ALL PRICES SUBJECT TO CHANGE WITHOUT NOTICE

RADIO PARTS PRICE LIST—Continued

PART NUMBER	LIST PRICE or Substitute	PART NUMBER	LIST PRICE or Substitute	PART NUMBER	LIST PRICE or Substitute	PART NUMBER	LIST PRICE or Substitute
32-8216	1.25	32-8316-1	2.35	33-1335-47	1.00	33-3269	.75
32-8219	*32-8144	32-8316-3	3.00	33-1335-74	1.00	33-3277	*33-3284
32-8220	7.00	32-8317	13.35	33-1335-75	1.25	33-3282	*33-3267
32-8221	7.50	32-8321	2.75	33-1335-79	1.60	33-3284	.35
32-8223	9.50	32-8321-1	2.75	33-1335-80	1.35	33-3289	.75
32-8226	8.25	32-8323	2.50	33-1335-83	2.30	33-3291	.60
32-8228	*32-8296-5	32-8324	3.25	33-1335-84	.40	33-3301	.90
32-8231	6.50	32-8325	3.00	33-1335-85	1.25	33-3302	*33-3311
32-8234	6.00	32-8327	12.00	33-1336	.75	33-3311	.90
32-8239	*32-8166	32-8328	10.75	33-1336-1	.75	33-3312	*33-3311
32-8240	*32-8100	32-8329	2.00	33-1336-2	.75	33-3316	*33-3284
32-8242	2.50	32-8330	2.50	33-1336-3	.75	33-3320	1.00
32-8242-3	*32-8242	32-8331	24.00	33-1336-4	.75	33-3334	1.00
32-8242-4	*32-8242	32-8344	40.00	33-1336-5	.75	33-3340-2	2.75
32-8243	8.75	32-8345-1	*32-8342	33-1336-7	.75	33-3350	3.30
32-8244-1	2.60	32-8350	11.00	33-1336-8	.75	33-3364	.65
32-8244-2	4.00	32-8351	2.90	33-1336-9	.75	33-3367	.85
32-8246	*32-8246-1	32-8354	*32-8354-1	33-1336-10	.75	33-3372	.40
32-8246-1	15.75	32-8354-1	17.00	33-1336-11	.75	33-3375	.85
32-8248	10.00	32-8355	*32-8355-1	33-1336-12	.75	33-3376	.45
32-8249	2.25	32-8355-1	2.90	33-1336-13	.75	33-3377	1.35
32-8250	2.25	32-8356	3.00	33-1336-14	.75	33-3387	*33-3400
32-8252	2.25	32-8356-1	2.25	33-1336-15	.75	33-3389	2.00
32-8255	*32-8116	32-8357	†	33-1336-16	.75	33-3391	2.25
32-8256	8.25	32-8357-2	*32-8376	33-1336-17	.75	33-3392	.50
32-8259	1.65	32-8358	22.50	33-1336-18	.75	33-3393	.60
32-8259-3	3.00	32-8363	3.65	33-1336-19	.85	33-3394	.50
32-8269	10.00	32-8363-1	4.75	33-1336-20	.85	33-3395	.50
32-8270	13.00	32-8364	*32-8364-1	33-1336-21	.90	33-3396	.50
32-8271	6.25	32-8364-1	40.00	33-1336-22	1.00	33-3400	.60
32-8274	2.75	32-8365	3.25	33-1336-23	1.00	33-3401	.35
32-8275	10.00	32-8366	9.25	33-1336-24	1.00	33-3406	*33-3425
32-8276	8.75	32-8367	*32-8367-1	33-1336-25	1.10	33-3407	.60
32-8276-1	7.00	32-8367-1	3.75	33-1336-51	.75	33-3408	.35
32-8276-2	3.30	32-8368	2.65	33-1338	4.10	33-3410	*33-3424
32-8278	1.40	32-8369	7.50	33-1339	1.00	33-3411	.45
32-8278-1	2.00	32-8376	28.00	33-1339-1	.45	33-3412	.35
32-8281	8.50	32-8378	15.00	33-1339-2	.60	33-3413	.70
32-8282	13.00	32-8379	4.25	33-1339-4	.60	33-3414	2.50
32-8284	8.75	32-8381	16.00	33-1339-5	.60	33-3415	.50
32-8285	8.45	32-8382	2.75	33-1339-9	.60	33-3416	.35
32-8286	15.00	32-8392	45.00	33-1339-11	.60	33-3417	.45
32-8287	2.95	32-9055	4.50	33-1339-12	.60	33-3418	.60
32-8289-2	2.60	32-9087	3.00	33-1343	.60	33-3420	.50
32-8296-2	*32-8310	32-9604	13.60	33-1343-1	.65	33-3423	2.25
32-8296-4	1.60	32-9608	*32-9613	33-1343-2	.45	33-3424	.95
32-8296-5	1.85	32-9610	5.75	33-3067	*33-3267	33-3425	.50
32-8297	2.05	32-9613	17.50	33-3137	*33-3226	33-3426	1.00
32-8300	4.75	32-9618	2.25	33-3201	*33-3259	33-3431	{ *1 ea33-1334 *1 ea33-3431-4
32-8300-1	7.00	32-9619	5.25	33-3202	*33-3242	33-3431-4	.75
32-8300-2	7.00	32-9621	9.00	33-3203	*33-1336-13	33-3431-5	1.15
32-8303	26.00			33-3211	.65	33-3432	.45
32-8304	3.50	33-1015	*45-1477	33-3212	.65	33-3433	.25
32-8304-3	3.50	33-1016	*45-1477	33-3226	.45	33-3434	.53
32-8304-4	3.00	33-1017	*33-1196	33-3235	.80	33-3435-1	.45
32-8305	*32-8331	33-1101	*45-1477	33-3242	.65	33-3435-2	.25
32-8306	6.40	33-1102	*33-1196	33-3243	.65	33-3435-3	.25
32-8306-1	7.00	33-1103	*33-1196	33-3244	.65	33-3435-4	2.25
32-8307	3.00	33-1113	.30	33-3245	.65	33-3435-5	2.50
32-8307-2	3.65	33-1192	*45-1477	33-3246	.65	33-3435-6	.45
32-8307-3	2.50	33-1193	*45-1477	33-3247	*33-1336-23	33-3435-7	1.10
32-8308	10.20	33-1195	*45-1477	33-3251	*33-1336	33-3435-11	.65
32-8309	*32-8392	33-1196	.50	33-3252	*33-1336-1	33-3435-14	.90
32-8309-1	*32-8392	33-1333	.35	33-3253	*33-1336-2	33-3435-15	.70
32-8310	1.95	33-1334	.20	33-3254	.65	33-3435-16	.90
32-8310-1	2.25	33-1334-1	.20	33-3255	.65	33-3435-17	1.00
32-8310-2	1.75	33-1334-3	.25	33-3256	*33-1336-5	33-3435-18	.90
32-8310-3	1.60	33-1334-4	.20	33-3257	*33-1336-7	33-3435-19	.85
32-8310-5	*32-8310-3	33-1334-5	.20	33-3258	.65	33-3435-20	.85
32-8311	*32-8364-1	33-1334-6	.60	33-3259	.75	33-3435-21	.75
32-8311-1	*32-8364-1	33-1334-7	.25	33-3260	.75	33-3436	.90
32-8312	3.00	33-1334-8	.30	33-3261	.75	33-3436-1	.90
32-8312-1	3.00	33-1334-10	.40	33-3262	*33-1336-13	33-3436-2	.90
32-8313	5.10	33-1335-16	1.00	33-3263	.75	33-3436-3	1.20
32-8314	4.25	33-1335-18	1.00	33-3264	.75	33-3440	1.60
32-8314-1	5.00	33-1335-19	.85	33-3265	*33-1336-25	33-3440-1	1.85
32-8314-2	*32-8314-1	33-1335-20	1.20	33-3266	.75	33-3440-2	3.00
32-8314-3	6.00	33-1335-22	1.25	33-3267	.75	33-3444	2.50
32-8315	2.20	33-1335-24	1.60	33-3268	.75	33-5000	*45-5011
32-8316	2.00	33-1335-25	1.85				

* Recommended substitute.
† Refer to distributor.

ALL PRICES SUBJECT TO CHANGE WITHOUT NOTICE

RADIO PARTS PRICE LIST—Continued

PART NUMBER	LIST PRICE or Substitute	PART NUMBER	LIST PRICE or Substitute	PART NUMBER	LIST PRICE or Substitute	PART NUMBER	LIST PRICE or Substitute
33-5001	*45-5010	33-5140	*45-5013	33-5287	1.50	33-5438	*45-5009
33-5002	*45-5010	33-5142	*45-5020	33-5288	2.25	33-5439	1.75
33-5003	*45-5001	33-5143	*33-5155	33-5289	*45-5007	33-5440	*45-5006
33-5004	*45-5013	33-5144	1.50	33-5290	*45-5018	33-5441	*45-5017
33-5005	*45-5003	33-5145	*33-5276	33-5291	2.25	33-5442	*45-5009
33-5006	*45-5013	33-5147	*45-2381	33-5295	1.50	33-5443	*45-5007
33-5007	*45-5013	33-5150	1.50	33-5298	*45-5009	33-5445	*33-5394
33-5008	*33-5021	33-5151	*33-5152	33-5299	*33-5439	33-5446	*45-5007
33-5009	*45-5027	33-5152	2.25	33-5300	2.25	33-5447	*45-5017
33-5010	*45-5013	33-5153	*45-5008	33-5301	*45-5018	33-5448	*45-5007
33-5011	*45-5010	33-5154	1.50	33-5303	*33-5394	33-5450	1.50
33-5014	*67-0019	33-5155	*33-5119	33-5304	*45-5009	33-5451	*45-5007
33-5016	2.50	33-5157	*33-5165	33-5305	*45-5007	33-5453	*45-5017
33-5017	*45-5010	33-5158	*33-5166	33-5306	*45-5007	33-5454	*45-5009
33-5019	*45-5010	33-5164	*38-7630	33-5310	*45-5017	33-5455	2.25
33-5020	*45-5020	33-5165	1.25	33-5312	*45-5017	33-5456	*45-5007
33-5021	2.00	33-5166	1.25	33-5314	1.75	33-5457	*45-5009
33-5022	*45-5008	33-5168	2.25	33-5319	*45-5007	33-5458	*45-5007
33-5023	2.10	33-5169	2.25	33-5320	*33-5323	33-5459	*45-5009
33-5024	*45-5011	33-5170	1.80	33-5321	*45-5018	33-5460	*33-5479
33-5025	*45-5013	33-5171	*45-5003	33-5323	1.50	33-5461	1.50
33-5026	2.10	33-5173	1.10	33-5324	*45-5008	33-5462	1.75
33-5027	*45-5009	33-5176	2.40	33-5325	1.50	33-5463	2.25
33-5028	*45-5008	33-5178	1.50	33-5326	2.25	33-5464	*45-5007
33-5029	*45-5007	33-5179	*38-8120	33-5329	2.25	33-5465	*45-5007
33-5030	*45-5006	33-5182	*45-5019	33-5331	*45-5017	33-5466	2.25
33-5044	*45-5006	33-5183	1.50	33-5332	*45-5007	33-5467	1.50
33-5051	*45-5504	33-5193	*45-5019	33-5333	1.85	33-5468	*45-5009
33-5055	*45-5003	33-5197	1.50	33-5334	*45-5009	33-5469	*45-5007
33-5056	2.50	33-5198	*45-5007	33-5335	*33-5439	33-5470	1.50
33-5057	*45-5010	33-5202	*33-5121	33-5336	*45-5007	33-5471	*33-5433
33-5059	*45-5011	33-5206	*45-5004	33-5375	*45-5017	33-5472	1.50
33-5060	2.00	33-5207	*38-8596	33-5389	*45-5017	33-5474	*45-5007
33-5063	*45-5013	33-5215	*45-5007	33-5390	*45-5017	33-5475	*45-5007
33-5064	*45-5020	33-5216	*45-5009	33-5391	*45-5007	33-5476	1.50
33-5065	*45-5013	33-5222	1.50	33-5392	*45-5009	33-5477	*45-5009
33-5066	*45-5011	33-5224	*45-5009	33-5393	2.25	33-5478	*45-5009
33-5067	2.25	33-5225	*33-5399	33-5394	2.25	33-5479	1.50
33-5068	*45-5011	33-5228	*33-5399	33-5395	*45-5009	33-5480	1.50
33-5069	*45-5011	33-5230	*45-5007	33-5396	*33-5462	33-5481	*45-5009
33-5070	*33-5103	33-5232	*45-5009	33-5397	*45-5007	33-5482	*45-5007
33-5071	2.25	33-5233	*45-5009	33-5398	*45-5017	33-5484	*45-5010
33-5072	*38-5851	33-5234	*45-5007	33-5399	1.25	33-5485	*45-5007
33-5073	*33-5280	33-5235	1.50	33-5400	1.45	33-5486	*45-5007
33-5079	*45-5003	33-5236	*45-5007	33-5401	1.00	33-5487	*45-5018
33-5081	*45-5002	33-5237	*45-5018	33-5402	*45-5009	33-5491	1.25
33-5082	*45-5027	33-5238	1.50	33-5403	1.50	33-5493	1.50
33-5083	*33-5103	33-5239	.60	33-5404	1.50	33-5497	†
33-5085	*45-5010	33-5240	2.50	33-5405	*45-5007	33-5498	*45-5009
33-5087	*33-5154	33-5241	2.50	33-5406	*45-5007	33-5499	†
33-5088	2.25	33-5244	*33-5238	33-5407	*45-5017	33-5500	*33-5394
33-5089	*45-5013	33-5247	2.25	33-5408	*45-5009	33-5503	1.75
33-5094	*33-5154	33-5248	.50	33-5410	2.25	33-5504	*45-5009
33-5097	*45-5011	33-5249	2.25	33-5411	*45-5007	33-5506	1.25
33-5099	*38-6636	33-5250	*45-5008	33-5412	*45-5009	33-5507	*33-5393
33-5101	1.25	33-5251	*67-0004	33-5413	*45-5017	33-5508	1.40
33-5102	*45-5013	33-5253	*45-5018	33-5414	*33-5409	33-5509	*45-5009
33-5103	6.00	33-5254	*45-5007	33-5415	*45-5007	33-5510	1.50
33-5105	*45-5008	33-5257	1.25	33-5416	2.25	33-5511	*45-5009
33-5106	*45-5019	33-5259	*45-5009	33-5417	2.25	33-5513	*45-5009
33-5108	*33-5119	33-5260	*33-5272	33-5418	*45-5007	33-5515	*45-5009
33-5109	*45-5008	33-5261	.50	33-5419	*45-5001	33-5516	*33-5433
33-5110	*33-5155	33-5265	1.50	33-5420	*45-5002	33-5518	*45-5009
33-5111	1.00	33-5266	*45-5007	33-5421	*45-5003	33-5519	2.00
33-5113	*45-5008	33-5268	1.75	33-5422	*45-5004	33-5521	1.70
33-5114	*45-5019	33-5269	*45-5013	33-5423	*45-5005	33-5522	2.00
33-5115	*45-5020	33-5270	2.25	33-5424	*45-5006	33-5526	1.30
33-5116	*45-5008	33-5272	1.75	33-5425	*45-5007	33-5533	1.50
33-5118	1.00	33-5273	*45-5007	33-5426	*45-5008	33-5533-1	4.00
33-5119	2.25	33-5274	*45-5007	33-5427	*45-5009	33-5535	1.25
33-5120	*45-5008	33-5275	*45-5009	33-5428	*45-5017	33-5535-2	1.00
33-5121	1.50	33-5276	1.25	33-5429	1.75	33-5535-3	1.00
33-5124	*33-5144	33-5278	2.25	33-5430	*45-5007	33-5535-4	1.25
33-5126	1.50	33-5279	*45-5007	33-5431	2.25	33-5535-5	1.25
33-5127	*45-5008	33-5280	1.85	33-5432	*45-5009	33-5535-6	1.25
33-5131	1.25	33-5281	*45-5010	33-5433	1.50	33-5535-8	*45-5009
33-5137	2.25	33-5283	*45-5009	33-5434	*45-5007	33-5535-9	2.00
33-5138	*33-5026	33-5285	2.50	33-5435	.45	33-5535-11	1.85
33-5139	1.50	33-5286	1.25	33-5436	*45-5018	33-5535-13	1.45
				33-5437	1.75	33-5535-14	1.25

* Recommended substitute.
† Refer to distributor.

ALL PRICES SUBJECT TO CHANGE WITHOUT NOTICE

RADIO PARTS PRICE LIST—Continued

PART NUMBER	LIST PRICE or Substitute	PART NUMBER	LIST PRICE or Substitute	PART NUMBER	LIST PRICE or Substitute	PART NUMBER	LIST PRICE or Substitute
33-5535-15	1.60	33-5546-12	2.25	34-8003	*34-8003-1	35-2357	.90
33-5535-16	1.25	33-5546-13	2.20	34-8003-1	1.65	35-2358	3.50
33-5535-17	1.45	33-5546-14	*33-5546-17	34-8003-2	3.00	35-2365	.35
33-5535-18	1.25	33-5546-15	2.00	34-8003-4	6.00	35-2366	4.00
33-5535-19	1.25	33-5546-16	5.75	34-8003-5	10.00	35-2367	.75
33-5535-20	1.25	33-5546-17	2.00	34-8004	7.00	35-2369	.30
33-5535-22	1.00	33-5546-18	2.40	34-8014	15.00	35-2372	.08
33-5538-1	1.10	33-5547-2	6.00			35-2375	.08
33-5538-7	*33-5538-14	33-5547-5	5.00	35-1204	22.50	35-2377	.08
33-5538-9	1.25	33-5548	2.00	35-1237	14.00	35-2378	1.50 C
33-5538-10	1.75	33-5548-1	2.75	35-1275	*45-1549	35-2384	.30
33-5538-12	1.90	33-5550-5	1.25	35-1298	15.00	35-2393	.03
33-5538-13	1.25	33-5550-6	1.25	35-1304-2	8.00	35-2396	.50
33-5538-14	1.50	33-5550-7	2.70	35-1304-4	8.00	35-2397	.15
33-5538-18	1.50	33-5550-8	1.25	35-1308	*45-9521	35-2398	2.00
33-5538-19	1.45	33-5550-9	1.45	35-1309-1	7.75	35-2400	.08
33-5538-20	2.00	33-5550-10	1.25	35-1309-2	11.00	35-2402	*35-2357
33-5538-21	1.50	33-5550-11	1.00	35-1312	15.00	35-2405	.75
33-5538-22	1.50	33-5550-12	3.00	35-1324	23.00	35-2408	.35
33-5538-23	1.25	33-5550-13	1.00	35-1329	14.00	35-2411	.08
33-5538-24	1.25	33-5554	2.25	35-1332	9.00	35-2420	.60
33-5538-26	1.25	33-5554-1	1.75	35-1332-2	7.50	35-2430	*3914
33-5538-27	1.20	33-5556-1	1.00	35-1336	13.50	35-2445	3.00
33-5538-28	1.45	33-5556-4	1.50	35-1338	10.00	35-2449	.80
33-5538-29	1.25	33-5556-5	1.10	35-1359	11.00	35-2450	*35-2460
33-5538-30	1.25	33-5556-6	1.65	35-1361	11.00	35-2453	.03
33-5538-31	1.40	33-5557	2.50	35-1371	12.00	35-2454	.75
33-5538-32	1.25	33-5557-1	4.00	35-1393	15.00	35-2455	4.00
33-5538-33	1.40	33-5557-2	1.95	35-2030	5.00	35-2456	*35-2524
33-5538-34	1.35	33-5557-3	2.00	35-2040	*35-2074	35-2460	.75
33-5538-35	1.25	33-5557-4	2.25	35-2058	*35-2284	35-2477	.08
33-5538-36	1.50	33-5558	1.85	35-2068	6.50	35-2479	*35-2524
33-5538-37	1.50	33-5561	1.45	35-2069	5.00	35-2481	.30
33-5538-38	1.35	33-5562-1	*33-5546-17	35-2076	.15	35-2493	2.00
33-5538-39	1.50	33-5563	2.25	35-2105	*315-1024	35-2497	*35-2331
33-5538-42	1.60	33-5563-2	2.25	35-2128	*35-2399	35-2515	8.50
33-5538-43	1.50	33-5563-3	2.25	35-2129	*35-2398	35-2524	7.50
33-5538-44	1.25	33-5563-4	2.25	35-2150	.05	35-2525	*35-2524
33-5538-45	1.50	33-5564	1.50	35-2204	5.00	35-2530	.03
33-5538-46	1.25	33-5564-1	1.50	35-2217	2.25	35-2538	1.10
33-5538-49	1.25	33-5564-2	1.50	35-2220	2.65	35-2541	8.50
33-5539-1	1.25	33-5564-3	1.50	35-2220-1	*35-2220	35-2545	5.25
33-5539-2	1.00	33-5565	1.25	35-2229	*56-1888	35-2547	3.75
33-5539-3	1.00	33-5565-1	1.00	35-2232	12.00	35-2548	.75
33-5539-4	1.35	33-5565-2	.90	35-2238	*35-2530	35-2549	.30
33-5539-7	1.00	33-5565-3	1.25	35-2239	.15	35-2550	.15
33-5539-8	1.10	33-5565-4	1.25	35-2242	3.00	35-2554	5.60
33-5539-9	1.10	33-5565-5	1.25	35-2245	.75	35-2556	*34-2483
33-5539-11	1.10	33-5566	1.25	35-2252	.15	35-2559	2.25
33-5539-13	1.10	33-5566-1	1.50	35-2255	.50	35-2562	.08
33-5539-15	1.10	33-5566-2	1.40	35-2257	.15	35-2563	*45-1565
33-5539-16	1.10	33-5566-4	1.50	35-2258	.15	35-2565	.08
33-5539-17	1.10			35-2270	*35-2220	35-2566	.08
33-5539-18	1.50	34-2031	*6608	35-2272	.20	35-2569	4.00
33-5539-19	1.00	34-2038	*34-2039	35-2273	1.85	35-2571	1.85
33-5539-21	1.25	34-2039	.09	35-2274	2.60	35-2572	.90
33-5539-22	1.75	34-2040	.09	35-2277	1.60	35-2574	2.25
33-5539-23	1.50	34-2047	*3463	35-2279	.09	35-2575	.35
33-5539-25	1.10	34-2064	.09	35-2280	.05	35-2577	.35
33-5539-26	1.25	34-2065	.15	35-2282	.20	35-2578	.90
33-5539-28	1.10	34-2068	.09	35-2284	.90	35-2579	1.10
33-5539-33	1.00	34-2081	*34-2064	35-2286	1.85	35-2581	1.50
33-5539-42	.90	34-2085	*34-2040	35-2291	*35-2372	35-2582	.50
33-5539-43	1.25	34-2150	*34-2065	35-2295	*35-2453	35-2585	.20
33-5539-46	1.25	34-2192	*34-2068	35-2302	.05	35-2586	.15
33-5539-48	1.00	34-2210	*34-2064	35-2303	.15	35-2589	.15
33-5539-51	1.25	34-2221	.09	35-2310	.10	35-2594	.15
33-5539-52	1.00	34-2246	.09	35-2311	.10	35-2597	*217-1057
33-5540	1.60	34-2397	.30	35-2312	1.50	35-2598	*28-4468
33-5543	2.50	34-2402	*34-2482	35-2326	.35	35-2606	*218-1502
33-5546	2.25	34-2408	*34-2478	35-2327	1.35	35-2608	*35-2581
33-5546-1	3.00	34-2432	.35	35-2330	.09	35-2613	.20
33-5546-3	2.00	34-2477	*34-2605	35-2331	2.25	35-2615	1.10
33-5546-4	2.25	34-2478	.45	35-2335	1.35	35-2616	2.25
33-5546-5	2.50	34-2482	1.00	35-2339	7.00	35-2617	.15
33-5546-6	1.75	34-2483	1.00	35-2340	.60	35-2623	*76-2379
33-5546-7	2.75	34-2484	.15	35-2353	*35-2220	35-2624	*28-8953
33-5546-8	2.50	34-2493	.25	35-2355	1.10	35-2636	.20
33-5546-10	1.75	34-2605	.15	35-2356	*35-2449	35-2638	*45-1596

* Recommended substitute.

ALL PRICES SUBJECT TO CHANGE WITHOUT NOTICE

RADIO PARTS PRICE LIST—Continued

PART NUMBER	LIST PRICE or Substitute	PART NUMBER	LIST PRICE or Substitute	PART NUMBER	LIST PRICE or Substitute	PART NUMBER	LIST PRICE or Substitute
35-2639	6.00	36-1492	*36-1469-1	36-1609-10	9.00	38-5083-10	7.50 C
35-2641	12.00	36-1504	*45-0002-5	36-1609-12	8.75	38-5418	*33-3226
35-2642	4.00	36-1505	*36-1469-1	36-1610-1	14.00	38-5511	1.70
35-2643	4.40	36-1506	*45-0002-1	36-1610-2	12.00	38-6022	1.80
35-2644	*45-1534	36-1507	*36-1507-3	36-1611	16.00	38-6777	*38-6850
35-2648	17.00	36-1507-1	16.00	36-1611-2	16.00	38-6850	1.10
35-2650	2.40	36-1507-2	7.00	36-1611-3	14.00	38-7693	*45-3003
35-2655	1.30	36-1507-3	6.25	36-1612	29.50	38-8060	.12
35-2656	1.80	36-1507-4	6.50	36-1612-1	9.25	38-8198	.15
35-2658	9.25	36-1508	12.00	36-1613	*45-0004	38-8221	.20
35-2661	*45-1596	36-1509	*36-1602	36-1613-1	11.25	38-8416	*95-0227
35-2662	2.40	36-1510	*45-0002-5	36-1613-2	*45-0004	38-8596	1.80
35-2663	11.00	36-1511	*45-0002-1	36-1613-3	*45-0004	38-8689	.10
35-2663-2	10.00	36-1512	*36-1469-1	36-1613-5	5.50	38-8764	.10
35-2664FCSS	2.10	36-1514	*45-0006-1	36-1614	7.00	38-8803	.08
35-2667-1	3.25	36-1515	*36-1530	36-1614-4	*36-1614	38-8912	10.00
35-2670	*45-1597	36-1516	*45-0002-1	36-1615	8.00	38-8925	.25
35-2671-1	5.00	36-1517	*45-0001	36-1615-1	7.30	38-9161-7	6.50 C
35-2671-2	*35-2671-1	36-1518	*45-0007	36-1615-2	6.00	38-9408	*38-9438
35-2672	1.85	36-1519	*45-0004-1	36-1615-8	7.50	38-9415	*38-4401
35-2674	9.50	36-1520	*45-0002	36-1615-9	7.75	38-9438	.35
35-2675	13.50	36-1522	*45-0007	36-1617	7.50	38-9562	.80
35-2675-1	*35-2675	36-1523	*36-1535	36-1617-1	*36-1617-2	38-9702	*27-4767
35-2676	2.20	36-1524	*45-0006-1	36-1617-2	6.50	38-9704	12.50
35-2676-1FC66	*45-1611	36-1528	*45-0006-1	36-1622	10.00	38-9729	.10
35-2678	*45-1613	36-1530	15.00	36-1622-1	7.00	38-9732	*38-9932
35-2681	12.00	36-1533	*36-1591	36-1622-2	*36-1622-1	38-9744	.15
35-2683	2.00	36-1535	14.00	36-1625	7.50	38-9760	1.10
35-2684	2.75	36-1536	*45-0001	36-1625-3	*36-1625	38-9761	2.25
35-2685	2.00	36-1537	13.00	36-1625-6	6.25	38-9778	.08
35-2686	14.00	36-1538	*45-0002-1	36-1625-7	7.50	38-9851-2	.70
35-2690	13.00	36-1540	*45-0002-1	36-1626	6.25	38-9851-3	.45
35-3048	3.75	36-1541	10.00	36-1626-1	8.50	38-9851-4	.40
35-3052	1.10	36-1542	*36-1592	36-1626-3	10.00	38-9851-5	.60
35-3065	3.75	36-1543	*36-1570	36-1627	5.00	38-9851-6	.35
35-3066	5.50	36-1544	*36-1591	36-1627-1	8.50	38-9851-7	*38-9851-5
35-3066-1	4.00	36-1545	*45-0002	36-1627-4	8.50	38-9851-8	.50
35-3066-2	4.00	36-1547	*45-0002-1	36-1627-5	5.00	38-9851-10	.50
35-4077	12.50	36-1548	*36-1570	36-1629	7.00	38-9870	.30
35-4078	12.50	36-1550	*36-1593	36-1629-1	8.00	38-9883FA33	.75
35-5077	11.00	36-1551	*45-0004-1	36-1629-2	8.50	38-9890	5.25
35-5078	*35-5077	36-1552	*36-1590	36-1630	30.00	38-9894	4.25
		36-1559	*36-1591	36-1631	9.00	38-9904	.20
36-1330	*45-0004	36-1562	10.00	36-1632	8.00	38-9909	*45-6307
36-1345	*45-0004-2	36-1564	*45-0007-2	36-3061	*36-3631	38-9910A	5.75
36-1362	*45-0004-3	36-1565	*45-0006-1	36-3160	.20	38-9911	*45-6307
36-1367	*45-0004-3	36-1567	*45-0005-2	36-3321	*36-3381	38-9912A	3.75
36-1368	*45-0004	36-1569	*45-0007-2	36-3381	2.00	38-9913	*38-9912
36-1411	*73-0056	36-1570	11.00	36-3382	*36-3631	38-9922	.75
36-1435	*45-0002-1	36-1571	*45-0002-5	36-3399	*217-1057	38-9942	.15
36-1437	*45-0007-2	36-1574	*36-1469-1	36-3406	*36-3485	38-9990	1.50
36-1438	*45-0006-3	36-1575	*45-0006-1	36-3485	.70		
36-1440	*45-0005-2	36-1578	12.50	36-3560	*36-3160	39-7920	.02
36-1442	*45-0002-1	36-1579	*45-0004	36-3627	1.20	39-7981	.35
36-1444	*45-0002-7	36-1580	10.50	36-3631	2.00	39-8409	*39-8595
36-1445	*45-0005-4	36-1581	*36-1587	36-3796	*36-3627		
36-1447	*36-1508	36-1585	7.50	36-3798	*36-3631	40-6383	*45-1469
36-1449	*45-0005-2	36-1586	*45-0007	36-3799	*36-3381	40-6475	*40-6673
36-1451	*45-0002-1	36-1587	12.00	36-3900	*45-2607	40-6489	2.25
36-1453	11.50	36-1590	*45-0006-1	36-3901	*45-2607	40-6572	*45-1546
36-1455	*36-1508	36-1591	12.00	36-4091	*36-4087	40-6595	*40-6673
36-1455-1	9.75	36-1592	9.00	36-4096	*36-4093	40-6598	*40-6627
36-1456	*45-0006	36-1593	9.00	36-4115	1.25	40-6612	2.75
36-1457	*36-1508	36-1595	14.00	36-4128	*36-4120	40-6627	4.00
36-1459	*45-0007-1	36-1596	*45-0006-1	36-4135	*36-4172	40-6660	1.25
36-1469	*36-1469-1	36-1597	*36-1598	36-4151	*36-4089	40-6663	.90
36-1469-1	4.25	36-1598	7.00	36-4158	1.50	40-6673	.90
36-1475	*45-0006-5	36-1600	*36-1591	36-4162	*36-4163	40-6674	1.00
36-1478	*45-0002-5	36-1601	7.50	36-4163	1.25	40-6685	4.00
36-1479	*45-0006-1	36-1602	12.00	36-4183	*36-4115	40-6686	4.00
36-1480	*45-0005-2	36-1604	*36-1587	36-4201	*36-4175	40-6696	4.00
36-1481	*45-0002-1	36-1604-1	8.00	36-4203	*36-4192	40-6739	1.00
36-1482	*45-0002-1	36-1606	*36-1595	36-4221	*36-4211	40-6740	3.50
36-1483	*45-0004-1	36-1608	9.75			40-6742	3.00
36-1484	*45-0002-5	36-1609	*36-1609-10	37-6512	45.00	40-6745	1.80
36-1485	*36-1459	36-1609-2	7.75			40-6746	.60
36-1487	*36-1513	36-1609-3	7.00	38-5036	*83-0026	40-6747	1.25
36-1488	*36-1508	36-1609-4	9.25	38-5082	*33-5009	40-6754	2.60
36-1489	*45-0006-5	36-1609-5	*36-1609-2	38-5083-8	.05	40-6763	1.50
36-1491	*45-0007-2	36-1609-6	*36-1609-3	38-5083-9	.10	40-6766	.25

* Recommended substitute.

ALL PRICES SUBJECT TO CHANGE WITHOUT NOTICE

RADIO PARTS PRICE LIST—Continued

PART NUMBER	LIST PRICE or Substitute	PART NUMBER	LIST PRICE or Substitute	PART NUMBER	LIST PRICE or Substitute	PART NUMBER	LIST PRICE or Substitute
40-6769	1.25	40-7539	.40	41-3714-2	.60	41-3794	.25
40-6770	3.25	40-7546	.30	41-3714-3	.50	41-3795	1.15
40-6771	2.85	40-7547	2.00	41-3723	1.50	41-3796	.70
40-6772	4.00	40-7548	5.00	41-3723-1	*41-3723	41-3801	1.25
40-6774	*40-6779	40-7550	1.30	41-3728	1.25	41-3801-1	1.25
40-6776	1.50	40-7560	.35	41-3730	14.00	41-3801-2	.95
40-6779	.45	40-7562	4.00	41-3731	6.00	41-3801-6	.75
40-6781	1.70	40-7562-1	4.50	41-3732	1.00	41-3801-7	1.50
40-6783	1.35	40-7575	3.25	41-3734	.80	41-3802	.20
40-6784	2.60	40-7575-1	3.25	41-3734-1	1.60	41-3805	4.00
40-6785	2.25	40-7583	.65	41-3734-2	1.35	41-3805-1	2.00
40-6786	5.50	40-7592	4.00	41-3734-3	1.35	41-3806-6	.50
40-6787	1.10	40-7592-1	3.75	41-3734-6	1.00	41-3820	1.00
40-6795	2.40	40-7598	3.50	41-3734-7	1.50	41-3821-6	.85
40-6796	2.40	40-7600	3.50	41-3734-8	1.00	41-3821-13	1.60
40-6798	1.60	40-7605	.60	41-3734-9	1.15	41-3830	1.10
40-6799	1.50	40-7605-1	.60	41-3734-11	1.25	41-3831	5.50
40-6817	.85	40-7606	12.50	41-3735	1.40	41-3837	.75
40-6820	4.80	40-7618	6.00	41-3735-1	1.50	41-3837-1	.75
40-6822	.45	40-7639	2.75	41-3735-2	1.50	41-3842	.50
40-6825	3.75	40-7644	2.50	41-3735-5	.60	41-3844	3.75
40-6827	1.85	40-7668	4.00	41-3735-9	.75	41-3858	1.20
40-6830	5.00	40-7674	3.00	41-3735-10	.75	41-3860	1.75
40-6831	8.00	40-8545-1	8.00	41-3735-11	.60	41-3860-1	1.50
40-6853	.45	40-8545-2	10.00	41-3737	.90	41-3860-2	1.75
40-6862	8.00	40-9161	.85	41-3737-1	1.00	41-3862	.40
40-6901	.50	40-9161-1	.90	41-3737-2	.60	41-3862-1	.40
40-6904	*40-6948			41-3737-3	.35	41-3862-2	.45
40-6905	.30	41-3170	*83-0026	41-3738	.80	41-3863	1.50
40-6906	.70	41-3176	*41-3472	41-3738-2	.70	41-3864-1	1.15
40-6909	1.00	41-3186	*83-0026	41-3742	.85	41-3864-2	1.25
40-6910	.60	41-3187-1	.50	41-3742-3	.90	41-3865	1.40
40-6911	.75	41-3187-2	.80	41-3742-5	.60	41-3868-1	1.00
40-6922	4.00	41-3193	*83-0026	41-3742-6	.45	41-3869	1.50
40-6926	3.00	41-3198	2.00	41-3746	*41-3796	41-3869-1	1.35
40-6927	8.50	41-3203	2.00	41-3747-17	.45	41-3869-2	1.50
40-6927-1	*40-6927	41-3204	1.80	41-3748	1.85	41-3869-5	1.50
40-6929	.40	41-3222	*38-9910	41-3751	.20	41-3869-7	1.25
40-6930	1.50	41-3250	1.80	41-3753	4.00	41-3869-9	1.00
40-6932	6.75	41-3300	*38-9910	41-3754	.30	41-3870	1.00
40-6933	4.80	41-3387	.20	41-3754-1	.30	41-3892	3.50
40-6937	*40-6956	41-3403	*83-0026	41-3754-2	.30	41-3894	2.25
40-6938	.40	41-3477-1	1.00	41-3754-3	.30	41-3896	1.25
40-6939	3.50	41-3478	*41-3505	41-3754-4	.35	41-3905	1.75
40-6940	.30	41-3505	1.00	41-3754-5	.30	41-3910-4	.40
40-6943	.45	41-3540	1.00	41-3754-6	.60	41-3910-5	.50
40-6945	.50	41-3545	*27-4788	41-3754-10	.50	41-3910-6	.40
40-6945-1	.50	41-3550	.80	41-3754-11	.23	41-3910-7	.35
40-6948	.20	41-3551	.20	41-3754-12	1.00	41-8009	.45
40-6951	2.75	41-3553	7.25	41-3754-13	.45		
40-6951-1	2.25	41-3554	1.10	41-3754-14	.90	42-1029	*42-1035
40-6954	1.75	41-3570	1.00	41-3754-15	.30	42-1030	*42-1035
40-6956	.50	41-3571	.60	41-3754-16	.25	42-1035	1.25
40-6958	11.00	41-3576	*41-36481	41-3755-10	.85	42-1036	*42-1632
40-6958-1	11.00	41-3589	2.50	41-3755-11	*L-2183	42-1040	1.00
40-6961	4.50	41-3624	1.25	41-3755-12	.85	42-1053	1.25
40-6963	2.00	41-3635	3.00	41-3755-13	.85	42-1067	*42-1053
40-6964	1.75	41-3637	3.00	41-3755-16	.85	42-1080	*42-1632
40-6965	.35	41-3660	*41-3601	41-3755-17	.85	42-1118	3.75
40-6968	2.00	41-3669	*41-3710	41-3755-19	.85	42-1119	.75
40-6968-1	2.50	41-3672	.70	41-3759	.15	42-1123	*42-1194
40-6981	9.00	41-3673	.80	41-3764-1	3.25	42-1140	*42-1225
40-6991	3.50	41-3679	.75	41-3771-1	1.20	42-1149	*42-1225
40-6991-1	4.00	41-3681	.30	41-3771-2	1.00	42-1156	.35
40-6991-2	6.50	41-3683	.30	41-3771-3	1.35	42-1159	*42-1160
40-6998	4.50	41-3685	1.25	41-3772-1	4.00	42-1160	.35
40-6998-1	3.50	41-3687	.70	41-3772-2	2.75	42-1170	*42-1200
40-6999	4.80	41-3701	1.85	41-3772-3	2.90	42-1172	*42-1246
40-7475	6.25	41-3704	1.35	41-3777	2.25	42-1173	.75
40-7504	3.25	41-3708	.65	41-3779	12.00	42-1180	*42-1182
40-7509	2.75	41-3709	1.25	41-3780	*45-1541	42-1181	*42-1182
40-7509-1	2.25	41-3710	.75	41-3781	.90	42-1182	1.60
40-7512	4.75	41-3712	.45	41-3783	3.30	42-1184	2.00
40-7518	*40-7606	41-3712-1	.75	41-3784	1.70	42-1192	.75
40-7523	4.00	41-3712-2	.50	41-3785	.75	42-1194	.90
40-7524	*40-7606	41-3712-3	.45	41-3786	5.50	42-1195	2.75
40-7525	.45	41-3712-4	.50	41-3786-1	3.75	42-1196	2.00
40-7535	.35	41-3713	.50	41-3791	.25	42-1200	1.80
40-7538	3.25	41-3714	.35	41-3791-1	.40	42-1207	1.80
40-7538-1	3.50	41-3714-1	.75	41-3793	2.25	42-1215	.45

* Recommended substitute.

ALL PRICES SUBJECT TO CHANGE WITHOUT NOTICE

RADIO PARTS PRICE LIST—Continued

PART NUMBER	LIST PRICE or Substitute	PART NUMBER	LIST PRICE or Substitute	PART NUMBER	LIST PRICE or Substitute	PART NUMBER	LIST PRICE or Substitute
42-1216	1.10	42-1553-1	.90	42-1683	3.25	42-1806	.90
42-1217	3.00	42-1553-3	.60	42-1684	3.75	42-1809	3.00
42-1221	.60	42-1555	1.35	42-1688	4.50	42-1811	1.35
42-1224	2.00	42-1557	*42-1655	42-1689	10.00	42-1813	6.00
42-1225	1.00	42-1562	.45	42-1690	6.00	42-1814	1.40
42-1241	1.50	42-1564	4.50	42-1691	6.00	42-1816-1	2.25
42-1245	1.80	42-1569	.30	42-1692	7.00	42-1817	1.25
42-1246	1.80	42-1574	.50	42-1693	5.60	42-1818	22.00
42-1255	2.40	42-1576	*42-1695	42-1695	6.00	42-1819	7.00
42-1257	1.50	42-1578	3.25	42-1696	4.00	42-1820	3.75
42-1267	1.10	42-1581	1.10	42-1697	1.50	42-1821	1.10
42-1268	1.50	42-1582	4.80	42-1698	1.00	42-1822	1.00
42-1269	1.10	42-1583	1.85	42-1699	1.50	42-1823	2.10
42-1274	1.85	42-1584	1.50	42-1700	1.10	42-1824	1.25
42-1282	1.10	42-1585	2.00	42-1701	10.00	42-1824-1	1.25
42-1290	1.10	42-1586	2.50	42-1702	.60	42-1824-2	1.00
42-1314	*42-1283	42-1587	6.50	42-1703	5.60	42-1825	25.00
42-1319	1.85	42-1588	1.50	42-1704	5.60	42-1827	6.00
42-1320	2.10	42-1589	3.00	42-1705	8.00	42-1828	3.00
42-1325	1.10	42-1590	1.25	42-1706	8.00	42-1834	.95
42-1326	1.50	42-1591	4.80	42-1709	1.00	42-1834-1	1.00
42-1327	*42-1346	42-1592	5.50	42-1710	10.00	42-1834-2	1.00
42-1331	.90	42-1593	1.85	42-1711	11.00	42-1837	.90
42-1335	1.70	42-1594	1.35	42-1712	2.00	42-1837-2	1.00
42-1339	1.10	42-1598	1.85	42-1714	.60	42-1837-3	1.00
42-1341	1.50	42-1599	2.60	42-1715	1.00	42-1840	.85
42-1346	1.50	42-1600	1.00	42-1716	.70	42-1842	3.00
42-1351	1.50	42-1602	3.00	42-1717	.60	42-1843	3.00
42-1356	2.25	42-1603	1.50	42-1720	2.00	42-1846	2.75
42-1358	1.10	42-1605	*42-1598	42-1721	2.25	42-1847	1.00
42-1360	1.50	42-1606	4.50	42-1722	*42-1520	42-1847-1	1.00
42-1362	4.50	42-1608	*42-1695	42-1723	.55	42-1848	1.10
42-1363	*42-1393	42-1609	*42-1523	42-1724	*42-1600	42-1848-1	.75
42-1368	.50	42-1610	*6498	42-1725	2.50	42-1856	2.50
42-1369	.50	42-1611	.30	42-1730	1.40	42-1857	1.65
42-1374	.50	42-1618	4.50	42-1731	4.00	42-1858	2.75
42-1393	1.50	42-1620	6.00	42-1734	3.75	42-1860	.40
42-1399	1.10	42-1621	6.00	42-1735	1.10	42-1861	3.00
42-1406	*42-1562	42-1626	*45-1452	42-1736	.70	42-1862	*42-1874
42-1443	*42-1444	42-1627	6.50	42-1737	4.50	42-1863	.90
42-1444	1.10	42-1628	1.10	42-1738	1.75	42-1864	1.40
42-1446	4.50	42-1630	.35	42-1741	18.75	42-1865	1.00
42-1451	6.00	42-1631	4.80	42-1742	20.50	42-1869	1.60
42-1452	8.50	42-1632	1.50	42-1745-1	.85	42-1870	2.00
42-1454	2.25	42-1633	1.35	42-1745-2	1.00	42-1872	2.25
42-1461	5.60	42-1635	3.75	42-1745-3	.85	42-1873	.60
42-1467	*42-1517	42-1637	2.60	42-1747	25.00	42-1874	1.35
42-1469	2.00	42-1638	1.10	42-1749-1	2.55	42-1876	1.25
42-1474	6.00	42-1639	*42-1702	42-1750-1	.35	42-1877	4.25
42-1477	4.00	42-1640	*42-1647	42-1750-3	.25	42-1879	3.50
42-1479	*42-1545	42-1642	2.60	42-1752	1.90	42-1879-1	3.50
42-1485	4.50	42-1644	1.50	42-1753	1.40	42-1880	2.25
42-1489	6.00	42-1645	2.25	42-1756	7.50	42-1881	5.50
42-1493	4.50	42-1647	1.85	42-1758	4.10	42-1882	4.50
42-1494	.90	42-1648	*42-1693	42-1758-1	6.00	42-1883	24.00
42-1495	1.50	42-1650	1.10	42-1761	6.00	42-5336	.70
42-1497	.50	42-1651	*42-1654	42-1762	8.00	42-5362	.75
42-1498	*42-1632	42-1652	3.75	42-1763	6.00	42-5564	*42-1160
42-1501	*42-1523	42-1654	1.00	42-1764	5.60	42-5606	*42-1215
42-1502	1.00	42-1655	*42-1654	42-1769	2.75	42-5843	*85-0118
42-1505	1.00	42-1656	5.25	42-1770	.80	42-5848	*85-0118
42-1509	*42-1053	42-1657	.45	42-1772	1.85	42-5849	.30
42-1512	*42-1477	42-1660	12.00	42-1773	2.00	42-5865	16.00
42-1516	2.25	42-1661	12.75	42-1774	10.00	42-5866	12.00
42-1517	1.10	42-1664	.90	42-1776	4.60		
42-1520	1.50	42-1665	1.50	42-1777	12.00	43-4398	†
42-1521	*42-1655	42-1668	2.00	42-1780	2.90	43-4501	†
42-1523	1.00	42-1670	1.50	42-1784	1.00	43-4502	†
42-1524	1.25	42-1671	1.50	42-1785	1.25	43-4699	†
42-1525	5.00	42-1672	3.00	42-1786-1	5.50	43-4922	†
42-1527	4.50	42-1673	2.25	42-1787	*76-2140-2	43-4953	†
42-1528	4.00	42-1674	2.25	42-1788	6.00		
42-1533	*42-1053	42-1675	4.00	42-1789	.70	44-1568	.20
42-1535	*42-1611	42-1676	.60	42-1791	1.85	44-1597	.20
42-1536	*42-1655	42-1677	3.50	42-1793	3.85	44-1631	.15
42-1543	*42-1548	42-1678	2.60	42-1800	6.50		
42-1545	.70	42-1679	.55	42-1801	5.60	45-0001	4.00
42-1548	1.50	42-1680	2.25	42-1803	6.00	45-0001-1	7.00
42-1551	*42-1523	42-1681	7.50	42-1803-1	6.00	45-0002	4.50
42-1553	*42-1553-1	42-1682	1.50	42-1803-2	5.50	45-0002-1	6.50

* Recommended substitute.

† Refer to distributor.

ALL PRICES SUBJECT TO CHANGE WITHOUT NOTICE

RADIO PARTS PRICE LIST—Continued

PART NUMBER	LIST PRICE or Substitute	PART NUMBER	LIST PRICE or Substitute	PART NUMBER	LIST PRICE or Substitute	PART NUMBER	LIST PRICE or Substitute
45-0002-2	5.00	45-1533	2.50	45-2313	1ea45-2378	45-3008	1.95
45-0002-3	5.40	45-1534	1.50		1ea28-5361	45-3008A	1.95
45-0002-4	5.40	45-1535	.75	45-2324	3.75	45-3009	1.70
45-0002-5	5.40	45-1541	11.25	45-2329	.75	45-3010	1.90
45-0002-6	*45-0002-7	45-1541-1	22.50	45-2330	1.80	45-3011	2.40
45-0002-7	5.40	45-1545	3.95	45-2350	.20	45-3012	3.25
45-0003	5.25	45-1546	12.50	45-2364	*27-5011	45-3013	17.50
45-0003-1	5.60	45-1547	†	45-2378	1.10	45-3014	.90
45-0003-2	5.60	45-1548	18.00	45-2381	2.60	45-3015	1.15
45-0004	6.50	45-1549	14.00	45-2401	1.00	45-3016	1.35
45-0004-1	6.25	45-1550	†	45-2424	.75	45-3017-22	1.75
45-0004-2	6.25	45-1552	*45-1596	45-2429	.60	45-3017-23	2.15
45-0004-3	6.25	45-1552-1	*45-1596	45-2475	.70	45-3017-24	2.40
45-0005	8.00	45-1553	12.00	45-2477	.30	45-3017-25	2.80
45-0005-1	8.00	45-1554	8.50	45-2481	.75	45-3017-26	2.70
45-0005-2	8.00	45-1555	25.00	45-2540	20.00	45-3017-27	4.00
45-0005-3	*45-0005-4	45-1556	25.00	45-2559	.05	45-3017-28	4.50
45-0005-4	8.00	45-1557	25.00	45-2607	2.25	45-3017-29	4.75
45-0006	14.50	45-1560	5.50	45-2610	.60	45-3017-30	3.75
45-0006-1	14.00	45-1560C	5.50	45-2656-2	.35	45-3018-8	1.10
45-0006-3	14.00	45-1561	*45-1561-1	45-2656-8	.25	45-3018-9	1.45
45-0006-5	14.00	45-1561-1	3.25	45-2659	.10	45-3018-19	1.15
45-0007	13.00	45-1562	3.95	45-2712	*27-5105	45-3018-23	1.50
45-0007-1	12.00	45-1563	7.95	45-2717	.75	45-3018-24	2.00
45-0007-2	12.00	45-1563-1	3.95	45-2766	1.85	45-3018-26	.70
45-0007-3	12.00	45-1564	5.25	45-2772	.35	45-3018-27	.85
45-1115	5.50	45-1565	4.00	45-2773	.30	45-3018-28	.88
45-1135	2.50	45-1568	†	45-2774	.50	45-3018-29	1.75
45-1175	.50	45-1569	*45-1569C	45-2775	.35	45-3018-30	1.15
45-1281	*45-1527	45-1569C	12.95	45-2777	.10	45-3019	5.35
45-1407	.50	45-1570	3.50	45-2783	.80	45-3019-1	5.60
45-1419	*27-4816	45-1570-1	3.50	45-2784	.70	45-3020	6.95
45-1420	2.50	45-1571	.65	45-2802	.45	45-3020-1	7.25
45-1452	.80	45-1572	.90	45-2806	.35	45-3021	2.49
45-1459	*45-8755-12	45-1572-1	1.65	45-2824	1.25	45-3026	*91.0256
45-1460	.90	45-1574	3.25	45-2827	.09	45-3028	7.75
45-1462	7.95	45-1574-1	2.75	45-2828	.09	45-3030	.75
45-1464	5.50	45-1575	†	45-2836	.09	45-3031	.15
45-1465	4.00	45-1576	†	45-2851	2.75	45-3500	.35
45-1466	1.40	45-1577	.85	45-2894	2.75	45-3500-1	.25
45-1467	.30	45-1578	1.50	45-2900	.30	45-3500-2	.25
45-1468-1	15.00	45-1579	35.00	45-2934	*5563-12	45-3500-3	.35
45-1469	2.25	45-1580	19.50	45-2948	2.75	45-3500-4	.55
45-1470	4.50	45-1581	†	45-2949	*45-1565	45-3500-5	.25
45-1477	.45	45-1582	12.25	45-2953	2.75	45-3500-6	.25
45-1479	*45-1534	45-1582-1	9.75	45-2957	2.75	45-3500-7	.25
45-1482	10629B	45-1583	18.75	45-2959	3.75	45-3500-8	.35
45-1483	10629C	45-1583-1	16.25	45-2972	*45-1420	45-3500-9	.65
45-1484	10618A	45-1584	7.95	45-2973	*45-1135	45-3500-10	.75
45-1485	10524P	45-1584-1	5.25	45-2974	*45-8755-12	45-3500-11	.50
45-1486	10524R	45-1585	5.50	45-2978	*AD-1017	45-3500-12	.50
45-1487	10524T	45-1586	15.95	45-2982	1.50	45-3500-13	.50
45-1488	1.40	45-1590	7.00	45-2983	2.10	45-3500-14	.80
45-1489-25	4.80	45-1590-1	4.50	45-2984	3.00	45-3500-15	.75
45-1489-30	6.00	45-1591	3.00	45-2985	6.95	45-3500-16	.55
45-1492	5.50	45-1593	†	45-2987	5.95	45-3500-17	.55
45-1493	3.25	45-1594	*45-1594-1	45-2988	*45-3019	45-3500-18	.55
45-1494	2.25	45-1594-1	2.50	45-2989	*45-2989-1	45-3500-19	.30
45-1495	10.00	45-1595	†	45-2989-1	4.95	45-3500-21	.60
45-1495-1	20.00	45-1596	2.25	45-2991	*45-1460	45-3501	.35
45-1496	2.95	45-1597	1.50	45-2995	*45-1546	45-3502	.25
45-1498	.20	45-1598	5.95	45-3001	.75	45-3504	*30-4650-29
45-1499	.20	45-1609	*45-9530	45-3002	.90	45-3504-1	*30-4650-34
45-1500	40.00	45-1612	3.75	45-3003	1.70	45-3504-2	*30-4650-34
45-1501	50.00	45-1613	1.00	45-3004	1.50	45-3504-3	*30-4650-44
45-1502	8.00	45-1614	†	45-3005	1.30	45-3504-4	*30-4650-45
45-1503	9.00	45-1618	25.75	45-3005A	1.30	45-3504-5	*30-4650-45
45-1513	9.00	45-1619	34.25	45-3005-1	1.50	45-3504-6	*30-4650-46
45-1514	7.50	45-1623	5.95	45-3005-2	1.45	45-3504-7	*30-4650-49
45-1515	1.75	45-2016	.09	45-3005-4	1.25	45-3504-8	*30-4650-49
45-1519	.64	45-2017	.15	45-3005-5	1.60	45-3504-9	*30-4650-51
45-1523	*45-1561	45-2046	.08	45-3005-6	1.70	45-3504-10	*30-4650-54
45-1524	*45-1562	45-2062	3.00	45-3005-7	2.40	45-3504-11	*30-4650-55
45-1525	8.95	45-2113	.35	45-3005-8	2.25	45-3504-12	*30-4650-56
45-1527	3.35	45-2116	.80	45-3005-9	2.25	45-3504-13	*30-4650-56
45-1528	42.00	45-2117	*45-6316	45-3005-10	2.40	45-3504-14	*30-4650-57
45-1529	30.00	45-2142	2.50	45-3006	2.10	45-3504-15	*30-4650-57
45-1530	18.00	45-2143	.50	45-3006A	2.10	45-3504-16	*30-4650-60
45-1531	9.00	45-2149	3.00	45-3007	1.55	45-3504-17	*30-4650-61
45-1532	3.50	45-2307	5.25	45-3007A	1.55	45-3504-18	*30-4650-62

* Recommended substitute.

† Refer to distributor.

ALL PRICES SUBJECT TO CHANGE WITHOUT NOTICE

RADIO PARTS PRICE LIST—Continued

PART NUMBER	LIST PRICE or Substitute	PART NUMBER	LIST PRICE or Substitute	PART NUMBER	LIST PRICE or Substitute	PART NUMBER	LIST PRICE or Substitute
45-3504-19	*30-4650-62	45-5032	1.25	45-6301	1.70	45-6389-2	1.75
45-3504-20	*30-4650-63	45-5033	1.25	45-6305	1.70	45-6389-3	2.00
45-3504-21	*30-4650-66	45-5034	1.25	45-6306	1.70	45-6390	.45
45-3504-22	*30-4650-68	45-5035	1.25	45-6307	3.50	45-6391	3.50
45-3504-23	*30-4650-89	45-5036	1.25	45-6307A	3.50	45-6392	18.00
45-3504-24	*30-4650-90	45-5037	1.25	45-6308	14.00	45-6393	17.00
45-3504-25	*30-4650-90	45-5038	1.25	45-6309	15.00	45-6394	15.00
45-3504-26	*30-4650-91	45-5039	1.25	45-6310	4.50	45-6395	15.00
45-3504-27	*30-4650-91	45-5040	1.25	45-6315	.65	45-6396	14.00
45-3504-28	*30-4650-94	45-5041	1.25	45-6316	.15	45-6397	15.50
45-3504-29	*30-4650-95	45-5042	1.25	45-6318	*8611-2	45-6398	20.00
45-3504-30	*30-4650-96	45-6002	.08	45-6319	*8611-3	45-6399	3.00
45-3504-31	*30-4650-120	45-6002.1	7.50 C	45-6320	*10623	45-6400	31.25
45-3504-32	*30-4650-122	45-6003	.05	45-6324	*10631	45-6401	15.00
45-3504-33	*30-4650-123	45-6003-1	2.00 C	45-6325	*10632B	45-6402	16.00
45-3504-34	*30-4650-124	45-6036	.60	45-6326	*10639	45-6403	20.00
45-3504-35	*30-4650-124	45-6041	.02	45-6328	*10641A	45-6404	20.00
45-3504-36	*30-4650-125	45-6042	.15	45-6331	*10647E	45-6405	2.50
45-3504-37	*30-4650-125	45-6061	.60	45-6338	1.38	45-6406	.65
45-3504-38	*30-4650-126	45-6067	.35	45-6338-1	.70	45-6409	14.00
45-3504-39	*30-4650-47	45-6105	*45-0005-2	45-6338-2	.68	45-6410	12.00
45-3504-40	*30-4650-52	45-6118	.60	45-6338-3	.80	45-6411	45.00
45-3504-41	*30-4650-58	45-6120	1.45	45-6338-4	.90	45-6412	13.00
45-3504-42	*30-4650-64	45-6153	*45-0005-4	45-6338-5	1.05	45-6413	12.00
45-3504-43	*30-4650-53	45-6157	*36-1590	45-6339	.55	45-6414	16.00
45-3504-44	*30-4650-86	45-6159	*36-1590	45-6340	.85	45-6415	25.00
45-3504-45	*30-4650-92	45-6160	*45-0005-2	45-6341	.76	45-6416	*45-1579
45-3504-46	*30-4650-98	45-6166	*45-0005-2	45-6341-1	.86	45-6417	*45-1579
45-3504-47	*30-4650-93	45-6167	*45-0005-4	45-6341-2	.90	45-6418	1.70
45-4000	.75	45-6168	*45-0005-4	45-6342	1.00	45-6419	17.00
45-4000-1	.75	45-6182	.35	45-6343	.90	45-6421	14.00
45-4000-2	.75	45-6190	.12	45-6343-1	1.05	45-6422	14.50
45-4000-3	1.25	45-6196	.03	45-6343-2	1.40	45-6423	3.50
45-4000-4	1.05	45-6200	.25	45-6344	1.12	45-6424	12.00
45-4000-5	1.05	45-6215	.20	45-6344-1	1.55	45-6425	9.00
45-4000-6	1.05	45-6216	.10	45-6345	.55	45-6426	17.00
45-4000-7	1.65	45-6218	*45-0005-4	45-6346	.65	45-6427	30.00
45-4000-8	1.65	45-6219	12.00	45-6347	.60	45-6428	12.00
45-4000-9	1.65	45-6224	*36-1508	45-6347-1	.66	45-6429	22.00
45-4001	1.00	45-6225	1.25	45-6348	.80	45-6430	35.00
45-4001-1	1.00	45-6226	.45	45-6348-1	.80	45-6431	60.00
45-4001-2	1.00	45-6227	2.10	45-6348-2	.80	45-6432	23.00
45-4001-3	1.00	45-6237	.60	45-6348-3	.80	45-6433	60.00
45-4001-4	1.00	45-6238	1.10	45-6348-4	.90	45-6434	24.00
45-4001-5	1.00	45-6239	.05	45-6348-5	1.00	45-6435	7.75
45-4001-6	1.00	45-6240	.05	45-6349	1.38	45-6436-12	9.00
45-4001-7	1.00	45-6244	*45-3002	45-6349-1	1.38	45-6437	4.75
45-4001-8	1.00	45-6245	*45-3003	45-6350	1.00	45-6439	12.00
45-4645-1	.05	45-6246	*45-3004	45-6351	1.45	45-6440	50.00
45-5001	1.25	45-6248	*45-3018-30	45-6351-1	1.45	45-6441	40.00
45-5002	1.25	45-6249	1.20	45-6352	.15	45-6442	16.00
45-5003	1.25	45-6250	*45-3002	45-6353	.25	45-6443	5.75
45-5004	1.25	45-6251	*45-3003	45-6353-1	.35	45-6445	17.00
45-5005	1.25	45-6252	2.00	45-6353-2	.35	45-6446	22.00
45-5006	1.25	45-6263	*45-3502	45-6354	.53	45-6447	12.00
45-5007	1.25	45-6264	*45-3018-27	45-6354-1	.55	45-6448	16.00
45-5008	1.25	45-6265	.95	45-6354-2	.58	45-6448-1	20.00
45-5009	1.25	45-6266	*30-2547	45-6358	*45-1557	45-6449	.20
45-5010	1.25	45-6268	*45-3500-5	45-6359	*45-1557	45-6449-1	.20
45-5011	1.25	45-6269	*61-0062	45-6362	3.00	45-6449-2	*56-5713-9
45-5012	1.25	45-6270	*61-0120	45-6364	2.75	45-6449-3	*56-5713-6
45-5013	1.25	45-6271	*61-0108	45-6365	4.95	45-6450	1.00
45-5014	1.25	45-6272	*61-0170	45-6366	15.00	45-6451	3.00
45-5015	1.25	45-6273	*45-3500-8	45-6369	13.75	45-6452	1.50
45-5016	1.25	45-6274	*45-3500-9	45-6370	13.50	45-6453	5.50
45-5017	1.25	45-6283	*45-5002	45-6371	5.25	45-6454	18.00
45-5018	1.25	45-6284	*45-5003	45-6372	.12	45-6455	16.00
45-5019	1.25	45-6285	*45-5006	45-6377-1	.35	45-6456	11.00
45-5020	1.25	45-6286	*45-5007	45-6378	4.00	45-6457	20.00
45-5021	1.25	45-6287	*45-5008	45-6379	.50	45-6458	10.00
45-5022	1.25	45-6288	*45-5008	45-6380	15.00	45-6459	12.50
45-5023	1.25	45-6289	*45-5008	45-6381	5.60	45-6461	12.50
45-5024	1.25	45-6290	*45-5009	45-6383	6.00	45-6464	12.50
45-5025	1.25	45-6292	*45-5009	45-6385	.13	45-6466	37.25
45-5026	1.25	45-6294	.50	45-6386	.30	45-6467	12.00
45-5027	1.25	45-6295	*54-7557	45-6386-1	.30	45-6468	13.50
45-5028	1.25	45-6295-1	*54-7557-1	45-6387	.02	45-6469	12.50
45-5029	1.25	45-6296	.30	45-6388	6.75	45-6470	50.00
45-5030	1.25	45-6297	.50	45-6389	2.50	45-6471	51.00
45-5031	1.25	45-6298	.20	45-6389-1	1.75	45-6472	41.00

* Recommended substitute.

ALL PRICES SUBJECT TO CHANGE WITHOUT NOTICE

RADIO PARTS PRICE LIST—Continued

PART NUMBER	LIST PRICE or Substitute	PART NUMBER	LIST PRICE or Substitute	PART NUMBER	LIST PRICE or Substitute	PART NUMBER	LIST PRICE or Substitute
45-6473	25.00	45-8795-12	13.20	45-9120-20	8.00	45-9531	.15
45-6474	15.00	45-8796-6	10.80	45-9123-20	8.00	45-9532	.50
45-6475	17.00	45-8797-6	9.90	45-9124-20	8.00		
45-6476	17.00	45-8805-3	35.70	45-9130-20	8.00	46-1764	*42-1764
45-6477	75.00	45-8806-6	23.70	45-9140-20	8.00		
45-6479	.35	45-8812-3	18.75	45-9141-20	8.00	47-7502	1.25
45-6480	1.75	45-8813-3	37.50	45-9142-20	8.00		
45-6481	1.00	45-8814-3	75.00	45-9143-20	8.00	52-0241	†
45-6482	23.00	45-8840-36	32.40	45-9144-20	8.00	52-2158	†
45-6483	9.00	45-8841-24	21.60	45-9145-20	8.00	52-2266	†
45-6484	9.50	45-8875-12	4.80	45-9170-20	8.00	52-2267	†
45-6485	2.00	45-8876-12	4.80	45-9180-20	8.00	52-2271	†
45-6488	8.00	45-8877-12	4.80	45-9185-20	8.00		
45-6489	15.00	45-8878-12	4.80	45-9186-12	3.80	54-4004	*27-4809
45-6490	10.00	45-8879-20	12.00	45-9190-12	4.80	54-4005	*27-4809
45-6491	10.00	45-8880-20	8.00	45-9191-12	4.80	54-4009	.15
45-6492	10.00	45-8882-20	8.00	45-9192-12	4.80	54-4012	*27-4820
45-6493	15.00	45-8885-20	8.00	45-9195-20	8.00	54-4015	.08
45-6494	6.75	45-8900-20	8.00	45-9200-20	8.00	54-4020	.02
45-6495	30.00	45-8902-20	8.00	45-9205-20	12.00	54-4023	*54-4105
45-7502	1.25	45-8903-20	8.00	45-9206-20	8.00	54-4025	.01
45-7502A	1.25	45-8904-20	8.00	45-9210-20	8.00	54-4027	.75
45-8501-12	6.60	45-8907-20	8.00	45-9215-20	8.00	54-4029	.60
45-8502-12	7.20	45-8909-20	8.00	45-9220-20	8.00	54-4030	*27-4767
45-8504-12	13.20	45-8912-20	8.00	45-9221-20	8.00	54-4034	*54-4048
45-8508-12	21.00	45-8920-20	8.00	45-9225-12	4.80	54-4038	3.00
45-8509-3	37.50	45-8921-20	8.00	45-9230-20	8.00	54-4040	.05
45-8511-12	6.60	45-8924-20	8.00	45-9235-20	8.00	54-4043	*27-4891
45-8512-12	7.20	45-8926-20	8.00	45-9240-20	8.00	54-4045	.08
45-8514-12	13.20	45-8928-20	8.00	45-9245-20	8.00	54-4048	.08
45-8522-12	7.20	45-8932-20	8.00	45-9250-12	4.80	54-4052	.20
45-8524-12	13.20	45-8940-20	8.00	45-9255-12	4.80	54-4053	*27-4891
45-8534-12	12.00	45-8942-20	8.00	45-9260-20	8.00	54-4064	.01
45-8572-12	6.00	45-8945-20	8.00	45-9263-20	8.00	54-4069	*27-4891
45-8574-12	7.80	45-8946-20	8.00	45-9265-20	8.00	54-4087	*27-4099-3
45-8578-12	10.80	45-8950-20	8.00	45-9270-20	8.00	54-4088	.35
45-8579-3	15.75	45-8955-20	8.00	45-9271-20	8.00	54-4089	.20
45-8584-12	5.40	45-8956-20	8.00	45-9275-20	8.00	54-4090	3.00
45-8602-12	6.00	45-8957-20	8.00	45-9280-20	8.00	54-4091	*54-4052
45-8604-12	9.00	45-8965-20	8.00	45-9281-20	8.00	54-4092	*54-4105
45-8608-12	12.00	45-8970-20	8.00	45-9282-20	8.00	54-4099	3.00
45-8609-12	21.60	45-8975-20	8.00	45-9283-20	8.00	54-4101	.20
45-8611-12	6.60	45-8978-20	8.00	45-9285-20	8.00	54-4102	*54-4115
45-8621-12	5.40	45-8979-20	8.00	45-9290-20	8.00	54-4104	3.00
45-8622-12	9.00	45-8980-20	8.00	45-9295-20	8.00	54-4105	.20
45-8670-3	1.80	45-8985-20	8.00	45-9505	2.25	54-4106	.15
45-8671-3	1.80	45-8990-20	8.00	45-9506	2.75	54-4111	*54-4144
45-8675-3	1.80	45-8995-20	8.00	45-9507	4.25	54-4114	.05
45-8680-3	9.00	45-9000-20	8.00	45-9508	2.25	54-4115	.20
45-8681-3	9.00	45-9001-20	8.00	45-9509	2.25	54-4118	.15
45-8685-3	9.00	45-9002-20	8.00	45-9510	2.25	54-4119	1.10
45-8690-6	9.90	45-9005-20	8.00	45-9511	2.50	54-4122	.03
45-8691-6	9.90	45-9010-20	8.00	45-9512	2.25	54-4126	*54-4106
45-8692-6	9.90	45-9012-20	8.00	45-9513	4.25	54-4127	.15
45-8693-6	9.90	45-9015-12	4.80	45-9514	3.33	54-4128	*16594
45-8694-6	9.90	45-9020-20	8.00	45-9515	3.90	54-4135	*54-4105
45-8695-6	9.90	45-9022-20	8.00	45-9516	1.20	54-4136	*54-4105
45-8696-6	9.90	45-9023-20	8.00	45-9519	4.50	54-4137	.20
45-8697-6	9.90	45-9025-20	8.00	45-9520	3.25	54-4142	*217-1057
45-8698-6	9.90	45-9030-20	8.00	45-9521	44.45	54-4143	*54-4105
45-8700-6	9.90	45-9040-20	8.00	45-9522-24	39.60	54-4144	.15
45-8701-6	9.90	45-9050-20	8.00	45-9523-14	.25	54-4145	7.50
45-8702-6	9.90	45-9055-20	8.00	45-9523-15	.25	54-4146-1	.40
45-8703-6	9.90	45-9060-20	8.00	45-9523-16	.25	54-4148	.35
45-8704-6	9.90	45-9070-20	8.00	45-9523-38	.25	54-4148-1	.80
45-8705-6	9.90	45-9071-20	8.00	45-9523-39	.25	54-4148-2	.45
45-8706-6	9.90	45-9074-20	8.00	45-9523-40	.25	54-4149	1.00
45-8708-6	9.90	45-9075-20	8.00	45-9523-46	.25	54-4150	.90
45-8718-6	3.30	45-9080-20	8.00	45-9523-51	.25	54-4152	1.85
45-8750-12	15.00	45-9081-20	8.00	45-9523-56	.25	54-4153	.02
45-8751-12	34.20	45-9083-12	4.80	45-9523-60	.25	54-4154	.20
45-8755-12	15.00	45-9090-20	8.00	45-9523-67	.25	54-4156	*16595
45-8756-12	54.00	45-9095-20	8.00	45-9523-68	.25	54-4168	.02
45-8760-12	15.00	45-9100-20	8.00	45-9524	60.00	54-4170	.15
45-8761-12	54.00	45-9105-20	8.00	45-9525	†	54-4176	.02
45-8775-12	7.20	45-9110-12	4.80	45-9526	†	54-4177	.25 C
45-8776-12	18.00	45-9111-12	4.80	45-9527	4.00	54-4180	*27-4326
45-8777-2	12.50	45-9112-12	4.80	45-9528	3.75	54-4181	1.00 C
45-8780-12	10.20	45-9115-20	8.00	45-9530	4.50	54-4194	*56-2027
45-8781-12	10.20	45-9117-20	8.00			54-4208	.08

* Recommended substitute.
† Refer to distributor.

ALL PRICES SUBJECT TO CHANGE WITHOUT NOTICE

RADIO PARTS PRICE LIST—Continued

PART NUMBER	LIST PRICE or Substitute	PART NUMBER	LIST PRICE or Substitute	PART NUMBER	LIST PRICE or Substitute	PART NUMBER	LIST PRICE or Substitute
54-4212	.45	54-4346	.10	54-4527-2	.35	54-4659-2	.30
54-4214	.45	54-4349-14	.05	54-4527-3	.35	54-4659-3	.30
54-4214-1	.25	54-4350	.20	54-4527-4	.35	54-4661	.25
54-4217	.50	54-4350-1	.15	54-4527-5	.35	54-4661-1	.40
54-4218	.23	54-4362	.02	54-4527-6	.35	54-4662	.25
54-4218-1	.40	54-4367	.08	54-4527-7	.35	54-4662-1	.25
54-4218-2	.30	54-4369	.20	54-4527-8	.45	54-4664	.25
54-4220	.05	54-4372	.03	54-4527-9	.45	54-4664-1	.30
54-4227	.35	54-4375	.25	54-4527-10	.50	54-4664-2	.25
54-4227-1	.40	54-4376	.18	54-4527-11	.65	54-4664-3	.30
54-4227-2	.20	54-4377	1.70 C	54-4527-12	.45	54-4665	.80
54-4227-3	.40	54-4390	.15	54-4527-13	.40	54-4667	.03
54-4227-4	.35	54-4401	.07	54-4527-14	.40	54-4670-1	.65
54-4227-5	.40	54-4406	.10	54-4527-15	.40	54-4673	.10
54-4228	.30	54-4407	7.00 C	54-4527-16	.40	54-4674	.50
54-4234	1.50	54-4408	.20	54-4527-17	.40	54-5001	.60
54-4235	.07	54-4426	.10	54-4527-18	.55	54-5003	.30
54-4236	.09	54-4426-2	.20	54-4527-19	.55	54-5004	.65
54-4237	.10	54-4426-3	.15	54-4527-20	.40	54-5005	.75
54-4239	.03	54-4431	.05	54-4531	.30	54-5007	.90
54-4240	.09	54-4431-1	.10	54-4532	.50	54-5008	1.50
54-4242	.35	54-4431-2	.08	54-4536	9.50	54-5008-1	.90
54-4245	.12	54-4432	4.80	54-4541	.30	54-5009	1.40
54-4248	.20	54-4437	.30	54-4542	.80	54-5009-1	54-5009
54-4248-2	.25	54-4437-1	*76-4333	54-4543	4.25	54-5010	.75
54-4249	.75	54-4438	.85	54-4544	4.25	54-5011	2.40
54-4250	1.25	54-4440	.20	54-4545	2.75	54-5012	3.00
54-4252	.20	54-4441	1.65	54-4551	1.65	54-5013	1.00
54-4253	.35	54-4442	1.00	54-4551-1	1.65	54-5015	*76-4167
54-4254	.08	54-4443	.55	54-4551-2	1.65	54-5018	.65
54-4255	.20	54-4444	.50	54-4551-3	1.65	54-5021	1.25
54-4256	.20	54-4445	.15	54-4557	.15	54-5022	.50
54-4257	.20	54-4447	.85	54-4557-1	.15	54-5024	1.60
54-4258	.45	54-4448	.65	54-4557-2	.15	54-5024-1	1.50
54-4262	3.75	54-4451	4.00	54-4557-3	.15	54-5025	2.15
54-4267	.03	54-4453	4.50	54-4562	.30	54-5026	.30
54-4272	.20	54-4457	1.60	54-4565	.75	54-5027	1.60
54-4273	56-4138FCP	54-4458	1.50	54-4567	.35	54-5029	.60
54-4274	.05	54-4460	.10	54-4567-1	.25	54-5031	2.50
54-4275	.03	54-4461	.10	54-4570	5.50	54-5033	1.00
54-4280	.02	54-4464	1.60	54-4578	2.25	54-5034	.50
54-4281	.40	54-4468	.20	54-4579	.05	54-5036	.75
54-4282	56-3177	54-4475	.05	54-4581	.30	54-5037	1.15
54-4288	4.50	54-4478	1.00	54-4581-1	.30	54-5040	1.70
54-4290	1.18 C	54-4479	.60	54-4585	.15	54-5041	1.50
54-4291	1.05 C	54-4479-1	.50	54-4592	.10	54-5042	1.75
54-4292	.15	54-4484	.45	54-4595	.85	54-5043	1.00
54-4292-1	.35	54-4485	.10	54-4596	1.00	54-5047	.80
54-4294	.04	54-4486	.20	54-4599	.25	54-5048	.85
54-4295	.024	54-4486-1	.30	54-4600	2.35	54-6001	3.75
54-4303	.15	54-4486-2	*54-4486	54-4602	.10	54-7044	.05
54-4304	.15	54-4486-3	.25	54-4604	10.00	54-7063	.15
54-4304-1	.20	54-4486-4	.25	54-4605	5.50	54-7078	.75
54-4311	.30	54-4486-5	.25	54-4605-1	6.50	54-7080	.80
54-4313	.022	54-4488	*54-4115	54-4606	5.50	54-7082	5.00 C
54-4313-1	.02	54-4488-1	.30	54-4607	1.30	54-7084	.05
54-4314-1	1.00 C	54-4488-2	.55	54-4608	.55	54-7089	.30
54-4317	.25 C	54-4488-3	.30	54-4609	.35	54-7090	.40
54-4317-1	.50 C	54-4491	.20	54-4610	.10	54-7091	.40
54-4317-2	.50 C	54-4495	.80	54-4617	.15	54-7092	.30
54-4317-3	.50 C	54-4502	.45	54-4624	.05	54-7093	.35
54-4317-4	.50 C	54-4502-1	.35	54-4625-1	8.50	54-7094	.40
54-4317-5	.50 C	54-4503	.75	54-4626-1	10.00	54-7096	.35
54-4317-6	.25 C	54-4504	.35	54-4627	.20	54-7097	.35
54-4317-7	.05	54-4505	6.50 C	54-4630	.75	54-7099	.05
54-4318	.25 C	54-4505-1	*54-4505	54-4634	.50	54-7100	.75
54-4319	.25 C	54-4506	2.25	54-4638	.50	54-7101	45-6239
54-4320	.25 C	54-4506-3	2.40	54-4638-1	.40	54-7105	.55
54-4321	.50 C	54-4510	.25	54-4642	*54-4642-1	54-7106	1.10
54-4323	.30	54-4511	.25	54-4642-1	.30	54-7107	3.00
54-4324	*27-4330	54-4517	.50	54-4643	*76-4315	54-7119	2.50 C
54-4329	.75	54-4520	1.75	54-4645	3.00 C	54-7123	.05
54-4334	.30	54-4521	7.50	54-4646	.20	54-7124	.15
54-4336	.04	54-4522	6.50	54-4647	.08	54-7127	.30
54-4338	.17	54-4523	1.10	54-4648	.15	54-7128	.35
54-4338-1	.20	54-4524	.05	54-4650	.05	54-7129	.05
54-4343	.08	54-4524-1	.01	54-4652	1.00	54-7130	.09
54-4343-1	.30	54-4525	6.50 C	54-4658	8.50	54-7135	.35
54-4344	*28-5609	54-4527	.45	54-4659	.25	54-7137	.08
54-4345	.13	54-4527-1	.35	54-4659-1	.30	54-7138	.05

* Recommended substitute.

ALL PRICES SUBJECT TO CHANGE WITHOUT NOTICE

RADIO PARTS PRICE LIST—Continued

PART NUMBER	LIST PRICE or Substitute	PART NUMBER	LIST PRICE or Substitute	PART NUMBER	LIST PRICE or Substitute	PART NUMBER	LIST PRICE or Substitute
54-7144	.08	54-7527	1.00	55-0195	*85-0052	55-1266	.20
54-7158	.23	54-7528	1.15	55-0234	.77-0250	55-1278	.20
54-7159	.25	54-7533	.08	55-0303	*27-6128	55-1318	.20
54-7169	1.75 C	54-7540	2.00	55-0332	.25	55-1319	.20
54-7183	.20	54-7540-1	2.10	55-0426	.35	55-1320	.20
54-7184	.35	54-7541	.25	55-0438	.30	55-1348-1	.85
54-7198	.10	54-7552	.75	55-0438-1	.20	55-1349	*77-0909
54-7200	.08	54-7552-1	3.25	55-0443	*55-1318	55-1350	.90
54-7209	.30	54-7553	.20	55-0449	.03	55-1351	.60
54-7210	.20	54-7555	1.40	55-0470	*27-4604	55-1353	.30
54-7215	.08	54-7557	1.75	55-0499	*27-4604	55-1354	.08
54-7236	.75	54-7557-1	1.75	55-0501	.15	55-1355	.15
54-7243	.25	54-7561	9.00	55-0547	*77-0654	55-1363	.20
54-7244	1.50	54-7570	*54-7596	55-0575	*27-6128	55-1364	.30
54-7245	1.00 C	54-7573	.20	55-0580	*77-0654	55-1366	.10
54-7263	15.00	54-7573-1	.35	55-0581	.45	55-1368	1.20
54-7272	28.00	54-7573-3	.15	55-0632	*77-0352	55-1369	.95
54-7274	70.00	54-7573-4	.15	55-0650	*55-0713	55-1370	.95
54-7277	.10	54-7577	7.50 C	55-0651	*77-0654	55-1371	.95
54-7278	.07	54-7588	.15	55-0683	*77-0654	55-1377	.10
54-7279	1.25	54-7593	.70	55-0695	.08	55-1384	*55-1428
54-7280	.05	54-7595	3.50	55-0700	.35	55-1387	*55-1318
54-7281	.80	54-7595-1	6.50	55-0713	.15	55-1388	.65
54-7290	3.25	54-7595-2	2.75	55-0743	.20	55-1389	.15
54-7291-1	.65	54-7595-3	5.75	55-0744	.20	55-1407	.02
54-7292	3.00	54-7596	2.95	55-0760	*77-0723	55-1410	1.10
54-7296	.04	54-7598	9.00	55-0775	*27-6128	55-1423	.35
54-7296-1	.50 C	54-7600	.08	55-0781	.20	55-1424	.30
54-7309	.30	54-7601	.06	55-0783	.15	55-1428	.30
54-7309-1	.30	54-7603	1.40	55-0890	3.00 C	55-1447	1.00
54-7309-2	.60	54-7606	.50	55-0926	.20	55-1448	.60
54-7309-3	.45	54-7608	2.50	55-0935	*45-1459	55-1452	.50
54-7309-4	.35	54-7609	13.00	55-0936	*55-0976	55-1453	*54-7184
54-7310	1.50 C	54-7612	.45	55-0937	.35	55-1462	*55-1490
54-7333	.08	54-7613	.10	55-0945	.20	55-1465	.95
54-7334	.08	54-7619	.25	55-0950	.35	55-1472	.20
54-7340	6.75	54-7619-1	.30	55-0957	.15	55-1482	1.50
54-7340-1	8.00	54-7620	.40	55-0974	*55-0976	55-1490	.15
54-7351	.08	54-7630	.30	55-0975	.20	55-1491	*55-1490
54-7370	.35	54-7638	2.25	55-0976	.35	55-1494	.50
54-7371	1.10	54-7639	.30	55-0977	*55-0976	55-1507	*54-7210
54-7371-1	1.85	54-7640	2.25	55-0978	*55-0976	55-1517	*55-1371
54-7371-2	*54-7371	54-7665	.25	55-0979	*55-0976	56-1050	.15
54-7378	10.00	54-7667	.05	55-0980	*55-0976	56-1104	4.00
54-7379	2.50	54-7668	3.00	55-0993	.45	56-1146	.10
54-7383-1	.15	54-7671	3.00	55-1012	.50	56-1146-1	.10
54-7393	.35	54-7676	.06	55-1034	.50	56-1183	.30
54-7395	1.25	54-7680	3.20	55-1045	.20	56-1198	.15
54-7397	.35	54-7682	.30	55-1054	.15	56-1222	*318-1608
54-7398	.50	54-7685	.15	55-1055	.10	56-1276	.30
54-7398-2	.75	54-7687	1.60	55-1057	.06	56-1307FA4	.05
54-7398-3	.65	54-7695	.35	55-1060	.20	56-1318	.20
54-7401	.45	54-7699-1	.10	55-1061	.25	56-1326	.15
54-7408	.08	54-7702	4.50	55-1067	*77-0654	56-1330	.15
54-7412	.65	54-7703	.60	55-1068	3.00 C	56-1333	.15
54-7416-1	1.25	54-7710	.04	55-1075	*55-1173	56-1346	.03
54-7419	.05	54-7711	2.50	55-1078	*55-1318	56-1376	.08
54-7420	.05	54-7711-1	2.60	55-1084	.15	56-1379	.08
54-7425	2.50 C	54-7713	2.50	55-1104	*55-1319	56-1387	.02
54-7433	.30	54-7717	3.25	55-1117	*55-1318	56-1452	.08
54-7453	.20	54-7733	.15	55-1118	*55-1318	56-1464	*56-1276
54-7456	3.75 C	54-7735	2.50	55-1122	.10	56-1466	.03
54-7460	4.50 C	54-7741	1.25	55-1124	*55-1111	56-1466FA5	*56-1466
54-7465	.50	54-7742	12.00	55-1125	*318-2376	56-1479	.15
54-7465-1	.40	54-7747	1.25	55-1137	*55-1111	56-1494	*27-4891
54-7483	5.25	54-7748	4.25	55-1140	1.85	56-1516	*56-2159
54-7483-1	4.25	54-7749	1.25	55-1141	.30	56-1517	.15
54-7486	1.25	54-7750	.50	55-1148	*55-0936	56-1525	.40
54-7492	.50	54-7755	.20	55-1159	.15	56-1566FA5	.10
54-7492-1	.30	54-7761	.10	55-1166	.20	56-1619	*28-4468
54-7494	*45-6406	54-7765	1.00	55-1169	*55-1300	56-1634	.04
54-7506	.30			55-1173	.50	56-1752	.20
54-7509	1.10	55-0011	.35	55-1174	*318-2376	56-1793	.35
54-7512	.15	55-0099	*55-0332	55-1181	.40	56-1795FA15	.10
54-7516	4.00	55-0102	*77-0654	55-1191	*27-4788	56-1795-1	.20
54-7518	.90	55-0117	*55-0068	55-1194	.90	56-1804FC33	.15
54-7523	.75	55-0129	*77-0250	55-1196	.75	56-1822	.20
54-7524	2.00	55-0165	.15	55-1197	*55-1194	56-1856	*56-2159
54-7525	.75	55-0167	*55-0165	55-1200	.50	56-1866	.01
54-7526	1.10	55-0180	*77-0252	55-1243	.75		

* Recommended substitute.

ALL PRICES SUBJECT TO CHANGE WITHOUT NOTICE

RADIO PARTS PRICE LIST—Continued

PART NUMBER	LIST PRICE or Substitute	PART NUMBER	LIST PRICE or Substitute	PART NUMBER	LIST PRICE or Substitute	PART NUMBER	LIST PRICE or Substitute
56-1877	.03	56-2619	3.00	56-3004	.05	56-3386	.12
56-1880	.05	56-2620	.80	56-3019	1.10	56-3386-1J39	.07
56-1882	.10	56-2621	1.25	56-3023	.25	56-3386FA54	.50
56-1883	3.00	56-2622	3.00	56-3043	.08	56-3408	1.10
56-1886	.15	56-2623	.60	56-3043FA15	.05	56-3410	.04
56-1888	.10	56-2626	.08	56-3049	15.00	56-3412	1.50
56-1958	.25	56-2627	.05	56-3051	22.00	56-3413	.06
56-2003	56-3023	56-2628	1.10	56-3054	.35	56-3414	.04
56-2027	.10	56-2652	.90	56-3056	.20	56-3532	.02
56-2057FA3	.30	56-2653	56-3540FJ9	56-3059	.10	56-3539FJ6	.60
56-2059FA3	.03	56-2654	.10	56-3066	.05	56-3540FJ9	1.75
56-2068	.08	56-2655	.10	56-3074	.05	56-3544	5.25
56-2071	.10	56-2656	.05	56-3084	.10	56-3545-3FA3	.10
56-2071-2	.05	56-2657	.30	56-3090	.08	56-3545-5	.08
56-2076FCP	56-2076-1	56-2671FA3	.03	56-3091	.15	56-3545-6	.08
56-2076-1	.20	56-2672FA3	.03	56-3092	.25	56-3548-1FA1	.32
56-2076-5	.15	56-2680	.45	56-3099	.15	56-3549	.06
56-2076-6	.20	56-2681FA3	.13	56-3103	.35	56-3550FA3	.50
56-2105FA3	7.50 C	56-2684	22.00	56-3106	.50	56-3550-1FA3	2.50
56-2109	.08	56-2692	20.00	56-3113	2.25	56-3575	.20
56-2133	.05	56-2694	.55	56-3117	.15	56-3583	.10
56-2134	.15	56-27001FA3	.05	56-3118	.08	56-3583-1	76-2470
56-2137FA15	.30	56-2710	.08	56-3119	.35	56-3583-3	.20
56-2151FA5	.02	56-2713	.45	56-3120	.05	56-3583-5	.20
56-2159	.20	56-2714	.06	56-3123FA3	.45	56-3583-4FCP	.20
56-2159FCP	56-2159	56-2726	1.50 C	56-3131	.40	56-3587	.10
56-2179	.15	56-2731	.08	56-3132	.10	56-3591	.15
56-2180	.20	56-2787	13.00	56-3135	56-3135FA3	56-3596	.15
56-2183	.35	56-2790	2.50	56-3135FA3	.25	56-3597	.15
56-2194FA3	.04	56-2792	.05	56-3138	.06	56-3600	.02
56-2215	.15	56-2793FA38	2.00 C	56-3147FA8	.08	56-3601	.30
56-2227	56-1517	56-2794	.35	56-3154FA3	.35	56-3602	.10
56-2228FCP	.20	56-2795	.05	56-3167	4.40 C	56-3606	.15
56-2233FCP	.75	56-2796	.05	56-3172	.35	56-3607	.20
56-2234	.06	56-2797	.05	56-3177	.20	56-3612-2	.45
56-2234-1	.12	56-2798	.07	56-3179	.30	56-3612-3	.15
56-2234-2	.05	56-2799	1.10	56-3179-2	.35	56-3612-4	.35
56-2234-3	.15	56-2799-1	1.50	56-3179-3	56-3179-2	56-3612-7	.40
56-2249	.03	56-2800	.02	56-3180-1	56-3180FC61	56-3616FA3	.10
56-2250	.03	56-2801	.02	56-3180FC61	1.50	56-3617	1.50
56-2261	.07	56-2802	2.25 C	56-3181-1	1.50	56-3618	.60
56-2289	56-2159	56-2803	.09	56-3181FC61	1.50	56-3619	1.25
56-2293	.15	56-2805	.05	56-3183	2.60	56-3620	.35
56-2316	.75	56-2806	.06	56-3185	.20	56-3621	2.25
56-2332	.06	56-2809	.20	56-3187	10.00	56-3623	1.25
56-2344	.08	56-2810	3.00 C	56-3193	.45	56-3624	2.50
56-2351-2	56-5241	56-2814	.50	56-3194	2.40	56-3627	2.50
56-2364	.15	56-2823	.02	56-3195	.60	56-3627-1	2.25
56-2366	3.50 C	56-2832FA3	3.00 C	56-3200	.09	56-3627-2	3.00
56-2408FE15	.20	56-2838	.05	56-3201	2.50	56-3627-6	2.35
56-2448	.20	56-2839	.05	56-3201-1FA3	2.25	56-3628FA3	.15
56-2530	28-4468	56-2844	.04	56-3202	.05	56-3629	.20
56-2540FCP	.30	56-2851	.08	56-3204	.02	56-3630	.12
56-2540FE27	56-2540FCP	56-2865	.05	56-3205	.02	56-3634	.04
56-2541-1	.20	56-2885	76-2252	56-3206	1.75 C	56-3645	.10
56-2546	.35	56-2886	.02	56-3208	.60	56-3646	.40
56-2546-1	.30	56-2891	.12	56-3221	.08	56-3647	.70
56-2546-2	.35	56-2896	.20	56-3225	1.10	56-3648	.35
56-2560	.75	56-2897	.50	56-3234	.20	56-3649	.50
56-2561	.30	56-2898	.12	56-3236FA1	.25	56-3650	.70
56-2562	.10	56-2907FA3	.50	56-3237	.50	56-3653	.45
56-2563	3.00 C	56-2915	.60	56-3240	.60	56-3654	.20
56-2564	4.00 C	56-2917	.18	56-3247	.20	56-3654-2	.15
56-2568	.20	56-2919FA8	2.85	56-3248	.04	56-3655	.20
56-2569	.08	56-2920	.05	56-3249	1.50	56-3656	.10
56-2570	.08	56-2927FE7	.01	56-3250	3.00	56-3657	.50
56-2573	.10	56-2928	.90	56-3271FA3	.60	56-3658	.35
56-2578	.20	56-2929	.05	56-3271FA11	.60	56-3659	.06
56-2583	1.50	56-2941	.06	56-3272FA5	56-3295	56-3675	.20
56-2584FE27	.09	56-2943	.12	56-3279	.05	56-3676	.08
56-2590	.05	56-2944	.14	56-3280-2FA3	4.00 C	56-3677	.15
56-2596	4.00 C	56-2945FA3	.18	56-3290	3.00 C	56-3681	.15
56-2597	.90	56-2957	.15	56-3295	.10	56-3683	.03
56-2598	.15	56-2965	.10	56-32951A15	.08	56-3683-1	.02
56-2599	1.25 C	56-2966	.35	56-3298	.40	56-3684	.20
56-2608FA3	.15	56-2976	2.75	56-3301FCP	.11	56-3687	.15
56-2609FA3	.30	56-2980	.10	56-3351	56-3351-1	56-3688	.08
56-2615	.08	56-2981	.10	56-3351	1.25	56-3690	.20
56-2617	.05	56-2996	.30	56-3358	.10	56-3694	.15
56-2618	1.35	56-2997	.12	56-3373	.15	56-3695	.12

* Recommended substitute.

ALL PRICES SUBJECT TO CHANGE WITHOUT NOTICE

RADIO PARTS PRICE LIST—Continued

PART NUMBER	LIST PRICE or Substitute	PART NUMBER	LIST PRICE or Substitute	PART NUMBER	LIST PRICE or Substitute	PART NUMBER	LIST PRICE or Substitute
56-3696	.02	56-4000	.15	56-4515	.35	56-4745	.04
56-3697	4.50	56-4005	.15	56-4519	1.85	56-4746FA8	.40
56-3698	.20	56-4006	.30	56-4520	.08	56-4747FA8	.40
56-3699	.20	56-4007	.30	56-4520-1	.10	56-4756	.08
56-3700	.35	56-4008	.30	56-4524	2.00	56-4762FA3	.10
56-3701	.30	56-4012-1	.12	56-4528FA3	.40	56-4767FA3	.30
56-3702	.30	56-4031FCP	.10	56-4535FCP	.45	56-4767-1FA3	.20
56-3703	.35	56-4032FCP	.10	56-4555	.10	56-4767-2FA3	.15
56-3704	.30	56-4033FA3	.04	56-4557FA3	1.20	56-4768FA3	.05
56-3705	.30	56-4033-FA3	.06	56-4560FA3	7.00 C	56-4770	3.00
56-3706	.20	56-4034	.06	56-4571	2.60	56-4774FA3	.10
56-3707	.08	56-4044	.60	56-4573	1.25	56-4778FA38	3.00 C
56-3707-1	.15	56-4045	.08	56-4574	.10	56-4787	.05
56-3708	.30	56-4056	.20	56-4577	.10	56-4788	.05
56-3709	.08	56-4055	.45	56-4580FCP	1.85	56-4790	.20
56-3709-1	.08	56-4059	1.40	56-4581FJ31	3.60	56-4796	56-4796-1
56-3710	.08	56-4066	.25	56-4582	1.50	56-4796-1	.90
56-3711	.15	56-4106	.05	56-4583FE7	.02	56-4796-2	.90
56-3713	.45	56-4109	2.50 C	56-4584FA3	2.50 C	56-4797FA3	1.00
56-3714	.08	56-4123	.10	56-4585FA3	8.00 C	56-4798-2	.25
56-3714-1	.08	56-4125FA3	.10	56-4587FA8	2.15	56-4810FA3	.50
56-3715	.08	56-4132FA15	1.25	56-4588FA3	.25	56-4812FA3	.15
56-3716	.30	56-4132-1FA15	1.50	56-4589FA3	3.50 C	56-4813	3.25
56-3720	.15	56-4138FCP	.20	56-4589-1FA11	.06	56-4818FA8	3.25
56-3721	.35	56-4139FE6	.20	56-4593	.30	56-4818-1FA8	3.25
56-3724	.50	56-4142FE6	.20	56-4594FA37	.35	56-4832FA1	.04
56-3730	.30	56-4145	.15	56-4595FA3	.05	56-4832-1FA1	.04
56-3731	.08	56-4151FA1	1.60 C	56-4596FA3	3.50 C	56-4846	.15
56-3737	.15	56-4282	.12	56-4597FA3	.15	56-4850	.15
56-3739	2.50	56-4298	21.00	56-4599FA3	.15	56-4860	.04
56-3740	4.50 C	56-4344FA3	.20	56-4600FA38	7.00 C	56-4862FA8	3.25
56-3741	.05	56-4346	.35	56-4601	.08	56-4862-1FA8	3.00
56-3753	.05	56-4346-1	.35	56-4601-1	.08	56-4863FA3	.15
56-3754	.20	56-4350FA3	.25	56-4601-2	.05	56-4867	54-4517
56-3755	.05	56-4353FA1	.05	56-4601-3	.05	56-4870FA3	.30
56-3756	.03	56-4357	.20	56-4603FA38	.05	56-4873	1.70
56-3757	.02	56-4362-1FCP	.15	56-4604FE15	.05	56-4878	3.00
56-3758	.15	56-4362FCP	.15	56-4606FA3	2.50 C	56-4882	.50
56-3759	.15	56-4362-3	.15	56-4607FA3	.05	56-4882-1	56-4882
56-3761	.15	56-4362-4	.15	56-4608FA38	6.00 C	56-4885	.50
56-3761-1	.15	56-4362-2FCP	56-4362-3	56-4610FA38	.05	56-4886FA22	.15
56-3763	.10	56-4363-1FA8	3.00	56-4612	54-7613	56-4888	.50
56-3769	.03	56-4365FA3	.50	56-4613FA38	2.25 C	56-4889	.50
56-3770	.08	56-4403FA30	1.10	56-4614	2.25 C	56-4891	2.00
56-3771	.02	56-4407	.15	56-4615	.35	56-4898	.10
56-3772	.02	56-4413FA3	.65	56-4616FE15	.20	56-4903FA8	2.30
56-3794	.15	56-4414-1FA1	3.00 C	56-4617FA3	.30	56-4903-1FA8	2.25
56-3807-3	3.00 C	56-4414FA1	3.00 C	56-4618FE15	.75	56-4914FA3	.15
56-3832	.25	56-4415-1FA8	3.50	56-4626-1FA7	.40	56-4915	1.50
56-3833	.25	56-4415FA8	2.75	56-4627FA3	7.00 C	56-4916	.10
56-3837	.75	56-4416FA8	2.10	56-4628FA38	2.00 C	56-4918	.04
56-3841	.10	56-4416-1FA8	2.00	56-4629	.55	56-4919	.10
56-3846	.10	56-4420	2.00	56-4630FA38	.05	56-4920	6.00
56-3857FA3	.12	56-4420-1	2.50	56-4631FE15	.05	56-4921FJ31	1.85
56-3864	.08	56-4420-2	2.00	56-4633	.15	56-4925	1.10
56-3867	.55	56-4421FJ21	1.25	56-4635FCP	1.25	56-4925-1	1.10
56-3874FA33	.75	56-4421FJ22	1.35	56-4636	1.75	56-4925-3	1.10
56-3877FA38	.18	56-4421-3J21	1.75	56-4638	.50	56-4925-4FCP	1.10
56-3888	.25	56-4423	.85	56-4670FA38	.05	56-4925-5FCP	1.10
56-3889	.30	56-4439	56-5256	56-4679	.20	56-4926	.05
56-3901	1.60	56-4441	10.00 C	56-4680	.10	56-4932	.80
56-3910	.30	56-4443	2.00	56-4682-1	4.00 C	56-4934	.50
56-3915	.10	56-4452	2.25	56-4682FA1	4.00 C	56-4954FCP	.75
56-3918	.08	56-4455	.50	56-4693FA8	3.00	56-4954-1FCP	1.00
56-3919	.50	56-4456FA1	3.50 C	56-4694FA8	1.25	56-4957FJ12	.60
56-3920	.20	56-4456-1FA1	.05	56-4696FJ41	1.35	56-4960	.10
56-3925	.10	56-4456-2FA1	3.50 C	56-4711-1FA1	.20	56-4961	.02
56-3927	1.10	56-4457FA3	.50	56-4711FA1	.20	56-4978	.20
56-3928	1.25	56-4459	.20	56-4714FA8	3.75	56-4978-1	.15
56-3938	.15	56-4459-1FA8	4.00	56-4714-1FA8	3.25	56-4979FA15	.20
56-3939-1FA3	1.00	56-4459-2FA8	3.00	56-4716FE26	.45	56-4980	.35
56-3953FA1	.10	56-4466FA1	.05	56-4724	3.60 C	56-4981	8.00
56-3954	.50	56-4466-1FA1	.05	56-4727FA8	.45	56-4985	5.25
56-3961	.10	56-4467FA3	6.50 C	56-4729FA8	.60	56-4989	.15
56-3972	1.20	56-4468FA3	.30	56-4730FA8	3.25	56-4992	.20
56-3973	28.00	56-4469FA8	3.25	56-4730-1FA8	3.00	56-4997FA3	.05
56-3978FA3	.10	56-4469-1FA8	3.00	56-4732FA3	.20	56-4998	.75
56-3978-1FA3	.10	56-4471	3.50	56-4733	.30	56-4999	.80
56-3979FA5	.20	56-4472	2.25	56-4734	.20	56-5000	1.10
56-3979-1FA5	.30	56-4500	.04	56-4735FA8	27-4687-6	56-5001	1.60

* Recommended substitute.

ALL PRICES SUBJECT TO CHANGE WITHOUT NOTICE

RADIO PARTS PRICE LIST—Continued

PART NUMBER	LIST PRICE or Substitute	PART NUMBER	LIST PRICE or Substitute	PART NUMBER	LIST PRICE or Substitute	PART NUMBER	LIST PRICE or Substitute
56-5011	.15	56-5581-4FA3	.25	56-5855-1	2.50	56-6480FA3	2.15
56-5017FA3	.15	56-5581-5FA3	.25	56-5857FE7	.20	56-6484	4.00
56-5018	.08	56-5581-6FA3	.25	56-5859-1FA8	3.75	56-6484-1	4.00
56-5020FA38	.15	56-5581-7FA3	.25	56-5859FA8	3.75	56-6491	.25
56-5027FA38	.10	56-5581-8FA3	.25	56-5860FCP	2.50	56-6493	1.50
56-5028FA9	2.00C	56-5581-9FA3	.25	56-5862	2.75C	56-6495	.20
56-5029	1.25	56-5581-10FA3	.20	56-5882	.40	56-6500FA3	.45
56-5031FE11	.15	56-5581-11FA3	.25	56-5886	1.75	56-6513	.20
56-5037FA38	.15	56-5581-12FA3	.25	56-5890	.35	56-6535	2.25
56-5043	.50	56-5593FCP	.35	56-5903	.10	56-6536	.30
56-5044	.20	56-5607FE15	.08	56-5912FA3	1.75C	56-6566	*21-8145
56-5045	.35	56-5629FA3	.15	56-5916	.15	56-6567	1.25
56-5046	.20	56-5630	.20	56-5931	2.40	56-6569	.25
56-5047	.20	56-5630-1FCP	.20	56-5954FA9	.15	56-6585	1.10
56-5048	.35	56-5630-2FCP	.25	56-5956	*56-6639	56-6586	.60
56-5049	.50	56-5630-2	.25	56-5975	.35	56-6596	2.00
56-5050	.40	56-5630-3FCP	.15	56-5981	.15	56-6596-1	2.25
56-5051FA22	.15	56-5630-4	.25	56-5984FJ6	2.25	56-6603	.35
56-5052FA22	.15	56-5630-5	.15	56-5985	.15	56-6604	.90
56-5053FA22	.15	56-5630-6	*56-5630-2FCP	56-5986	7.50C	56-6618	.10
56-5054	2.35	56-5630-6FCP	.15	56-5987	1.60	56-6639	.75
56-5054-1	1.60	56-5630-7FCP	.15	56-5987-1	1.35	56-6640	.20
56-5089	.60	56-5630-8	.15	56-5990	8.50C	56-6681FCP	.40
56-5090-1	.20	56-5630-11	.20	56-5991	7.00C	56-6684FCP	.20
56-5090-3	.15	56-5632FA3	2.00	56-5992	1.00	56-6685FA8	1.25
56-5093	1.50	56-5633	2.25	56-5995	.10	56-6687FE11	.025
56-5115	.15	56-5634	9.00	56-6033	.35	56-6693FA3	.15
56-5124	.30	56-5634FJ53	5.75	56-6052	.15	56-6712FA8	.50
56-5130FJ21	*76-3629FJ21	56-5639FA3	.20	56-6084	.05	56-6723	.40
56-5171-3FJ31	.75	56-5643	.45	56-6084FA3	2.50C	56-6794	.75C
56-5171-5FJ31	.75	56-5643-1	.50	56-6100	.20	56-6795	.75C
56-5236	4.50	56-5644	.05	56-6110	.35	56-6976	.15
56-5237	*56-5848	56-5653FA3	.20	56-6129	.20	56-6846FA8	.05
56-5239	1.75	56-5665	.10	56-6130	.20	56-6999	7.00
56-5241	.02	56-5673	.50	56-6152	*56-6193FCP		
56-5252FCP	*56-5630	56-5686	.08	56-6161	.06	57-0206	.20
56-5256	1.00	56-5688FA11	.15	56-6174	.20	57-0215	3.00
56-5272	2.25	56-5690FA3	*76-4353	56-6178	1.10	57-0308	.01
56-5272-1	1.70	56-5694	1.60	56-6179	.15	57-0327	.15
56-5278	.40	56-5698FA3	.05	56-6189FA5	.08	57-0364	*85-0020
56-5278-1	.30	56-5702FA3	.15	56-6190FA3	8.60C	57-0405	*57-0548
56-5282-1	.60	56-5713	.40	56-6190-1FA3	.07	57-0425	1.35
56-5282-4	.45	56-5713-1	.40	56-6192FA3	.20	57-0531	*57-0590
56-5287	3.50	56-5713-2	.20	56-6193FCP	.50	57-0590	.15
56-5313FJ21	*76-3958FJ21	56-5713-3	.20	56-6195	.50	57-0590-1	.30
56-5332	.20	56-5713-4	.40	56-6196	*31-2589	57-0590-1FA3	.30
56-5333	.05	56-5713-5	.40	56-6199FA33	.15	57-0591FA3	*57-0590-1FA3
56-5334	.15	56-5713-6	.20	56-6201	.15	57-0608	*57-0548
56-5335	.08	56-5713-7	.20	56-6202	.75	57-0617FA1	.05
56-5338	25.00	56-5713-8	.40	56-6243	.08	57-0651	.35
56-5339	1.15	56-5713-9	.25	56-6253	.10	57-0701	.06
56-5341FA45	4.50	56-5717	.75	56-6276	2.50C	57-0772	.50
56-5367	3.25	56-5728	4.00	56-6294	.20	57-0773	.50
56-5398	3.00	56-5735FA3	.20	56-6295	1.00	57-0794	.15
56-5398-1	1.50	56-5739FCP	.15	56-6296	.05	57-0802	.10
56-5406	.05	56-5739-1FCP	.15	56-6299	.08	57-0812FJ22	.50
56-5435FA3	.10	56-5740	.05	56-6305	.30	57-0812FC59	.20
56-5437	1.50	56-5742	5.50C	56-6307	7.50C	57-0829	*77-0474
56-5457	2.00C	56-5743	.10	56-6307-1FA3	.10	57-0892	.08
56-5461FA15	6.50C	56-5744	.85	56-6309	.55	57-0894	.15
56-5464	.65	56-5746	1.50	56-6309-1	.60	57-0923	.20
56-5465	4.00C	56-5754	.10	56-6309-4	.60	57-0924	*57-1096FA17
56-5466	3.00C	56-5755	.45	56-6318FA3	3.50C	57-0985	.05
56-5467FA3	7.00C	56-5758	2.50	56-6331FA3	.10	57-0992-1FA1	.05
56-5468FA3	.10	56-5760	.12	56-6332	6.00	57-0996	.20
56-5469FA3	.30	56-5763	1.50	56-6332-1	6.00	57-1002	.20
56-5476FA9	.15	56-5764	.50	56-6340FA3	3.00C	57-1030FA3	2.50C
56-5488	7.00C	56-5765	.15	56-6357FCP	.85	57-1038	*57-1096
56-5491FA30	.45	56-5765-1	.35	56-6365	2.35	57-1042FA3	.10
56-5510FA1	1.00	56-5769	1.10	56-6370	4.00	57-1043FA17	*57-1043FA32
56-5521	4.25	56-5769-1	1.10	56-6375	3.50	57-1043FA32	.35
56-5522	.50	56-5827FA3	.25	56-6376	.80	57-1096FA17	.15
56-5522-1	.30	56-5834FA3	.25	56-6392FA3	.15	57-1110FA7	.35
56-5523	.95	56-5835	7.00	56-6404	.20	57-1121	.08
56-5527	.75	56-5844	1.50	56-6408	.60	57-1135	.30
56-5558	2.50C	56-5846	.15	56-6419	.90	57-1137FA8	.15
56-5575FA15	1.10	56-5847	5.25	56-6420-1FCP	4.50C	57-1147	*77-0459
56-5581-2	.25	56-5848	6.00	56-6432	.25	57-1178	.05
56-5581-3	.25	56-5854	*56-5862	56-6434	.30	57-1225	*57-1425
56-5581-1FA3	.25	56-5855FCP	2.75	56-6476	1.00	57-1243FA3	.15

* Recommended substitute.

ALL PRICES SUBJECT TO CHANGE WITHOUT NOTICE

RADIO PARTS PRICE LIST—Continued

PART NUMBER	LIST PRICE or Substitute	PART NUMBER	LIST PRICE or Substitute	PART NUMBER	LIST PRICE or Substitute	PART NUMBER	LIST PRICE or Substitute
57-1324FA3	.35	57-1708	.04	57-2325	.20	60-010137	*60-00105407
57-1335	.04	57-1712FA3	.40	57-2333	.10	60-010157	*60-00105407
57-1340FA3	.15	57-1715	.02	57-2334	.35	60-010327	*60-00105407
57-1345FJ20	2.40	57-1731	.20	57-2342FA3	.30	60-010417	*60-00105407
57-1345FJ21	2.40	57-1744FA3	.30	57-2343FA3	.25	60-011327	*60-00105407
57-1348FC59	.35	57-1747	.02	57-2344	.20	60-01155237	*30-1220-26
57-1358	*57-1358FJ21	57-1769	.03	57-2344.1	.20	60-012327	*60-00105407
57-1358FJ21	2.25	57-1772FA3	.03	57-2358FA8	.10	60-01255237	*30-1220-27
57-1362	2.00 C	57-1774	.15	57-2379	.35	60-01455237	*30-1220-28
57-1363	.15	57-1780FA8	.35	57-2398	.35	60-015137	*60-00155407
57-1380FA3	.15	57-1782FA8	1.85	57-2399	1.85	60-015327	*60-00155407
57-1381	.08	57-1784FJ40	3.50	57-2401FA38	.02	60-015328	*60-00155407
57-1384	1.50	57-1787FA3	.60	57-2415FC59	1.50	60-01555237	*30-1220-29
57-1384-1	2.10	57-1792-1FA3	.35	57-2467FA8	.50	60-018312	*60-00205307
57-1385	1.35	57-1794FCP	.15	57-2468	.12	60-018317	*60-00205307
57-1386	1.25	57-1802	*57-0802	57-2469	.03	60-01855237	*30-1220-30
57-1386-1	1.60	57-1804	2.15	57-2472FA8	.50	60-020127	*60-00205307
57-1387FA3	.05	57-1805	1.90	57-2476FA8	2.60	60-020137	*60-00205307
57-1398FA3	.03	57-1806	2.00	57-2496	.90	60-020327	*60-00205307
57-1399FA3	.12	57-1838	.80	57-2533	.08	60-023137	*60-00245307
57-1403FA3	.15	57-1839	.20	57-2535	*56-3656	60-023317	*60-00245307
57-1404FA3	.10	57-1840FA3	.02	57-2563	.15	60-02355237	*30-1220-31
57-1413FA3	2.00	57-1841FE7	.20	57-2604	1.50	60-025137	*60-00245307
57-1421	.15	57-1844	.08	57-2608	.75	60-025157	*60-00245307
57-1422FA8	.08	57-1845	.15	57-2628	.02	60-025227	*60-00245307
57-1425FA3	.08	57-1847FE11	.02	57-2630	.15	60-030127	*60-00305307
57-1461FA3	.30	57-1849FA8	.30	57-2633	.35	60-030337	*60-00305307
57-1463	.03	57-1868FA11	.05	57-2646FA1	.15	60-030137	*60-00305307
57-1468FA3	.08	57-1870FA3	.02	57-2649	1.75	60-031257	*60-00305307
57-1487FA3	.30	57-1885FCP	.25	57-2671FA3	.10	60-035157	*60-00365307
57-1538	.03	57-1888FCP	.20	57-2679	.20	60-035257	*60-00365307
57-1540	.20	57-1889FCP	.15	57-2680	.03	60-04245237	*30-1220-32
57-1541	.35	57-1937	.03	57-2684	.06	60-04475237	*30-1220-33
57-1542	.35	57-1940FCP	.10	57-2707	.30	60-050327	*60-00515307
57-1547FC51	2.25	57-1942FJ20	6.00	57-2708	.08	60-050328	*60-00515307
57-1547FC59	1.80	57-1943FJ20	4.50	57-2709	.30	60-060137	*60-00625307
57-1548FC51	1.85	57-1949	.30	57-2727	.15	60-065157	*60-00625307
57-1550FA8	3.25	57-1958	.50	57-2744FCP	*57-2188FA8	60-070357	*60-00685407
57-1557FA3	.30	57-1967FA8	.75	57-2747FCP	.30	60-073157	*60-00685407
57-1559FA8	.35	57-1993FC52	3.25	57-2748	*57-2292	60-075157	*60-00685407
57-1560FA3	.15	57-1994FA3	.10	57-2749	*57-2220	60-075357	*60-00685407
57-1569	1.60	57-2018	.75	57-2754	*57-2248	60-080327	*60-00825307
57-1582FA8	1.85	57-2069	.30	57-2759	.06	60-080327	*60-00825307
57-1589FA8	.50	57-2134	*77-0842	57-2762	.08	60-10105007	*60-10105407
57-1608	.10	57-2135	*77-084	57-2763	*57-2399	60-10135017	*60-10105407
57-1609	.05	57-2140	.04	57-2783	.08	60-10105307	*60-10105407
57-1611	.15	57-2162FA3	.50	57-2813	1.00	60-10105407	.20
57-1623FA3	.30	57-2174FCP	.45			60-10105417	.20
57-1628FA3	.03	57-2176FA3	.15	60-00085407	*60-00105407	60-10125237	.35
57-1637FA3	.10	57-2178FC64	2.60	60-00105017	*60-00105407	60-10135237	.35
57-1639FA3	.03	57-2185FJ39	1.15	60-00105307	*60-00105407	60-10135307	.20
57-1640FA3	.08	57-2185FC64	2.50	60-00105407	.35	60-10155007	*60-10155407
57-1648FE11	.06	57-2186FA3	1.75	60-00155407	.20	60-10155017	*60-10155407
57-1649	.08	57-2186FJ39	1.30	60-00185307	.25	60-10155317	*60-10155407
57-1650	.25	57-2186FC64	1.85	60-00185317	.20	60-10155407	.20
57-1651	.08	57-2188FA8	2.00	60-00205307	.20	60-10195237	.35
57-1651-1	.15	57-2193FA3	.08	60-00225327	*30-1223-4	60-10205237	.35
57-1653	.05	57-2194FA3	.15	60-00245307	.20	60-10205307	.20
57-1659	.20	57-2202FE7	.05	60-00255407	*60-00245307	60-10215237	.35
57-1669	2.50 C	57-2208FA3	.05	60-00305307	.20	60-10245007	*60-10245307
57-1672FA3	.08	57-2211	1.50	60-00365307	.20	60-10245017	*60-10245307
57-1673FA3	.03	57-2211-1FJ39	2.00	60-00395407	.20	60-10245307	.25
57-1678FA8	*56-3386	57-2211FCF70	*57-2211	60-004517	*60-90505007	60-10255007	*60-10245307
57-1679FA3	.35	57-2211-1FC64	*57-2211	60-00505007	*60-00515307	60-10255017	*60-10245307
57-1680FA3	.05	57-2216FA8	1.00	60-00505407	*60-00515307	60-10255237	.35
57-1681	.08	57-2216FA54	1.25	60-00515237	.35	60-10255317	*60-10245307
57-1682FA8	.40	57-2217FA3	.20	60-00515307	.30	60-10255407	*60-10245307
57-1682FA54	.30	57-2218FE11	.03	60-005157	*60-90505007	60-10275407	.20
57-1683FA7	.35	57-2220FA8	2.00	60-005357	*60-90505007	60-10305307	.25
57-1683FA8	.45	57-2223	.05	60-00605007	*60-00625307	60-10335407	.25
57-1683FA54	.34	57-2225FA1	.08	60-00605237	.35	60-10355237	.45
57-1684	1.00 C	57-2238	*57-0617	60-006177	*60-90505007	60-10395407	.25
57-1692FC64	.08	57-2241	1.80	60-00625307	.20	60-10405237	.45
57-1693	.15	57-2248FA8	2.60	60-00625407	*60-00625307	60-10475007	*60-10515307
57-1700	.05	57-2249	.20	60-006377	*60-90505007	60-10475417	.25
57-1701FA3	.08	57-2253FCP	.15	60-00685237	.35	60-10505007	*60-10515307
57-1702	.35	57-2255	.90	60-00685407	.20	60-10505017	*60-10515307
57-1703	.30	57-2286FC40	.35	60-00825237	.35	60-10515307	.35
57-1705FA1	.10	57-2288	.04	60-00825307	.30	60-10565307	.30
57-1706	.03	57-2292	1.50	60-00915237	.35	60-10565314	.30

* Recommended substitute.

ALL PRICES SUBJECT TO CHANGE WITHOUT NOTICE

RADIO PARTS PRICE LIST—Continued

PART NUMBER	LIST PRICE or Substitute	PART NUMBER	LIST PRICE or Substitute	PART NUMBER	LIST PRICE or Substitute	PART NUMBER	LIST PRICE or Substitute
60-10625301	.35	61-0009	*45-3500-7	61-0121	*45-3500-1	63-0063	.35
60-10685237	.60	61-0010	*30-1220-8	61-0122	.25	63-0064	.60
60-10685401	.25	61-0011	.50	61-0123	*61-0130	63-0069	.40
60-10735304	*60-10755301	61-0013	1.85	61-0124	.50	63-0070	*63-0054
60-10753017	*60-10755301	61-0014	*61-0120	61-0125	.35	63-0071	2.00
60-10755007	*60-10755301	61-0015	*61-0113	61-0126	.55	63-0076	.45
60-10755071	*60-10755301	61-0016	1.85	61-0127	.55	63-0077	6.00
60-10755301	.35	61-0017	2.00	61-0128	*61-0179	63-0079	.45
60-10755407	*60-10755301	61-0019	2.00	61-0129	.50	63-0080	.45
60-10805004	*60-10825401	61-0022	*45-3005-8	61-0130	.55	63-0081	*63-0055
60-10825401	.25	61-0023	*61-0113	61-0132	*61-0120	63-0082	.35
60-10915301	.35	61-0026	*60-10215237	61-0133	.55		
60-110127	*60-10105407	61-0027	*30-1220-17	61-0134	*61-0137	65-0002	*45-6365
60-110157	*60-10105407	61-0030	*61-0138	61-0137	.50	65-0003	*45-6365
60-110327	*60-10105407	61-0031	*60-10405237	61-0138	.50	65-0004	*2-65-0013
60-110547	*60-10105407	61-0033	*60-10245307	61-0140	*60-00515237	65-0005	*2-65-0014
60-111127	*60-10105407	61-0034	*60-10245307	61-0141	*60-10205237	65-0006	*2-65-0015
60-111237	*60-10105407	61-0035	*61-0133	61-0142	*60-00685237	65-0007	*45-7502A
60-111457	*60-10105407	61-0036	*61-0125	61-0143	*60-20205304	65-0008	2.60
60-113117	*60-10135307	61-0037	.75	61-0144	*30-1220-23	65-0009	1.85
60-113328	*60-10135307	61-0038	*60-00155407	61-0146	*60-00685237	65-0013	.75
60-113337	*60-10135307	61-0039	*60-00205307	61-0148	*30-1220-4	65-0014	.75
60-115127	*60-10155407	61-0040	1.00	61-0149	.30	65-0015	.75
60-115137	*60-10155407	61-0043	*30-1220-8	61-0150	3.05	65-0016	7.00
60-115327	*60-10155407	61-0044	*60-10205307	61-0150A	3.05	65-0021	2.60
60-118151	*60-10205307	61-0047	*30-1220-33	61-0151	*61-0125	65-0022	*32-7036
60-120327	*60-10205307	61-0048	*60-00155407	61-0152	.25	65-0024	3.50
60-120328	*60-10205307	61-0052	*61-0153	61-0153	.55	65-0026	*65-0101
60-125127	*60-10245307	61-0053	*61-0122	61-0154	*61-0108	65-0031	*45-7502A
60-125157	*60-10245307	61-0054	*61-0137	61-0155	*45-3500-7	65-0033	*65-0016
60-125457	*60-10245307	61-0055	*60-10105407	61-0156	.80	65-0034	.50
60-130127	*60-10305307	61-0056	*61-0125	61-0157	*30-1220-21	65-0035	1.50
60-130327	*60-10305307	61-0059	*61-0115	61-0159	*30-1223-1	65-0037	.25
60-135127	*60-10335407	61-0061	45-3500-1	61-0163	.90	65-0038	*65-0015
60-135328	*60-10335407	61-0062	.25	61-0164	*45-3002	65-0039	IEA65-0014 IEA65-0015
60-140127	*60-10395407	61-0063	*61-0017	61-0166	*30-1220-26	65-0041	*45-6365
60-140327	*60-10395407	61-0064	*45-3500-1	61-0167	*30-1220-5	65-0043	*45-6365
60-141137	*60-10395407	61-0065	*60-00105407	61-0168	.80	65-0044	*45-6365
60-150127	*60-10515307	61-0066	*30-1220-32	61-0169	*61-0120	65-0045	*45-6365
60-177328	*60-10755301	61-0067	*30-1220-32	61-0170	.30	65-0046	7.00
60-20103017	*60-20105401	61-0068	1.80	61-0171	*61-0170	65-0047	1.50
60-20105017	*60-20105401	61-0068A	1.80	61-0173	.80	65-0048	1.00
60-20105231	.50	61-0071	*30-1220-22	61-0174	.30		
60-20105401	.30	61-0072	*61-0150	61-0176	*61-0120	65-0050	IEA65-0055 IEA65-0056
60-20125404	.30	61-0073	*61-0129	61-0177	.80	65-0052	*45-7502A
60-20135214	.60	61-0074	*61-0130	61-0178	.50	65-0053	1.00
60-20155404	.35	61-0076	*61-0089	61-0179	.25	65-0055	.75
60-20205004	*60-20205304	61-0077	*61-0108	61-0180	.25	65-0056	.75
60-20205304	.35	61-0078	*61-0109	61-0181	.80	65-0058	*45-7502A
60-20245304	.40	61-0079	*60-10105237	61-0182	.80	65-0071	*65-0162
60-20275404	.40	61-0080	*61-0090	61-0186	1.00	65-0072	*65-0404
60-20305004	*60-20305304	61-0082	*30-1220-32	62-010009001	.25	65-0073	*32-8182
60-20305304	.45	61-0083	*61-0137	62-010409001	.25	65-0074	*65-0120
60-20335404	.45	61-0084	*61-0137	62-015200001	.55	65-0075	*65-0433
60-20355224	*60-20335404	61-0086	*61-0089	62-022009001	.25	65-0077	1.00
60-20355304	*60-20335404	61-0087	.90	62-051009001	.40	65-0079	2.25
60-20395404	.50	61-0089	2.40	62-051209021	*30-1224-2	65-0082	*45-6365
60-20515304	.70	61-0089A	2.40	62-056409001	.30	65-0083	1.85
60-20535304	*60-20515304	61-0090	.45	62-110009001	.25	65-0084	*65-0052
60-20625304	.90	61-0100	*61-0120	62-122001001	.25	65-0085	2.25
60-20823404	.90	61-0101	*61-0122	62-133001001	.35	65-0088	*45-6389-2
60-210137	*60-20105401	61-0102	*61-0125	62-147001001	.35	65-0089	*45-6389-2
60-225234	*60-20245304	61-0103	*45-3500-7	62-168001001	.30	65-0090	*45-7502A
60-230124	*60-20305304	61-0104	*61-0113	62-215001011	.30	65-0095	7.00
60-230334	*60-20305304	61-0105	.50	62-215009001	*62-215001011	65-0097	4.00
60-235414	*60-20335404	61-0106	*61-0137	62-268001013	.70	65-0100	2.00
60-240124	*60-20395404	61-0107	*61-0137	62-980409001	.30	65-0101	2.25
60-250154	*60-20515304	61-0108	.25	63-0017	.50	65-0102	.15
60-250224	*60-20515304	61-0109	.25	63-0028	3.35	65-0104	*65-0015
60-250324	*60-20515304	61-0110	*61-0120	63-0030	.65	65-0114	1.80
60-253124	*60-20515304	61-0111	*61-0122	63-0035-4	.40	65-0118	2.75
60-253324	*60-20515304	61-0112	*61-0125	63-0035-6	.75	65-0120	.75
60-30103404	.115	61-0113	.30	63-0035-7	1.00	65-0121	2.50
60-310327	*60-30103404	61-0114	*61-0120	63-0047	*63-0077	65-0124	.75
60-90505007	.20	61-0115	.55	63-0048	.70	65-0134	*45-7502A
61-0002	*60-10685401	61-0116	*61-0108	63-0052	.25	65-0136	*45-6389-2
61-0003	*30-1220-10	61-0117	.50	63-0053	*31-6472	65-0137	*45-7502A
61-0004	*61-0011	61-0118	.50	63-0054	.35	65-0138	*45-7502A
61-0007	*60-00105407	61-0119	.30	63-0055	.35	65-0139	*45-7502A
61-0008	1.25	61-0120	.25	63-0056	.35		

* Recommended substitute.

ALL PRICES SUBJECT TO CHANGE WITHOUT NOTICE

RADIO PARTS PRICE LIST—Continued

PART NUMBER	LIST PRICE or Substitute	PART NUMBER	LIST PRICE or Substitute	PART NUMBER	LIST PRICE or Substitute	PART NUMBER	LIST PRICE or Substitute
65-0147	*65-0162	65-0319	2.15	65-0443-4	1.35	66-0563340	.12
65-0148	*45-6365	65-0320	*45-6365	65-0443-5	1.50	66-0564340	.15
65-0149	2.00	65-0321	2.50	65-0443-6	.90	66-0564360	.17
65-0150	1.75	65-0323	1.50	65-0443-7	1.25	66-0565340	.25
65-0151	.30	65-0324	*65-0229	65-0443-8	1.50	66-0681340	.12
65-0152	*65-0404	65-0337	.30	65-0443-9	.90	66-0683240	*66-0683340
65-0155	2.25	65-0338	*45-6365	65-0443-10	1.35	66-0683340	.12
65-0156	*65-0182	65-0339	1.50	65-0443-11	1.35	66-0684340	.15
65-0158	.20	65-0340	.35	65-0443-12	.75	66-0684360	.17
65-0159	*65-0046	65-0341	*45-6389-2	65-0444	1.50	66-0685340	.25
65-0160	*45-6365	65-0345	*45-7502A	65-0445	*45-7502	66-0688340	*66-0688340
65-0161	*65-0230	65-0347	4.00	65-0446	1.50	66-0688550	.12
65-0165	*45-7502A	65-0349	1.10	65-0447	*45-6389-2A	66-0753340	.12
65-0168	.50	65-0350	2.00	65-0448	2.50	66-0754340	.15
65-0169	*45-6389-2	65-0351	1.00	65-0449	1.50	66-0823340	.12
65-0170	*45-6389-2	65-0352	*65-0460	65-0450	1.50	66-0824340	.15
65-0171	*45-7502A	65-0353	*45-6365	65-0451	.35	66-0828250	.12
65-0172	*45-7502A	65-0354	4.25	65-0452	.35	66-0918250	.12
65-0173	*45-7502A	65-0356	.60	65-0453	*45-6365	66-1103240	.12
65-0177	*45-6365	65-0358	4.00	65-0454	1.25	66-1103340	.12
65-0178	*45-6365	65-0359	1.35	65-0455	3.75	66-1104340	.15
65-0179	2.75	65-0360	*65-0360-3	65-0459	1.10	66-1104360	.17
65-0182	1.50	65-0360-3	3.00	65-0460	2.00	66-1105340	.25
65-0183	1.40	65-0362	*45-6365	65-0461	*45-6365	66-1108340	.12
65-0185	*65-0404	65-0363	2.00	65-0462	*45-6365	66-1108350	.12
65-0189	1.85	65-0364	1.75	65-0463	.90	66-1123340	.12
65-0190	1.85	65-0365	2.25	65-0464	2.25	66-1123350	.12
65-0191	*65-0399	65-0366	2.50	65-0465	.35	66-1124340	.15
65-0192	2.65	65-0367	.90	65-0467	.60	66-1124360	.17
65-0194	*45-7502A	65-0370	1.25	65-0468	.60	66-1132260	.12
65-0195	1.50	65-0371	1.25	65-0469	.60	66-1133340	.12
65-0196	1.85	65-0378	.25	65-0470	.60	66-1138250	.12
65-0197	.35	65-0379	1.50	65-0471	.60	66-1153340	.12
65-0198	*45-7502A	65-0380-1	3.75	66-0103240	.12	66-1153350	.12
65-0200	*45-6389-2	65-0381	*45-6389-2	66-0103340	.12	66-1154340	.15
65-0202	*65-0204	65-0381-1	4.00	66-0104340	.15	66-1154360	.17
65-0204	.25	65-0382	.75	66-0104360	.17	66-1158250	.12
65-0214	*45-6365	65-0383	*65-0415	66-0108250	.12	66-1159350	.12
65-0221	2.50	65-0384	*65-0387	66-0108540	.12	66-1183340	.12
65-0222	.45	65-0385	*65-0264	66-0123340	.12	66-1184240	.15
65-0229	2.00	65-0386	*45-6365	66-0123360	.12	66-1184360	.17
65-0229-1	1.60	65-0387	*45-6365	66-0124340	.15	66-1185340	.25
65-0230	*45-6365	65-0388	1.50	66-0125340	.25	66-1203240	.12
65-0234	5.25	65-0389	.75	66-0153340	.12	66-1203340	.15
65-0236	*45-6365	65-0391	*65-0454	66-0154340	.15	66-1204340	.12
65-0237	*45-6365	65-0392	*45-6389-2	66-0154360	.17	66-1223240	.12
65-0238	*65-0271	65-0393	.90	66-0183240	.12	66-1223340	.12
65-0239	*45-7502A	65-0394	1.70	66-0183340	.12	66-1223350	.12
65-0240	*65-0046	65-0395	.90	66-0184340	.15	66-1224340	.15
65-0248	.15	65-0396	.75	66-0184360	.17	66-1224360	.17
65-0250	.75	65-0398	.60	66-0203340	.12	66-1225340	.25
65-0252	*45-7502A	65-0399	1.50	66-0204340	.15	66-1228250	.12
65-0255	*45-6389-2	65-0400	3.00	66-0223340	.12	66-1228340	*66-1223340
65-0256	*45-6389-2	65-0401	1.35	66-0224340	.15	66-1228520	.12
65-0257	*45-7502A	65-0402	*32-7928	66-0224360	.17	66-1244340	.15
65-0260	*65-0404	65-0403	4.75	66-0253340	.12	66-1253340	.12
65-0262	.45	65-0404	4.25	66-0254340	.15	66-1254340	.12
65-0264	*45-6365	65-0405	*45-6389-2	66-0273340	.12	66-1273340	.12
65-0265	*45-6365	65-0406	.80	66-0274340	.15	66-1274340	.15
65-0267	2.50	65-0407	1.50	66-0274360	.17	66-1274360	.17
65-0268	2.00	65-0408	2.00	66-0303340	.12	66-1303340	.12
65-0270	1.25	65-0409	2.25	66-0304340	.15	66-1304340	.15
65-0271	*45-6365	65-0410	1.85	66-0333340	.12	66-1333340	.12
65-0272	*65-0234	65-0415	2.40	66-0334340	.15	66-1334340	.15
65-0274	*45-6365	65-0416	*45-7502A	66-0334360	.17	66-1334360	.17
65-0275	*45-6365	65-0418	1.85	66-035240	.12	66-1335340	.25
65-0276	*45-6365	65-0419	*65-0277	66-0393240	.12	66-1393340	.12
65-0277	2.65	65-0420	*45-7502A	66-0393340	.12	66-1394340	.15
65-0278	8.00	65-0421	2.75	66-0394340	.15	66-1394360	.17
65-0279	*65-0277	65-0422	1.10	66-0394360	.17	66-1403340	.12
65-0293	2.50	65-0423	.75	66-0403340	.12	66-1404340	.15
65-0295	*65-0354	65-0428	.25	66-0404340	.15	66-1453340	.12
65-0301	*45-7502	65-0433	.50	66-0473340	.12	66-1454340	.15
65-0303	*45-6365	65-0436	1.85	66-0473350	.12	66-1471340	.12
65-0304	*45-6365	65-0437	.35	66-0474340	.15	66-1473340	.12
65-0305	2.60	65-0438	.20	66-0474360	.17	66-1474340	.15
65-0306	3.00	65-0439	1.00	66-0478550	.12	66-1474360	.17
65-0313	*65-0221	65-0440	1.50	66-0503340	.12	66-1475340	*66-1475360
65-0317	2.00	65-0441	1.25	66-0504340	.15	66-1475360	.15
65-0318	*65-0234	65-0443	1.50	66-0563240	.12	66-1503340	.12

* Recommended substitute.

ALL PRICES SUBJECT TO CHANGE WITHOUT NOTICE

RADIO PARTS PRICE LIST—Continued

PART NUMBER	LIST PRICE or Substitute	PART NUMBER	LIST PRICE or Substitute	PART NUMBER	LIST PRICE or Substitute	PART NUMBER	LIST PRICE or Substitute
66-1504340	.15	66-2474340	.15	66-3568340	.12	66-5154340	.15
66-1513340	.12	66-2474360	.17	66-3603340	.12	66-5183340	.12
66-1563240	.15	66-2475340	.25	66-3604340	.15	66-5184340	.15
66-1563340	.12	66-2478540	.12	66-3683240	.12	66-5203340	.12
66-1564340	.15	66-2503240	.12	66-3683340	.12	66-5204340	.15
66-1564360	.17	66-2503340	.12	66-3684340	.15	66-5223340	.12
66-1565340	.25	66-2504340	.15	66-3685340	.25	66-5224340	.15
66-1568340	.12	66-2513240	.12	66-3703340	.12	66-5253340	.12
66-1603340	.12	66-2563340	.12	66-3704340	.15	66-5254340	.15
66-1604340	.15	66-2564340	.15	66-3753240	.12	66-5271340	.12
66-1681340	.12	66-2565340	.25	66-3753340	.12	66-5273340	.12
66-1683340	.12	66-2603340	.12	66-3754340	.15	66-5274340	.15
66-1684340	.15	66-2604340	.15	66-3823340	.12	66-5278340	.50
66-1684360	.17	66-2653340	.12	66-3824340	.15	66-5303340	.12
66-1685340	.30	66-2654340	.15	66-3825340	.25	66-5304340	.15
66-1753240	.12	66-2683340	.12	66-4103340	.12	66-5333340	.12
66-1753340	.12	66-2684340	.15	66-4103351	.12	66-5334340	.15
66-1754340	.15	66-2685340	.25	66-4104340	.20	66-5353340	.12
66-1758250	.15	66-2703340	.12	66-4105340	.25	66-5354340	.15
66-1803340	.12	66-2704340	.15	66-4108540	.12	66-5393340	.12
66-1804340	.15	66-2753340	.12	66-4123340	.12	66-5394340	.15
66-1823340	.12	66-2754340	.15	66-4124340	.15	66-5403340	.12
66-1824340	.15	66-2803240	.12	66-4125340	.25	66-5404340	.15
66-1824360	.17	66-2803340	.12	66-4153340	.12	66-5473340	.12
66-1825340	.25	66-2804340	.15	66-4154340	.15	66-5474340	.15
66-2103340	.12	66-2823340	.12	66-4183340	.12	66-5503340	.12
66-2103540	.12	66-2824340	.15	66-4184340	.15	66-5504340	.15
66-2104340	.15	66-2825340	.25	66-4203340	.12	66-5563340	.12
66-2104360	.17	66-2825351	.25	66-4204340	.15	66-5564340	.15
66-2105340	.25	66-2903340	.12	66-4221340	.12	66-5603340	.12
66-2108540	.12	66-2904340	.15	66-4223340	.12	66-5604340	.15
66-2108550	.12	66-3103240	.12	66-4224250	.15	66-5683340	.12
66-2123340	.12	66-3103340	.12	66-4224340	.15	66-5684340	.15
66-2124340	.15	66-3104340	.15	66-4225340	.25	66-5823340	.12
66-2125340	.25	66-3105340	.25	66-4253340	.12	66-5824340	.15
66-2133240	.12	66-3108340	.12	66-4254340	.15	66-6103340	.12
66-2153340	.12	66-31123340	.12	66-4273340	.12	66-6104340	.15
66-2154340	.15	66-3124340	.15	66-4274340	.15	66-6123340	.12
66-2154360	.17	66-3125340	.25	66-4275340	.25	66-6124340	.15
66-2155340	.25	66-3153340	.12	66-4303340	.12	66-6153340	.12
66-2158540	.12	66-3154340	.15	66-4304340	.15	66-6154340	.15
66-2183340	.12	66-3155340	.25	66-4333340	.12	66-6183340	.12
66-2184340	.15	66-3158540	.12	66-4334340	.15	66-6203340	.12
66-2185340	.25	66-3183340	.12	66-4338350	.12	66-6204340	.15
66-2188340	.12	66-3184340	.15	66-4353340	.12	66-6154260	.15
66-2203340	.12	66-3185340	.25	66-4354340	.15	66-6154360	.17
66-2204340	.15	66-3203340	.12	66-4393340	.12	66-6184360	.17
66-2204360	.17	66-3204340	.15	66-4394240	.15	66-6274360	.17
66-2223240	.12	66-3223240	.12	66-4394340	.15	66-6303340	.12
66-2223340	.12	66-3223340	.12	66-4395340	.25	66-6304340	.15
66-2224340	.15	66-3224340	.15	66-4403340	.12	66-6334360	.17
66-2224360	.17	66-3225340	.25	66-4404340	.15	66-6473340	.12
66-2225340	.25	66-3225351	.25	66-4473340	.12	66-6474360	.17
66-2228340	.12	66-3228540	.12	66-4474340	.15	66-6513240	.25
66-2228350	.12	66-3245251	.30	66-4503340	.12	66-6513250	.15
66-2228540	.12	66-3253340	.12	66-4504340	.15	66-6685360	.20
66-2253340	.12	66-3254340	.15	66-4513240	.12	66-9824360	.17
66-2254340	.15	66-3273340	.12	66-4563340	.12		
66-2273340	.12	66-3274340	.15	66-4564240	.15	67-0002	1.35
66-2274240	.20	66-3275340	.25	66-4564250	*66-4564240	67-0003	2.00
66-2274340	.15	66-3303340	.12	66-4564340	.15	67-0004	1.35
66-2278340	.12	66-3304340	.15	66-4603340	.12	67-0005	1.35
66-2295340	.25	66-3303340	.12	66-4604340	.15	67-0006	1.35
66-2303340	.12	66-3304340	.15	66-4683340	.12	67-0008	*67-0016
66-2304340	.15	66-3335340	.25	66-4684340	.15	67-0009	*33-5410
66-2333240	.12	66-3335351	.25	66-4685340	.25	67-0010	2.00
66-2333340	.12	66-3353340	.12	66-4703340	.12	67-0011	.45
66-2334340	.15	66-3354340	.15	66-4704340	.15	67-0015	2.00
66-2334360	.17	66-3393340	.12	66-4753340	.12	67-0016	2.00
66-2335340	.25	66-3394340	.15	66-4754340	.15	67-0017	*67-0019
66-2338340	.12	66-3395340	.25	66-4803340	.12	67-0018	*67-0026
66-2338540	.12	66-3403340	.12	66-4804340	.15	67-0019	2.00
66-2353340	.12	66-3404340	.15	66-4823340	.12	67-0020	1.45
66-2354340	.15	66-3473340	.12	66-4824340	.15	67-0022	2.50
66-2393340	.12	66-3474340	.15	66-4903340	.12	67-0025	.45
66-2394340	.15	66-3475340	.25	66-4904340	.15	67-0026	2.10
66-2395340	.25	66-3503340	.12	66-5103340	.12	67-0027	2.10
66-2403340	.12	66-3504340	.15	66-5104340	.15	67-0028	2.00
66-2404340	.15	66-3563340	.12	66-5123340	.12	67-0029	.50
66-2471340	.12	66-3564340	.15	66-5124340	.15	67-0031	2.10
66-2473340	.12			66-5153340	.12	67-0032	1.35

* Recommended substitute.

ALL PRICES SUBJECT TO CHANGE WITHOUT NOTICE

RADIO PARTS PRICE LIST—Continued

PART NUMBER	LIST PRICE or Substitute	PART NUMBER	LIST PRICE or Substitute	PART NUMBER	LIST PRICE or Substitute	PART NUMBER	LIST PRICE or Substitute
67-0033	1.35	76-1161	.50	76-1409	1.85	76-1714	*76-2338
67-0035	2.75	76-1164	5.75	76-1410	1.85	76-1717	.75
67-0037	*67-0054	76-1167	.35	76-1413	11.00	76-1722FE27	.35
67-0039	*67-0054	76-1171	.35	76-1418	.45	76-1723	.60
67-0040	2.50	76-1172	.30	76-1419	.50	76-1725	23.00
67-0041	.45	76-1176	.60	76-1421	.30	76-1730	6.00
67-0042	2.00	76-1177	.35	76-1435	.30	76-1731	.60
67-0043	1.50	76-1179	.40	76-1472	.05	76-1772	†
67-0046	.50	76-1179-1	.50	76-1472-1	.10	76-1773	†
67-0047	2.10	76-1179-2	.55	76-1476	1.00	76-1775	1.85
67-0048	1.35	76-1179-5	.40	76-1485	.40	76-1776	1.85
67-0050	1.25	76-1179-6	.35	76-1495	.80	76-1777	.15
67-0051	1.50	76-1179-7	.45	76-1511	2.00	76-1779	.60
67-0052	2.10	76-1183	4.50	76-1512	.04	76-1781	2.00
67-0054	2.10	76-1192	.50	76-1515	1.60C	76-1782	5.00
67-0055	*67-0033	76-1194	2.60	76-1518	3.20C	76-1783	1.85
67-0056	2.10	76-1196	*318-2773	76-1522	.50	76-1784	2.25
67-0057	1.50	76-1198	.60	76-1530	7.30	76-1785	.60
67-0058	3.00	76-1216	1.85	76-1537	6.50	76-1786	*76-1786-1
67-0059	2.10	76-1227	.35	76-1538	5.30	76-1786-1	1.25
67-0060	2.75	76-1230	2.60	76-1539	.08	76-1787	1.35
67-0062	.60	76-1236	.40	76-1540	.08	76-1788	1.00
69-0002	.15	76-1236-1	.55	76-1540-1	2.75	76-1789	*45-1515
69-0004	*34-2039	76-1237	*76-1530	76-1543	1.60C	76-1791	1.50
73-0006	*73-0059	76-1240	1.25	76-1562	*10524R	76-1792	2.00
73-0010	*73-0056	76-1241	1.00	76-1565	*10524P	76-1794	.10
73-0013	*73-0056	76-1243	.04	76-1579	3.00	76-1794-1	.10
73-0014	*73-0059	76-1244FA33	.50	76-1588	.65	76-1814	.15
73-0015	*73-0059	76-1245	.75	76-1599	21.00	76-1855	.60
73-0016	*73-0056	76-1245-1	.55	76-1600	6.00	76-1858	.35
73-0018	*45-0002-2	76-1245-2	.70	76-1601	.90	76-1859	.50
73-0020	*45-0002-2	76-1246FA33	.25	76-1602	3.75	76-1865	.70
73-0024	*73-0059	76-1247	.30	76-1603	1.00	76-1869	*10542D
73-0027	*73-0027-1	76-1249	*10542D	76-1604	4.25	76-1870	*10542E
73-0027-1	7.00	76-1253	*76-1538	76-1605	2.75	76-1877	3.00
73-0029	*73-0059	76-1256	1.10	76-1606	1.85	76-1880	.45
73-0030	*36-1609-3	76-1263	.75	76-1608	1.25	76-1892	.25
73-0038	*73-0059	76-1270	3.00	76-1614	6.00	76-1892-4	1.00
73-0042	*36-1609-10	76-1271	3.25	76-1615	.90	76-1892-11	.25
73-0043	*73-0059	76-1273	1.10	76-1617	.45	76-1892-14	.20
73-0044	*73-0059	76-1275	*56-2190	76-1618	.50	76-1904	.90
73-0045	*36-1609-3	76-1276	.35	76-1620	2.00	76-1910	*77-0943
73-0047	*36-1609-3	76-1278	2.25	76-1622	11.50	76-1915	2.50
73-0050	*73-0056	76-1279	2.60	76-1622-1	11.50	76-1925	.15
73-0051	*36-1609-4	76-1280	.35	76-1623	.70	76-1926	.15
73-0052	*36-1609-4	76-1281	.75	76-1638	1.00	76-1940	1.35
73-0053	*36-1609-3	76-1281-1	.75	76-1640	2.25	76-1953	.60
73-0054	*36-1609-3	76-1282	.45	76-1640-1	2.50	76-1955	.45
73-0055	*36-1609-3	76-1284	1.50	76-1642	.50	76-1956	.45
73-0056	10.75	76-1292	1.85	76-1643	1.35	76-1957	.45
73-0058	10.25	76-1293	1.50	76-1644	*10629B	76-1958	.45
73-0059	*36-1609-3	76-1294	.08	76-1646	*10629C	76-1959	.45
73-0062	*36-1609-3	76-1296	5.25	76-1650	1.25	76-1960	.45
73-0063	*45-0002-1	76-1298FA3	*76-1298FA33	76-1651	.80	76-1961	.45
73-0064	*36-1609-4	76-1299	.50	76-1652	2.25	76-1964	1.25
73-0066	*36-1609-4	76-1299-1	.35	76-1653	*76-1652	76-1965	.75
73-0067	*36-1609-4	76-1299-2	.35	76-1654-2	.50	76-1966	9.00
73-0068	*36-1609-3	76-1306	2.75	76-1655	.10	76-1979	1.25
73-0071	*73-0055	76-1323	.75	76-1655-1	.10	76-1980	1.00
73-0072	*36-1609-4	76-1340	2.60	76-1655-2	.35	76-1981	.45
73-0074	11.75	76-1343	.15	76-1658	.32	76-1984	.58
76-1051	2.00	76-1346	*27-4788	76-1666	*76-1966	76-1985	.20
76-1057FA33	3.35	76-1353	.60	76-1671	.50	76-1989	2.50
76-1075	.20	76-1356	.50	76-1672	.90	76-1989-2	3.00
76-1079	*76-1171	76-1357	.50	76-1672-1	.90	76-1990	*77-0588-1
76-1086	4.00	76-1358	3.25	76-1677	.50	76-2003	1.50
76-1087	4.00	76-1360	5.60	76-1677-1	.15	76-2003-1	1.00
76-1090	*76-1183	76-1362	*27-4788	76-1677-2	.20	76-2005	1.85
76-1104	1.10	76-1363	1.60	76-1677-3	.20	76-2005-2	2.25
76-1107	1.50	76-1368	*76-1372	76-1678	.15	76-2005-3	1.50
76-1109	5.00	76-1374FCP	.70	76-1696	2.40	76-2022	1.40
76-1110	*318-2741	76-1376	.15	76-1691	{ leaW 2502	76-2023	.75
76-1115	.25	76-1384	*27-4788	76-1691	{ lea54-4122	76-2025	.35
76-1122	.20	76-1386	3.50	76-1691	{ lea56-2293	76-2027	.30
76-1134	5.95	76-1387	*27-4788	76-1691	{ leaW 2271	76-2028	.40
76-1135	14.00	76-1390	1.80	76-1696	1.60	76-2029	.50
76-1141	1.50	76-1392	.60	76-1702	3.00	76-2029-4	.45
76-1144	25.00	76-1394	*27-4788	76-1703	.15	76-2029-5	.45
		76-1395	4.50	76-1712	.55	76-2029-9	.80
		76-1399	*27-4788	76-1713	.70	76-2029-10	1.00

* Recommended substitute.
† Refer to distributor.

ALL PRICES SUBJECT TO CHANGE WITHOUT NOTICE

RADIO PARTS PRICE LIST—Continued

PART NUMBER	LIST PRICE or Substitute	PART NUMBER	LIST PRICE or Substitute	PART NUMBER	LIST PRICE or Substitute	PART NUMBER	LIST PRICE or Substitute
76-2029-12	1.00	76-2186-4	.30	76-2407	1.00	76-2833-1	1.85
76-2043	.35	76-2186-6	.35	76-2408	7.00	76-2833-2	1.85
76-2050	1.35	76-2187	.20	76-2409	3.00	76-2833-3	1.85
76-2051	.04	76-2188	4.00	76-2410	4.00	76-2833-4	1.50
76-2053	1.50	76-2194	.20	76-2411	2.00	76-2833-5	1.85
76-2057	1.50	76-2195	1.80	76-2412	.35	76-2833-6	1.85
72-2060	1.10	76-2197	2.00	76-2413	1.40	76-2833-7	1.75
76-2066	.35	76-2198	4.00	76-2414	.50	76-2833-8	1.85
76-2070-21	.40	76-2199	5.00	76-2415	1.85	76-2833-9	1.75
76-2070-34	.30	76-2200	3.50	76-2416	1.25	76-2833-10	1.85
76-2070-35	.35	76-2201	.45	76-2426	5.50	76-2833-11	1.75
76-2070-45	.45	76-2206	.35	76-2429-2	2.75	76-2833-12	1.75
76-2070-55	.75	76-2211	5.50	76-2430	*10647E	76-2834	1.85
76-2070-82	.45	76-2214	.20	76-2432	3.00	76-2838	1.75
76-2070-88	.35	76-2223-1	*76-2429-1	76-2436	2.25	76-2872	1.85
76-2070-91	.45	76-2223-2	2.40	76-2437	6.00	76-2872-1	1.85
76-2070-92	.95	76-2226	3.75	76-2448	1.20	76-2878	2.25
76-2079	1.50	76-2226-2	3.50	76-2468-1J3-1	2.50	76-2878-1	2.00
76-2087	1.00	76-2226-3	3.50	76-2470	.35	76-2878-2	1.60
76-2088	1.10	76-2226-4	3.75	76-2475	.60	76-2879FJ21	2.75
76-2093	1.35	76-2226-5	4.25	76-2480	3.50	76-2879-2J22	3.25
76-2094	.50	76-2236	1.45	76-2481	9.50	76-2879-3J21	3.75
76-2095	.55	76-2236-1	1.40	76-2482	2.00	76-2882	2.00
76-2096	8.50	76-2237	2.40	76-2483	.60	76-2883	1.75
76-2097	*76-2613	76-2252	.30	76-2485	.90	76-2884	1.35
76-2100	.45	76-2254	3.50	76-2496	.90	76-2890	1.50
76-2101	.80	76-2258	.75	76-2497	.90	76-2891	1.10
		76-2261	.15	76-2499	4.50	76-2895	1.40
		76-2262	2.75	76-2500	.30	76-2896	1.30
76-2102	{ *lea76-2537	76-2262-1	3.00	76-2505	.20	76-2898	1.10
	{ *lea56-3877	76-2262-2	.35	76-2506	.20	76-2902	1.40
	{ *lea1W19828FA3	76-2264	3.50	76-2537	.30	76-2910	.90
76-2103	.20	76-2267	.75	76-2556	.15	76-2911	1.00
76-2106	2.80	76-2270	.35	76-2557	.30	76-2912	.50
76-2107	.60	76-2271	.15	76-2573	1.10	76-2913	.50
76-2108	3.00	76-2273	.15	76-2580	3.75	76-2919	8.50
76-2109	.20	76-2273-1	.15	76-2587	.45	76-2919-1	11.00
76-2109-1	.30	76-2324	3.75	76-2591	{ *lea56-4008	76-2921	1.20
76-2109-2	.25	76-2326	3.00		{ *lea1W27714FE7	76-2924	.70
76-2109-3	.30	76-2327	.90	76-2613	.60	76-2924-1	1.00
76-2111	1.00	76-2333-1	.75	76-2614	.50	76-2925	2.75
76-2114	.55	76-2338	1.85	76-2616	11.50	76-2927	1.80
76-2124	2.75	76-2339	*76-2339-1	76-2622-1	11.50	76-2930	.65
76-2126	*10647E	76-2339-1	.75	76-2622-2	11.00	76-2930-1	1.25
76-2127	.50	76-2341	4.50	76-2622-3	13.00	76-2930-2	1.30
76-2127-1	.70	76-2342	1.00	76-2623	4.80	76-2930-3	.75
76-2127-3	.75	76-2343	1.00	76-2629	.60	76-2945	12.25
76-2127-4	.70	76-2344	3.00	76-2631	*76-2631-1	76-2949	.60
76-2127-5	.75	76-2346	1.75	76-2631-1	22.50	76-2951	2.50
76-2127-7	.50	76-2348	.30	76-2634	1.20	76-2953-1FCP	.75
76-2127-8	.60	76-2349	.30	76-2646	1.50	76-2953FCP	2.25
76-2127-9	.55	76-2350	.30	76-2661	4.25	76-2955	5.00
76-2134	.50	76-2353	5.95	76-2662	3.00	76-2957	3.75
76-2140	*76-2140-2	76-2353-1	*45-1598	76-2664	3.75	76-2974	3.00
76-2140-1	*76-2140-2	76-2354	*76-2353	76-2664-1	*45-9519	76-2978	.75
76-2140-2	1.10	76-2355	*76-2353	76-2678	2.75	76-2982	.15
76-2142	.35	76-2356FA3	.75	76-2695	8.50	76-2982-1	.15
76-2142-2	.40	76-2356-1FA3	.75	76-2695-1	3.50	76-2983	.75
76-2142-3	.60	76-2360	1.25	76-2695-2	3.00	76-2984	1.65
76-2148	.08	76-2361	1.00	76-2695-3	3.50	76-2987	.25
76-2150	.65.00	76-2362	.28	76-2696	.30	76-2988	*76-2988-2
76-2151	1.20	76-2364	4.00	76-2699	3.50	76-2988-1	*76-2988-2
76-2153	.15	76-2367	2.85	76-2715	10.00	76-2988-2	8.50
76-2154	.20	76-2368	2.75	76-2716	.85	76-2988-3	*318-2971
76-2155	3.50	76-2369	.50	76-2728	2.75	76-2989	1.25
76-2156	4.00	76-2370	.50	76-2728-5	2.25	76-2990	.50
76-2156-1	4.25	76-2374	1.20	76-2746	2.75	76-2991	.45
76-2157	.60	76-2375	3.00	76-2746-1	1.85	76-3015FJ21	1.75
76-2158	.60	76-2379	.85	76-2777	1.00	76-3017FJ22	1.40
76-2165	1.25	76-2380	.50	76-2779	5.25	76-3020	4.00
76-2169	.35	76-2381	.50	76-2813	1.00	76-3026	2.70
76-2170	1.25	76-2381-1	.08	76-2817	2.25	76-3037	.65
76-2171	.35	76-2381-2	.60	76-2832	1.10	76-3040	1.65
76-2172	1.25	76-2381-3	.50	76-2832-1	1.85	76-3041FJ41	4.75
76-2172-1	.90	76-2389	2.00	76-2832-2	1.25	76-3051	.60
76-2173	.05	76-2389-1	2.25	76-2832-3	1.85	76-3054	.15
76-2174	3.50	76-2389-2	3.50	76-2832-4	1.85	76-3055FJ31	9.00
76-2174-1	2.50	76-2390	1.50	76-2832-5	1.85	76-3058FJ31	9.00
76-2176	3.50	76-2393	9.00	76-2833	1.85	76-3059	1.00
76-2186	.20	76-2394	3.00			76-3061	1.00
76-2186-2	.20	76-2406	.18				
76-2186-3	.35						

* Recommended substitute.

ALL PRICES SUBJECT TO CHANGE WITHOUT NOTICE

RADIO PARTS PRICE LIST—Continued

PART NUMBER	LIST PRICE or Substitute	PART NUMBER	LIST PRICE or Substitute	PART NUMBER	LIST PRICE or Substitute	PART NUMBER	LIST PRICE or Substitute
76-3065	.35	76-3320	*76-3322	76-3892	2.75	76-4298	2.50
76-3067	.35	76-3322	11.00	76-3913	2.75	76-4309	2.50
76-3067-1	.90	76-3324	.50	76-3917	.40	76-4315-1	.50
76-3069FJ1	1.85	76-3325	.60	76-3918	1.50	76-4321	.60
76-3074	1.00	76-3332	1.80	76-3919	.30	76-4333	1.25
76-3074-1	.60	76-3348	8.50	76-3926	3.50	76-4335	1.70
76-3074-2	.40	76-3349	23.00	76-3931	.35	76-4337	1.20
76-3076	15.00	76-3351	2.00	76-3932	5.50	76-4337-1	1.25
76-3087	1.50	76-3354FJ21	4.50	76-3938	17.00	76-4344	10.00
76-3109	17.25	76-3355FJ21	2.10	76-3949	12.50	76-4355	21.00
76-3109-1	17.50	76-3375	5.75	76-3958FJ21	2.00	76-4357	.85
76-3109-2	20.00	76-3377	3.00	76-3959	.50	76-4385	1.75
76-3110	5.00	76-3429	2.75	76-3961	1.90	76-4386FA3	1.50
76-3110-1	5.00	76-3456	4.25	76-3964	5.25	76-4396	3.25
76-3110-3	5.75	76-3461	2.40	76-3971	6.00	76-4413	2.10
76-3124	.45	76-3479	.90	76-3972	.70	76-4431	.50
76-3124-1	.20	76-3479-1	.50	76-3981	10.00	76-4437	1.10
76-3126	1.75	76-3530	1.00	76-3982	.50	76-4463	.75
76-3128	1.50	76-3547	1.20	76-3985	1.10	76-4465	5.25
76-3131	2.40	76-3556	.75	76-3986	5.00	76-4477	.70
76-3134	2.00	76-3557	1.25	76-3986-1	5.00	76-4485	1.25
76-3136	8.50	76-3575	.50	76-3993	2.50	76-4487	.85
76-3138	1.10	76-3576	20.00	76-3994	4.70	76-4516	36.00
76-3138-1	.75	76-3583	.45	76-3995	2.20	76-4517	36.00
76-3139	1.75	76-3583-1	.80	76-3997	.75	76-4519	.25
76-3140	.85	76-3583-2	.60	76-3998	1.65	76-4547	6.50
76-3142	2.25	76-3583-3	.50	76-4001	1.40	76-4560	20.00
76-3145	1.00	76-3583-4	.45	76-4004	.30	76-4560-1	20.00
76-3155	3.25	76-3583-5	.70	76-4005	1.15	76-4562	.25
76-3164	1.50	76-3583-6	.90	76-4010	6.75 C	76-4564	10.00
76-3167	.65	76-3583-8	.75	76-4026	7.00	76-4564-1	10.00
76-3171	45.00	76-3583-9	.70	76-4027	1.00	76-4566	4.75
76-3176	1.50	76-3583-10	.85	76-4034	.55	77-0032	*77 0178
76-3177	.25	76-3584	.50	76-4041	1.75	77-0034	3.00
76-3178	1.85	76-3585	1.85	76-4043	.50	77-0052	.30
76-3185	*56-4925	76-3586	.20	76-4053	*45-9550	77-0061	*85 0021
76-3185-2	*56-4925-1	76-3587	.60	76-4072	.60	77-0087	1.80
76-3185-3	*56-4925-3	76-3588	1.20	76-4073	.60	77-0098	.75
76-3185-4	*56-4925-4	76-3589	1.50	76-4075	.70	77-0099	.60
76-3185-5	*56-4925-5	76-3590	2.25	76-4079	.70	77-0108	5.00
76-3187	3.25	76-3591	.90	76-4082	8.75	77-0120	5.00
76-3187-1	3.25	76-3592	.26	76-4083	1.30	77-0135	*77 0175
76-3187-2	3.25	76-3596	3.50	76-4086	1.00	77-0148	5.00
76-3187-4	4.00	76-3599	55.00	76-4089	1.00	77-0160	2.25
76-3187-5	2.75	76-3600	.25	76-4089-1	1.00	77-0174	3.25
76-3187-6	3.00	76-3601	.75	76-4092	1.10	77-0178	13.00
76-3202	15.00	76-3612	3.60	76-4098	.65	77-0179	11.50
76-3202-1	*76-3202	76-3624	4.40	76-4099	2.25	77-0191	*38 9438
76-3202-2	20.00	76-3639FJ21	1.25	76-4104	7.00	77-0204	11.50
76-3203	.20	76-3656	1.00	76-4104-1	6.25	77-0207	3.00
76-3204	.35	76-3668	.80	76-4117	.95	77-0217	.20
76-3215	2.50	76-3668-1	*76-3668	76-4134	.25	77-0229	11.50
76-3218	4.00	76-3671	.50	76-4134-1	.25	77-0233	*77-0352
76-3221FA9	.65	76-3671-1	.50	76-4162	37.50	77-0235	.35
76-3222	7.50	76-3671-2	.50	76-4164	.40	77-0247	*85 0087
76-3222-1	6.50	76-3672	2.50	76-4167	2.00	77-0250	.50
76-3223	3.00	76-3674	.20	76-4189	.90	77-0252	.60
76-3223-1	3.00	76-3702	.10	76-4192	10.00	77-0257	8.00
76-3223-2	2.50	76-3703	.10	76-4193	.35	77-0259	*77-0257
76-3223-3	2.50	76-3713	1.35	76-4194	1.50	77-0336	.20
76-3223-5	2.25	76-3716	1.50	76-4196	.60	77-0342	.15
76-3223-6	2.25	76-3731	.60	76-4197	.50	77-0344	*77-0480
76-3223-7	2.50	76-3731-1	.70	76-4198	.35	77-0352	.50
76-3223-8	2.50	76-3741	4.00	76-4201	10.00	77-0354	9.00
76-3223-9	2.25	76-3742	*76-4089-1	76-4204	.50	77-0362	.75
76-3228	1.15	76-3774	*76-4162	76-4225	*56-5956FCP	77-0388	*77-0403
76-3229	1.10	76-3796	14.00	76-4228-1	14.00	77-0397	3.75
76-3237	.15	76-3808FJ31	6.90	76-4229-1	10.00	77-0400	.10
76-3246	2.00	76-3820	.50	76-4232	1.50	77-0402	.80
76-3253	75.00	76-3833	.75	76-4235	2.40	77-0403	1.00
76-3274	8.50	76-3837	.25	76-4236	.70	77-0409	*77 0571
76-3275	3.25	76-3841	2.50	76-4237	.45	77-0412	*77 0558
76-3275-1	3.00	76-3859	2.00	76-4238	.40	77-0413	*77 0469
76-3282	6.00	76-3880	1.50	76-4239	.60	77-0440	*77 0480
76-3282-1	6.00	76-3880-1	1.60	76-4245	.60	77-0447	.75
76-3288	2.00	76-3880-2	1.50	76-4252	3.00	77-0448	.75
76-3288-1	2.00	76-3880-3	1.20	76-4252-1	1.50	77-0454	1.50
76-3298	1.00	76-3880-4	1.20	76-4252-2	1.50	77-0459	.50
76-3310	3.00	76-3880-5	1.20	76-4263	.50	77-0468	*77-0480
76-3311-3	1.50	76-3880-6	1.15	76-4268	.35	77-0469	6.75

* Recommended substitute.

ALL PRICES SUBJECT TO CHANGE WITHOUT NOTICE

RADIO PARTS PRICE LIST—Continued

PART NUMBER	LIST PRICE or Substitute	PART NUMBER	LIST PRICE or Substitute	PART NUMBER	LIST PRICE or Substitute	PART NUMBER	LIST PRICE or Substitute
77-0474	2.50	77-0765	.25	77-1023FA8	3.75	85-0106	.90
77-0477	*77-0723	77-0766	1.00	77-1024	*77-1178	85-0111	*42-1679
77-0478	*77-0723	77-0767	.75	77-1025	.30	85-0112	.45
77-0480	6.75	77-0771	1.20	77-1025-1	.20	85-0117	*91-0135
77-0481	5.25	77-0772	1.50	77-1025-2	.20	85-0118	5.00
77-0485	.20	77-0773	3.00	77-1025-3	.20	85-0121	*85-0132
77-0511	5.25	77-0776	1.50	77-1025-4	.30	85-0122	*42-1562
77-0512	3.75	77-0778	2.25	77-1026	.20	85-0123	.30
77-0514	1.20	77-0780	1.50	77-1027	1.50	85-0125	.70
77-0526	.75	77-0788	.85	77-1028	*77-1128	85-0126	.75
77-0541	.20	77-0789	1.10	77-1030	1.00	85-0127	5.00
77-0545	.75	77-0797	.45	77-1031	.35	85-0128	.75
77-0549	15.00	77-0801	.35	77-1039FC59	3.00	85-0132	15.00
77-0558	10.00	77-0802	14.00	77-1042	*77-0888	85-0133	*42-5865
77-0560	2.25	77-0805	.35	77-1043	.40	85-0134	*42-5866
77-0561F120	2.50	77-0807	6.00	77-1051FA38	1.85	85-0143	14.00
77-0561F122	3.00	77-0809	*77-1128	77-1052	*77-1011	85-0146	16.00
77-0567	2.50	77-0812	16.00	77-1053	.30	85-0148	16.00
77-0571	3.00	77-0815	12.00	77-1054	.30	85-0151	.75
77-0572	1.50	77-0817	3.75	77-1055	.30	85-0152	1.50
77-0587	*57-1949	77-0831	.45	77-1056	*77-1011	85-0155	1.25
77-0588-1	25.00	77-0834	2.25	77-1057	.30	85-0157	6.50
77-0588-2	20.00	77-0836	1.50	77-1073	.60	85-0157-1	6.75
77-0588-3	25.00	77-0837	1.85	77-1077	1.50		
77-0592	*95-0227	77-0841	1.85	77-1086	.60	89-0013	.15
77-0593	1.50	77-0854-1	.70	77-1108	.03		
77-0600	11.00	77-0848	*77-0654	77-1120	3.75	91-0024	2.00
77-0601	11.50	77-0854	3.75	77-1120-1	3.75	91-0026	*91-0102
77-0612	*77-0888	77-0863	1.10	77-1128	.25	91-0028	2.00
77-0618	.90	77-0865	16.00	77-1172	4.75	91-0042	1.75
77-0622	.60	77-0868FC51	4.50	77-1177FC59	5.50	91-0058	*36-4166
77-0623	1.00	77-0885	1.10	77-1178FA41	5.00	91-0135	10.00
77-0627	.30	77-0887	.35	77-1180FA41	5.25	91-0165	*91-0255
77-0633	*77-0654	77-0888	.30	77-1187	3.10	91-0184	10.00
77-0635	14.00	77-0890	.90	77-1196	*77-0890	91-0206	8.00
77-0638	.65	77-0891	20.00	77-1206	.60	91-0208	8.50
77-0639	.75	77-0899	12.00	77-1207	.60	91-0219	*45-2989-1
77-0640	9.00	77-0902	1.75	77-1247	5.00	91-0220	*45-2985
77-0646	.30	77-0909	.70	77-1248	.20	91-0226	2.00
77-0647	.50	77-0912	2.25	77-1256	*57-0590	91-0228	2.00
77-0649	.45	77-0913	*77-0762			91-0230	9.25
77-0651	.50	77-0914	.35	81-0077	*61-0037	91-0238	2.00
77-0654	.20	77-0915	.30	81-0130	*67-0011	91-0247	10.00
77-0657	14.00	77-0915-1	2.25	81-0192	*81-0318	91-0255	2.00
77-0657-1	20.00	77-0916	.35	81-0256	*81-0318	91-0256	13.50
77-0666	9.00	77-0917	.35	81-0271	*67-0041		
77-0666-2	8.75	77-0918	.35	81-0361	5.25	95-0073	.15
77-0667	.75	77-0919	.35	81-0380	.45	95-0123-1	1.50
77-0668	.30	77-0920	.35	81-0395	2.25	95-0135	.35
77-0669	*77-0738	77-0921	.35	81-0397	9.50	95-0135-1	1.00
77-0676	*77-0767	77-0922	*77-0921	81-0438	5.25	95-0140	1.15
77-0677	.20	77-0923	.30			95-0161	.30
77-0678	.65	77-0927	2.25	83-0001	*77-0178	95-0166	1.50
77-0681	.20	77-0928	3.25	83-0014	*83-0026	95-0171	1.00
77-0687	*77-0654	77-0935	.75	83-0017	*83-0026	95-0181	1.50
77-0688	.35	77-0936	.75	83-0025	*45-6307	95-0211-1	2.50
77-0689	*77-0654	77-0941FJ39	1.75	83-0026	*83-0026A	95-0224	1.85
77-0694	3.00	77-0941FC64	2.50	83-0026A	3.50	95-0227	.50
77-0695	4.50	77-0943	14.50	83-0027	*83-0026	95-0227	1.75
77-0701	5.50	77-0947	2.25	83-0028	*83-0026	95-0236	1.75
77-0706	9.50	77-0948	*77-0654	83-0029	*83-0026	95-0248	3.25
77-0708	.50	77-0962	7.00	83-0031	*83-0026		
77-0709	7.00	77-0966	.30			97-0038	.30
77-0712	.75	77-0970	10.00	85-0011	.45	97-0054FA3	.75
77-0714FJ21	5.00	77-0970-1	*77-0588-1	85-0012	*85-0087	97-0061FA3	.08
77-0715	.75	77-0973	*76-1955	85-0014	*85-0087	97-0073FA1	.01
77-0721	.30	77-0974	*76-1961	85-0017	*83-0026	97-0091FA1	.08
77-0723	.60	77-0976	*76-1955	85-0019	.70	97-0091-1FA15	.05
77-0724	.75	77-0977	*76-1961	85-0020	1.00	97-0132	.06
77-0733	.35	77-0979	*76-1955	85-0021	23.00	97-0135FA3	.08
77-0735	.35	77-0980	*76-1955	85-0030	4.75	97-0136	*1W56913FA3
77-0738	.30	77-0984	*77-0654	85-0031	7.50	97-0140	3.75
77-0739	*57-1846			85-0041	6.75	97-0142FA3	*97-0142FA26
77-0740	9.00	77-1011	.20	85-0042	.55	97-0142FA26	.05
77-0751	3.75	77-1011-1	.20	85-0052	.45	97-0170	45
77-0752	3.75	77-1011-2	.20	85-0079	.90	97-0177FA3	.10
77-0755	1.25	77-1012	.20	85-0087	1.50	97-0178	.08
77-0760	3.25	77-1014	.35	85-0091	.35	97-0188	.30
77-0762	4.00	77-1019	1.25	85-0093	.30	97-0189	.20
77-0764	.50	77-1022	*77-1180	85-0102	*42-1679	97-0191	.45

* Recommended substitute.

ALL PRICES SUBJECT TO CHANGE WITHOUT NOTICE

RADIO PARTS PRICE LIST—Continued

PART NUMBER	LIST PRICE or Substitute	PART NUMBER	LIST PRICE or Substitute	PART NUMBER	LIST PRICE or Substitute	PART NUMBER	LIST PRICE or Substitute
97-0201	.06	318-1991FC-46	2.25	L-3356	.85	AD-2057	.35
97-0202	.06	318-2011FC-46	2.25	L-3363	.85	AD-2058	.50
97-0203	.50	318-2055	.75	L-3397-2FE9	1.50 C	AD-2059	.85
97-0229FA3	.05	318-2119	1.00			AD-2060	.20
97-0241	.35	318-2168	318-2641	5L-1048	*5L-1245	AD-2061	.20
97-0248	.05	318-2376	.20	5L-1245	.25	AD-2062	.15
		318-2624	*32-2171			AD-2063	.15
217-1057	.15	318-2639	*318-2668	AD-1008	*45-0001-1	AD-2064	.20
217-1260	.15	318-2641	5.75	AD-1009	*45-0002-3	AD-2065	3.50
217-1386	.60	318-2654	3.00	AD-1010	*45-0002-4	AD-2066	.20
217-1391	.20	318-2663	318-2773	AD-1011	*45-0002-5	AD-2067	.15
217-1396	.20	318-2668	1.60	AD-1012	*45-0004-1	AD-2068	.15
217-1397	.08	318-2678	*56-1883	AD-1013	*45-0004-3	AD-2069	2.00
217-1398	.03	318-2741	4.50	AD-1014	*45-0007-3	AD-2070	1.25
217-1406	.03	318-2755	1.50	AD-1015	*36-1535	AD-2071	5.00
217-1409	*11W52489	318-2768	1.10	AD-1017	3.00	AD-2072	5.25
217-1419	.02	318-2770	318-2786	AD-1018	2.25	AD-2073	.30
		318-2773	.50	AD-1022	1.60	AD-2074	.20
218-1047	.07	318-2785	2.50	AD-1024	2.30	AD-2075	2.50
218-1340	*56-2027	318-2786	6.00	AD-1025	2.50 C	AD-2076	2.70
218-1378	.08	318-2787	5.25	AD-1026	.75	AD-2077	2.00
218-1383	*218-1456	318-2789	312-1011	AD-1035	.30	AD-2078	6.25
218-1388	.08	318-2790	1.10	AD-2000	*76-2500	AD-2079	2.75
218-1391	.35	318-2793	.75	AD-2001	.50	AD-2080	8.00
218-1393	.08	318-2794	AD-1017	AD-2002	.50	AD-2081	2.50
218-1396	.08	318-2798	.50	AD-2003	1.00	AD-2082	6.00
218-1398	.05	318-2800	1.50	AD-2004	1.00	AD-2083	.65
218-1401	*45-6388	318-2801	318-2837	AD-2005	1.00	AD-2084	1.85
218-1402	*AD-1017	318-2802	*45-1548	AD-2006	1.00	AD-2085	.60
218-1403	.03	318-2804	1.85	AD-2007	.50	AD-2086	.20
218-1406	.05	318-2805	4.50	AD-2008	.50	AD-2087	6.25
218-1408	.15	318-2806	3.75	AD-2009	1.80	AD-2088	3.90
218-1409	.15	318-2807	5.50	AD-2010	.50	W-55	2.00 C
218-1424	.20	318-2810	312-1011	AD-2011	.50	W-98	1.25 C
218-1425	.10	318-2811	1.15	AD-2012	.50	W-112	.25 C
218-1426	.09	318-2813	.90	AD-2013	.50	W-136	.60 C
218-1427	.20	318-2814	.75	AD-2014	1.00	W-139	.25 C
218-1428	.02	318-2815	.35	AD-2015	.50	W-149	.45 C
218-1432	.02	318-2816	.90	AD-2016	.50	W-151	.20 C
218-1434	.08	318-2817	.08	AD-2017	3.25	W-152	.20 C
218-1439	.05	318-2820	1.10	AD-2018	25.00	W-204	.45 C
218-1440	.35	318-2837	3.00	AD-2019	2.00	W-206	.35 C
218-1445	.10	318-2839	218-1502	AD-2020	.15	W-223	.45 C
218-1446	.03	318-2875	312-1011	AD-2021	.15	W-239	.75 C
218-1447	.08	318-2882	.75	AD-2022	.45	W-257	*1W24516FA2
218-1449	.20	318-2977	.70	AD-2023	.45	W-307FA3	.05
218-1450	.02	318-2978	3.50	AD-2024	.35	W-417FA3	.20 C
219-1451	.20	318-4336	*76-2252	AD-2025	.30	W-434	1.50 C
218-1452	.08			AD-2026	1.00	W-443FA3	2.10 C
218-1453	.03	412-1024	2.25	AD-2027	3.00	W-464	.55 C
218-1454	.05			AD-2028	2.00	W-479	1.40
218-1455	.08	415-1012	2.40	AD-2029	1.40	W-523	1.85 C
218-1458	.06	415-1013	.90	AD-2030	3.50	W-535FA3	1.30 C
218-1459	.06	415-1014	.90	AD-2031	.90	W-630FA3	1.48 C
218-1460	.20	415-1020	1.00	AD-2032	.90	W1644FA3	1W19870FA3
218-1461	.02	415-1027	5.00	AD-2033	.50	W-661	1.50 C
218-1462	.20	415-1039	*218-1073	AD-2034	.50	W-685	1W19644FA3
218-1463	.10	415-1040	.20	AD-2035	.50	W-685FA3	1W19644FA3
218-1465	.04	415-1065	1.50	AD-2036	.50	W-708FA3	1.70 C
218-1466	.02			AD-2037	.50	W-745FA3	1.25 C
218-1468	.15	L-1591	.05	AD-2038	.50	W-752	*1W24258FA3
218-1471FA-9	.08	L-1843FE-9	.01	AD-2039	.50	W-758FA3	1.30 C
218-1501	.03	L-2183	1.10	AD-2040	.50	W-763	3.00 C
218-1502	2.75	L-2849	1.25	AD-2041	.50	W-895	5.00 C
218-1507	.04	L-2969A	.20	AD-2042	.50	W-1374	.35 C
218-1524	.08	L-3183-1	.85	AD-2043	.50	W-1406	3.00 C
		L-3183-2	1.00	AD-2044	.50	W-1549	1.50 C
312-1011	3.50	L-3185	1.10	AD-2045	.50	W-1469FA3	1.10 C
		L-3199	*L-2183	AD-2046	1.50	W-1532FA3	3.55 C
315-1002	.15	L-3246	*L-2183	AD-2047	.90	W-1567	1.55 C
315-1003	.15	L-3261	*L-2183	AD-2048	.90	W-1575FA3	.04
315-1019	1.70	L-3274	.85	AD-2049	.90	W-1582FA3	W-1582FA26
315-1021	3.75	L-3275	.30	AD-2050	1.25	W-1582FA26	1.30 C
315-1022	.65	L-3307	.85	AD-2051	1.25	W-1586FA3	3.90 C
315-1039	.15	L-3338	.08	AD-2052	6.50	W-1587	.05
		L-3339	.85	AD-2053	*45-3500-8	W-1589	.50 C
318-1374	.50	L-3344	.35	AD-2054	1.25	W-1641	2.00 C
318-1782	*77-0571	L-3351	.85	AD-2055	38.00	W-1649	.60 C
318-1795	*77-0474	L-3355	.05	AD-2056	3.25	W-1668	1.50 C
318-1892	.90					W-1636FA3	.35 C

* Recommended substitute.

ALL PRICES SUBJECT TO CHANGE WITHOUT NOTICE

RADIO PARTS PRICE LIST—Continued

PART NUMBER	LIST PRICE or Substitute	PART NUMBER	LIST PRICE or Substitute	PART NUMBER	LIST PRICE or Substitute	PART NUMBER	LIST PRICE or Substitute
W-1695	.05	1W10912FA3	1.00 C	1W18833FA1	1.90 C	1W23129FA3	2.60 C
W-1732	.75 C	1W10914FA22	.80 C	1W18836FA3	5.10 C	1W23138FA3	2.00 C
W-1775FA3	3.20 C	1W10933FA3	1.50 C	1W19023	1.10 C	1W23166FA2	3.40 C
W-1822FE11	1W25328FE11	1W10934FA3	.75 C	1W19093FA22	2.70 C	1W23167FA22	1.50 C
W-1851FJ22	4.50 C	1W10935FA3	2.20 C	1W19157FA3	3.50 C	1W23178FA2	3.70 C
W-1866	2.00 C	1W10939FA22	1.10 C	1W19159FA3	4.00 C	1W23179FA3	3.40 C
W-1958	.40 C	1W10940FA22	1.10 C	1W19248FA3	3.50 C	1W23181FA3	3.30 C
W-2022FA3	9.10 C	1W10941FA3	1.45 C	1W19289FA22	1.50 C	1W23243FA3	3.50 C
W-2023FA9	1.60 C	1W11325FA22	1.10 C	1W19329FA3	3.40 C	1W23245FA3	3.50 C
W-2032FA3	5.00 C	1W11327FA22	1.20 C	1W19355FA3	1.80 C	1W23246FA3	3.50 C
W-2065FA3	1.50 C	1W11332FA2	.90 C	1W19369FA22	3.45 C	1W23299FA9	2.60 C
W-2073	2W25468FE26	1W11510FA3	1.30 C	1W19432FA22	1.05 C	1W23366FA3	3.30 C
W-2076FA9	.50 C	1W11510FA22	1.10 C	1W19434FA22	1.50 C	1W23402FA8	5.75 C
W-2123FA3	4.30 C	1W11512FA22	1.30 C	1W19435FA3	1.90 C	1W23749FA3	900 C
W-2134	1.00 C	1W11882FA22	1.20 C	1W19466FA22	2.50 C	1W23750FA3	3.65 C
W-2135	.45 C	1W11883FA3	.05	1W19447	3.50 C	1W23992FA3	19W23753
W-2150	1.75 C	1W11888FA3	2.20 C	1W19451FA22	3.00 C	1W24254FA3	300 C
W-2158	1.00 C	1W12063FA1	5.30 C	1W19590FA3	2.70 C	1W24255FA3	.35 C
W-2159	.15	1W12063FA2	1.10 C	1W19592FA22	3.50 C	1W24256FA3	1.10 C
W-2190	5.00 C	1W12067FA22	1.50 C	1W19644FA3	2.00 C	1W24256FA14	3.40 C
W-2200FA11	3.00 C	1W12179FA22	1.90 C	1W19670FA3	1.00 C	1W24256FA43	.70 C
W-2204FA8	1.50 C	1W12180FA22	1.10 C	1W19672FA3	1.10 C	1W24257FA1	.60 C
W-2225	2.00 C	1W12181FA3	.02	1W19673FA3	1.00 C	1W24257FA3	1.10 C
W-2235FA9	2.00 C	1W12182FA22	3.00 C	1W19674FA3	1.25 C	1W24257FA14	.45 C
W-22351FA9	2.20	1W12495FA3	2W10915	1W19675FA3	1.25 C	1W24258FA1	1.00 C
W-22352FA9	2.75	1W12496FA3	1.25 C	1W19676FA9	1.10 C	1W24258FA3	1.10 C
W-2235FA9	2.00 C	1W12513FA1	3.80 C	1W19686FA3	2.75 C	1W24258FA22	.70 C
W-2245	.70 C	1W12517FA14	1.00 C	1W19687FA3	1.50 C	1W24259FA1	1W24259FA14
W-2254FA33	.10	1W12631FA3	1.25 C	1W19749FA3	1.50 C	1W24259FA14	.80 C
W-2271FA3	4.00 C	1W12655FA3	1.00 C	1W19749FA22	2.60 C	1W24260FA3	1.25 C
W-2276FA14	.12	1W12901FA3	1.50 C	1W19751FE15	1.00 C	1W24260FA43	4W24260FA43
W-2279	1.00 C	1W12902FA3	1W12091FA3	1W19752FA3	2.00 C	1W24263FA2	1.70 C
W-2284	2.00 C	1W12922FA3	5.00 C	1W19752FA22	1W19754FA3	1W24263FA14	1.40 C
W-2289	1W10684	1W13074FE27	1.00 C	1W19753FA3	1.80 C	1W24263FA43	2.25 C
W-2290	3.00 C	1W13082FE27	5.75 C	1W19753FA22	1W19754FA3	1W24264FA3	.80 C
W-2293	3.00 C	1W13083FE27	5.80 C	1W19754FA3	1.40 C	1W24265FA2	2.20 C
W-2319FE11	1.00 C	1W13210FA3	1.70 C	1W19764FA22	1.50 C	1W24268FA1	2.25 C
W-2502FA3	8.00 C	1W13212FA3	1.85 C	1W19779	1W19779FA3	1W24514FA2	3.50 C
W-2508FA3	1.75 C	1W13657FA9	3.80 C	1W19779FA3	.05	1W24515FA3	.75 C
W-2509FA39	.05	1W13976FA15	5.50 C	1W19780FA3	3.50 C	1W24515FA22	1.45 C
W-2509-1FA39	.05	1W13987FA3	3.60 C	1W19784FA22	2.95 C	1W24516FA2	3.60 C
W-2510-1	.06	1W14134FA7	1.90 C	1W19785FA22	1W19787FA22	1W24516FA22	1W24516FA2
W-2515	3.70 C	1W14318FA8	3.00 C	1W19787FA22	5.60 C	1W24518FA2	2.10 C
W-2523FA3	.08	1W14460FA44	1.90 C	1W19788FA3	4.60 C	1W24519FA3	1.00 C
W-2524	.40	1W14518FA22	2.00 C	1W19793FA3	2.70 C	1W24520FA1	.06
W-2531	.15	1W14540FA2	2.50 C	1W19802FA15	1.50 C	1W24522FA1	2.60 C
W-2537-3	.02	1W14546FA2	3.70 C	1W19828FA3	3.35 C	1W24524FA3	3.00 C
W-2537-5FA3	1.30 C	1W14657FA22	.02	1W19807FA3	2.00 C	1W24736FA9	3.40 C
W-2543FE7	7.00 C	1W14682FA7	1.80 C	1W19978FA3	2.25 C	1W24736FA22	3.70 C
1W10002FA3	.01	1W14728FA3	3.50 C	1W19982FA3	2.50 C	1W24749FA9	1.35 C
1W10024FA3	3.50 C	1W14764FA1	3.90 C	1W19982FA22	2.00 C	1W24755FA3	.85 C
1W10084	1.50 C	1W15471FA9	2.80 C	1W19986FA3	1.75 C	1W24756	1.75 C
1W10101FA3	1.70 C	1W15474FJ40	5.00 C	1W19986FA14	.80 C	1W24756FA3	1.75 C
1W10244FA3	2.90 C	1W16111FA1	.08	1W19988FA2	.95 C	1W24778	2.00 C
1W10262FA22	.80 C	1W16117FA3	8.00 C	1W19988FA3	1.75 C	1W24818FA2	.05
1W10393FA3	.70 C	1W16154FE15	.10	1W19988FA14	1.50 C	1W24819FA3	5.50 C
1W10426FA3	.50 C	1W16167FA3	.07	1W19990FA3	3.20 C	1W24894FE11	1.00 C
1W10456FA26	1W10271FA26	1W16198FA2	.10	1W19990FA22	1.65 C	1W24895FA2	2.60 C
1W10583FA3	.50 C	1W16917FA3	9.50 C	1W19991FA3	1.25 C	1W24896FA2	2.90 C
1W10611FA3	3.10 C	1W17323FA3	1.60 C	1W19992FA3	1.90 C	1W24903FE11	1.25 C
1W10613FA3	.60 C	1W17325FA3	9.00 C	1W19994FA3	2.75 C	1W24934FE15	1.60 C
1W10614FA3	1.40 C	1W17326FA22	.15	1W19996FA3	5.00 C	1W24935	1.50 C
1W10618FA3	1.60 C	1W17327FA5	1W17326FA22	1W19996FA14	2.10 C	1W25036FA9	1.50 C
1W10621FA3	1.50 C	1W17331FA4	.12	1W19998FA3	9.50 C	1W25037FE9	2.00 C
1W10621FA14	1.45 C	1W17729FA33	9.00 C	1W20248FA3	.70 C	1W25182FA9	2.00 C
1W10632FA2	.80 C	1W18004FA3	.05	1W20250FA3	2.50 C	1W25200FA3	2.20 C
1W10632FA22	.80 C	1W18035	6.00 C	1W20256FA22	2.80 C	1W25201	1.75 C
1W10633FA3	.90 C	1W18204FA3	2.85 C	1W20508FA3	1.10 C	1W25223	2.50 C
1W10634FA22	.90 C	1W18257FA22	1.20 C	1W20519FA22	2.90 C	1W25327FE11	1.75 C
1W10635FA22	1.40 C	1W18293FA22	2.00 C	1W20752FA2	1.70 C	1W25328FA2	.90 C
1W10636FA3	1.50 C	1W18296FA22	2.00 C	1W20755FA3	.05	1W25328FE11	1.00 C
1W10638FA4	2.90 C	1W18359FA22	1.10 C	1W21019FA3	.10	1W25328FA9	3.00 C
1W10639FA3	1W10618FA3	1W18371FA3	4.20 C	1W21291FA3	3.50 C	1W25336FA3	1.60 C
1W10639FA14	1.25 C	1W18378FA3	1.80 C	1W21293FA3	.18 C	1W25344FE11	1.60 C
1W10644FA3	2.50 C	1W18436FA22	1.20 C	1W21295FA3	.50 C	1W25345FE11	2.00 C
1W10660FA22	4.00 C	1W18439FA22	1.20 C	1W21539FA3	1W19996FA3	1W25348FA3	2.00 C
1W10677FA3	2.10 C	1W18451FA22	1W19447FA3	1W21813FA3	1.10 C	1W25349FA3	2.00 C
1W10796FA9	1.30 C	1W18673FA3	3.00 C	1W22285FA9	3.25 C	1W25368FA3	1.75 C
1W10817FA3	1.00 C	1W18679FA9	1.60 C	1W22389FA3	4.00 C	1W25368FE11	1.60 C
1W10857FA7	4.00 C	1W18766FA1	4.35 C	1W22401FA2	3.90 C	1W25369FE11	1.80 C

* Recommended substitute.

ALL PRICES SUBJECT TO CHANGE WITHOUT NOTICE

RADIO PARTS PRICE LIST—Continued

PART NUMBER	LIST PRICE or Substitute	PART NUMBER	LIST PRICE or Substitute	PART NUMBER	LIST PRICE or Substitute	PART NUMBER	LIST PRICE or Substitute
1W25372FA3	.01	1W45646FA22	1W14546FA2	1W57223FA1	3.85 C	2W19996FA43	7.00 C
1W25476FA8	1W25476FA9	1W45792FA2	.13	1W59493	.05	2W20506FA1	.04
1W25476FA9	1.75 C	1W45801FA3	1W19998FA3	1W59841FA3	8.30 C	2W21015FA22	.05
1W25492FA9	2.50 C	1W47640FA3	1.50 C	1W59842FA22	.05	2W23722FA8	3.50 C
1W25495FA21	5.00 C	1W47664	1W47640FA3	1W59859FA3	.10	2W23723FA7	2.80 C
1W25644FA2	2.50 C	1W48158FA3	1.35 C	1W60053FJ45	2.50 C	2W23736FA8	.12
1W25759FE7	.05	1W48188FA3	1.70 C	1W60083FE7	9.50 C	2W252328FA9	2.75 C
1W25843FA3	.15	1W51931	1.50 C	1W60177FJ45	1.00 C	2W25331FA43	2.50
1W25848FE7	2.50 C	1W52005FA3	1.50 C	1W60211FE7	1.60 C	2W25342FA3	8.25 C
1W25855FA3	.15	1W52020FA3	1.25 C	1W60405FJ45	.05	2W25468FE26	2.20 C
1W25872	.10	1W52066FA3	2.00 C	1W60447FJ45	9.00 C	2W25494FA8	2.50 C
1W27260FE15	8.30 C	1W52100	1W52118FA3	1W60971FE7	7.00 C	2W25495FC91	4.25 C
1W27714FE7	.15	1W52114FA2	3.50 C	1W60977FE7	.07	2W35685FA3	1.00 C
1W27716FA2	3.50 C	1W52118FA3	.80 C	1W60980FE5	6.50 C	2W35702	.60 C
1W27748FA3	.09	1W52132FA3	1.25 C	1W60981FE7	.10	2W35731	2.90 C
1W29058FA3	1.25 C	1W52148FA14	1.00 C			2W36547FA7	1.20 C
1W29061FA3	1.50 C	1W52156FA3	1.50 C	2W10245FA7	3.00 C	2W36580FA5	1.00 C
1W29084FA3	.90 C	1W52219FA3	.90 C	2W10266FA7	1.00 C	2W36674FA7	3.00 C
1W29091FA3	1.50 C	1W52220FA22	2.00 C	2W10286FA7	2.80 C	2W36716FA7	2.50 C
1W29094FA3	.12	1W52221FA3	1.70 C	2W10395FA8	1.50 C	2W44124FA3	.90 C
1W29126FA3	.04	1W52210FA22	.70 C	2W10610FA7	1.25	2W51909	1.50 C
1W29155FA3	2.00 C	1W52223FA22	1.50 C	2W10611	1.80 C	2W52219FA7	1.40 C
1W29158FA3	3.00 C	1W52224FA3	2.50 C	2W10612FA3	2W10610FA7	2W52321FA3	.05
1W29184FA3	2.10 C	1W52225FA22	1.50 C	2W10625FA43	8.50 C	2W52505FA1	2.50 C
1W29311FA33	6.25 C	1W52327FA2	.60 C	2W10632FA7	1.60 C	2453954	.50 C
1W29750FA3	3.75 C	1W52343FA3	.90 C	2W10633FA7	2.75 C	2W53996FA43	2.00 C
1W29752FA3	2.40 C	1W52353FA14	1.50 C	2W10634FA7	1.40 C	2W54094	1.20 C
1W29758FA3	2.75 C	1W52321FA1	2.50 C	2W10817FA7	1.50 C	2W54515FA43	2.00 C
1W29784FA5	1.35 C	1W52346FA3	1.50 C	2W10912FA7	1.20 C	2W54532FA22	2.20 C
1W29791FA3	1.65 C	1W52353FA3	2.00 C	2W10914FA7	2.40 C	1W54686FA43	2.00 C
1W29816FA15	.02	1W52392FA2	.05	2W10915	5.00 C	2W59868FA43	.20
1W29818FA5	3.50 C	1W52392FA22	.10	2W10918FA7	1.65 C		
1W29824FA5	1.50 C	1W52420FA3	3.00 C	2W10932FA7	1.80 C	3W21020FA52	.10
1W30963	.16	1W52427FA3	1.70 C	2W10932FA8	4.10 C	3W35045	†
1W31704FA3	1.60 C	1W52443FA3	1W52457FA3	2W10933FA8	3.00 C	3W36640	1.00 C
1W31736FA3	1.40 C	1W52457FA3	2.00 C	2W10933FA54	4.00 C	3W38942	2.25 C
1W32042FA3	3.75 C	1W52505FA3	.50 C	2W10934FA7	1.00 C	3W42481FA3	1.50 C
1W32228FA3	1.80 C	1W52507FA22	1.10 C	2W10934FA54	1.50 C	3W54230	.200 C
1W32229FA22	2.00 C	1W52516FA3	1.50 C	2W10935FA7	1.85 C	3W54598FA22	†
1W32403FA1	1.00 C	1W52517FA3	4.30 C	2W10936FA7	1.50 C	3W54666FE19	.40 C
1W32467FA3	3.00 C	1W52538FA3	2.75 C	2W10937FA8	4.30 C	3W54968FA52	6.60 C
1W32694FA3	1.85 C	1W52539FA3	.90 C	2W10940FA7	2.70 C		
1W35032FE7	1.00 C	1W52540FA3	1.60 C	2W10957FA7	2.80 C	4W10934FA7	6.00 C
1W35033FA1	1.00 C	1W52561FA3	1.20 C	2W11511FA7	3.00 C	4W15088FA7	2.00 C
1W35034FA3	1.90 C	1W52620FA14	.75 C	2W11515FA7	2.00 C	4W19090FA7	2.00 C
1W35045FA3	.30 C	1W52627	2.00 C	2W11519FA7	5.00 C	4W19102FA7	2.00 C
1W35046FA1	1.65 C	1W52694FA3	1.00 C	2W11696FA7	2W11511FA7	4W24256FA43	1.20 C
1W35046FA3	1W35046FA22	1W52695	4.50 C	2W11855FA7	3.50 C	4W24257FA43	2.00 C
1W35046FA22	.64 C	1W52696FA3	.14	2W12063FA8	1W12063FA2	4W24260FA43	6.00 C
1W35047FA22	.30 C	1W52793	1.80 C	2W12067FA8	3.75 C	4W35046FA1	1.65 C
1W35049FA1	1.00 C	1W52799	5.50 C	2W12180FA3	2.00 C	4W35049FA43	4.00 C
1W35049FA22	.70 C	1W52987FA3	3.10 C	2W12180FA7	2.35 C	4W56293	2.50 C
1W35087FA7	.30 C	1W55950FA9	3.50 C	2W12186FA7	4.00 C	4W56294	1.60 C
1W35875	3.50 C	1W56106FA3	2.80 C	2W12189GA7	1W11888FA3	5W2017	1.00 C
1W35945	4.00 C	1W56289FA3	5.00 C	2W12566	.10	7W54598FA5	*8641-28
1W35951FA3	6.80 C	1W56306FE15	4.40 C	2W12631FA43	1.90 C		
1W36446FA30	.55 C	1W56581FA3	5.00 C	2W12637FA43	2.80 C	8W54820	.05
1W36521FA3	1.50 C	1W56637FA3	6.50 C	2W14682FA7	3.50 C	9W10328	.08
1W36533	1.80 C	1W56637FE11	1W56637FA3	2W14703FA3	2.80 C	9W10330	.10
1W36577FA3	.65 C	1W56643FA3	6.00 C	2W14705FA7	2.80 C	9W10635	2.80 C
1W36636FA5	1.60 C	1W56644FA3	6.00 C	2W14711FA7	5.20 C	9W10817	4.70 C
1W36670FA3	1.65 C	1W56674FA33	.10	2W15748FA8	.09	9W10933	5.25 C
1W36671FA3	1.25 C	1W56675	.10	2W15835FA8	8.50 C	9W10934	6.00 C
1W36672FA5	1.25 C	1W56681	7.50 C	2W16111FA7	.15	9W10936	*9W10939
1W36675FA5	1.00 C	1W56885FE7	1.50 C	2W16113FA7	.15	9W10937	4.30 C
1W36677FA5	1.00 C	1W56908FA22	1.90 C	2W16115FA7	*9W10328	9W10939	2.70 C
1W36716FA5	1.90 C	1W56910FE11	1.45 C	2W17743FC88	9.80 C	9W10991	8.75 C
1W37630FA9	18.50 C	1W56912FA4	2.30 C	2W17753FA43	.08	9W13594	.10
1W37633FA9	3.90 C	1W56913FA3	1.00 C	2W19408FA7	1.90 C	9W13965	.07
1W37654FA3	3.90 C	1W56918FJ45	2.20 C	2W19434FA7	3.50 C	9W14149	.05
1W42273FA22	4.00 C	1W56919FE7	1.70 C	2W19590FA7	3.10 C	9W14150	.10
1W42303FA9	2.50 C	1W56920FE7	1.60 C	2W19592FA7	1W19592FA22	9W14153	6.75 C
1W42361	.20 C	1W56926FA2	3.00 C	2W19595FA7	2.50 C	9W14157	.05
1W42535FA3	1.25 C	1W56960FA22	3.40 C	2W19986FA7	.70 C	9W14311	.12
1W42536FA3	.65 C	1W56999FJ	5.40 C	2W19986FA43	1.60 C	9W14518	.07
1W42537FA3	1.50 C	1W57117FE7	3.70 C	2W19988FA43	2.00 C	9W14703	.06
1W42706FA1	1.10 C	1W57146FA1	3.75 C	2W19991FA1	.05	9W14704	6.10 C
1W44148	.60 C	1W57214FA3	.02	2W19991FA7	4.30 C	9W14705	.10
1W44443	1.85 C	1W57215FA3	2.00 C	2W19992	3.60 C	9W14707	.15
1W44709FA3	2.40 C	1W57216FA3	2.50 C	2W19994FA43	.03	9W14711	.10

* Recommended substitute.
† Refer to distributor.

ALL PRICES SUBJECT TO CHANGE WITHOUT NOTICE

RADIO PARTS PRICE LIST—Concluded

PART NUMBER	LIST PRICE or Substitute	PART NUMBER	LIST PRICE or Substitute	PART NUMBER	LIST PRICE or Substitute	PART NUMBER	LIST PRICE or Substitute
9W14766	.15	9W22856	.10	9W57337	.05	12W45661	7.80 C
9W15392	5.75 C	9W23245	.05	9W57339	*8639.42	12W45662	.10
9W15471	9.00 C	9W23325	*9W23326	9W57354	*9W57334	12W45663	7.80 C
9W15837	.10	9W23326	.07	9W57803	.15	12W45666	7.75 C
9W15839	.15	9W23329	.10	9W60439	1.10 C	12W45672	8.90 C
9W15844	7.60 C	9W23331	.20			12W45673	9.35 C
9W18596	3.20 C	9W23375	4.00 C	11W29739	.05	12W45685	*12W29939
9W18610	5.30 C	9W23377	.10	11W29740	.06	12W45688	12.60 C
9W19081	*8639.18	9W23402	.10	11W29741	5.70 C	12W45689	.10
9W19086	2.80 C	9W23403	8.10 C	11W29743FA3	.03	12W45711	.15
9W19087	3.20 C	9W23404	.10	11W46211	.05	12W45714	.10
9W19094	2.50 C	9W23405	.10	11W52489	3.40 C	12W45715	16.75 C
9W19248	2.75 C	9W23416	.20	11W52604	2.00 C	12W45733	18.30 C
9W19353	.05	9W35029	1.70 C			12W45735	.18
9W19580	5.00 C	9W36675	4.60 C	12W29900	.05	12W59364	.10
9W19590	2.90 C	9W42302	2.60 C	12W29902	4.70 C		
9W19591	1W1-9592	9W51902	4.60 C	12W45646	4.35 C	19W17753	.15
9W19592	1.75 C	9W52113	2.90 C	12W45647	4.80 C	19W20256	12.50 C
9W19593	3.50 C	9W52203	5.80 C	12W45648	.10	19W23753	.30
9W19988	1.00 C	9W52328	4.30 C	12W45649	4.80 C	19W59842	.10
9W20519	1.20 C	9W52629	5.40 C	12W45654	5.90 C	19W59844	.15
9W22469	7.00 C	9W52693	5.25 C	12W45655	6.30 C	19W59849	.20
9W22522	2.00 C	9W56919	3.00 C	12W45657	6.30 C		
9W22721	.10	9W56990	.08	12W45659	.06		
9W22850	.10	9W57334	.06	12W45660	.05	K02-1001-1	†

* Recommended substitute.

† Refer to distributor.

ALL PRICES SUBJECT TO CHANGE WITHOUT NOTICE

REFRIGERATION PARTS PRICE LIST

PART NUMBER	LIST PRICE or Substitute	PART NUMBER	LIST PRICE or Substitute	PART NUMBER	LIST PRICE or Substitute	PART NUMBER	LIST PRICE or Substitute
61-194	8.00 C	5301-3	.40	5517-25	.50	5533-2	.20
63-18	.20	5303-4	.40	5517-26	.50	5535-1	1.50
63-19	.20	5303-7	.40	5518-1	4.50 C	5535-2	1EA 5536-2
63-22	6.00 C	5303-8	.40	5518-3	.20	1EA	65-1
63-26	.20	5303-12	.50	5518-4	.30	5536-1	.30
63-28	6.00 C	5305-1	1.60	5518-5	.30	5536-2	.40
63-37	6.00 C	5305-2	.80	5518-6	.40	5536-3	.15
63-44	.15	5306-1	.14	5518-48	*5518-48	5538-2	1.50
63-50	.15	5306-2	7.50 C	5519-2	.20	5538-3	.60
63-67	1.90	5307-1	7.50 C	5519-3	4.50 C	5538-4	.40
63-68	1.50	5350-1	22.00	5519-6	.15	5538-5	.40
63-69	2.40	5350-2	22.00	5520-14	*5520-8	5538-7	.40
63-154	.50	5350-3	2.30	5521-7	1.80	5538-8	*5538-7
63-155	.50	5350-14	20.00	5524-1	.18	5538-10	*6269-1
63-156	.50	5350-22	*5550-25	5524-2	.40	5538-11	1.00
64-6	2.60	5350-25	20.00	5524-4	.30	5538-12	.30
601-10	.40	5350-26	18.00	5525-5	1.20	5540-3	15.00
C-117	7.00	5350-27	20.00	5525-6	*5525-20	5540-4	15.00
C-124	7.00	5350-28	19.00	5525-7	2.50	5450-5	15.00
5050-1	1.50	5350-32	27.00	5525-14	1.80	5542-1	1.20
5050-6	1.80	5350-33	25.00	5525-20	1.80	5542-2	2.40
5050-8	2.10	5501-3	22.00	5527-1	2.20	5542-4	1.30
5050-10	1.50	5501-5	20.00	5528-1	.40	5542-5	1.80
5050-11	2.20	5501-7	16.00	5530-1	*5530-49	5542-6	2.20
5050-12	2.20	5501-12	25.00	5530-2	*5530-49	5542-7	1.50
5051-1	.40	5501-15	22.00	5530-3	*5530-49	5542-9	1.50
5053-3	*6269-1	5501-17	25.00	5530-4	9.00	5542-10	1.80
5055-2	5.00	5501-20	22.00	5530-5	*5530-49	5542-11	1EA 5542-26
5061-2	0.00	5514-13	2.50	5530-6	9.00	2EA	*9W22522
5062-1	.50	5514-28	5.20	5530-7	9.00	1EA	*8640-19
5072-7	.15	5514-33	*5515-32	5530-8	*5530-50	1EA	*8640-20
5072-8	.20	5514-34	4.50	5530-9	*5530-50	5542-12	.90
5074-1	.14	5514-41	4.50	5530-10	9.00	5542-14	1.70
5080-2	2.20	5514-45	4.50	5530-11	9.00	5542-16	1EA 5542-26
5095-3	1.80	5514-46	3.00	5530-12	*5530-51	2EA	*9W22522
5095-6	1.80	5514-48	10.50	5530-13	*5530-51	1EA	*8640-20
5095-7	*1SD-897	5514-49	6.00	5530-14	*5530-51	1EA	*8640-19
5095-8	1.80	5514-85	20.00	5530-15	10.00	5542-18	.40
5095-9	1.80	5515-4	1.50	5530-16	*5530-50	5542-19	.40
5095-10	1.80	5515-5	1.50	5530-17	*5530-50	5542-21	.60
5105-8	1.10	5515-6	1.80	5530-18	*5530-51	5542-22	2.40
5106-32	.50	5515-16	4.00	5530-19	*5530-51	5542-23	1.80
5106-36	*5559-27	5515-15	3.00	5530-20	*5530-51	5542-24	3.80
5106-37	.60	5515-16	3.00	5530-21	*5530-51	5542-25	2.80
5106-38	.30	5515-21	2.20	5530-22	*5530-52	5542-26	2.20
5142-1	1.50 C	5515-31	*5515-32	5530-23	*5530-52	5542-28	1.20
5170-1	.40	5515-32	*5515-36	5530-24	*5530-51	5542-29	1.30
5173-1	.15	5515-36	6.00	5530-27	*5530-51	5543-4	.15
5190-1	6.30	5515-37	3.30	5530-28	*5530-53	5543-9	.15
5190-2	5.00	5515-38	2.70	5530-29	10.00	5543-15	.40
5192-1	3.70	5515-39	2.70	5530-32	*5530-48	5544-1	.30
5192-2	3.70	5515-45	*5515-48	5530-33	9.00	5549-1	.60
5195-1	*5195-16	5515-46	*5515-48	5530-34	*5530-48	5554-1	1.80
5195-2	*5195-19	5515-47	3.60	5530-35	9.00	5555-13	.26
5195-5	*5195-15	5515-48	3.50	5530-37	8.00	5555-24	5.00
5195-6	*5195-18	5515-51	2.80	5530-41	14.00	5555-45	1.50
5195-7	*5195-17	5515-55	3.20	5530-42	7.00	5555-46	1.60
5195-9	*5195-25	5515-59	4.00	5530-44	12.40	5557-1	7.50 C
5195-13	4.00	5515-62	7.00	5530-45	16.00	5559-7	1.80
5195-14	4.50	5515-63	9.00	5530-46	9.00	5559-13	2.50
5195-15	4.50	5515-64	8.30	5530-47	9.00	5559-17	3.00
5195-16	4.50	5515-66	8.30	5530-48	12.00	5559-22	2.50
5195-17	4.00	5515-67	6.50	5530-49	20.00	5559-27	3.30
5195-18	4.00	5516-10	.90	5530-50	14.00	5559-28	*5559-31
5195-19	4.00	5516-11	1.50	5530-51	14.00	5559-31	2.80
5195-20	4.00	5516-12	1.40	5530-52	14.00	5559-32	3.70
5195-21	4.00	5516-18	1.10	5530-53	12.00	5559-36	30.00
5195-22	*5195-13	5516-21	1.80	5530-54	8.00	5559-37	3.70
5195-25	4.50	5516-22	1.60	5530-55	*5530-54	5559-39	3.00
5195-28	4.50	5516-23	1.90	5530-56	7.00	5559-42	3.00
5195-32	5.50	5516-25	1.70	5530-57	*5530-56	5560-5	.30
5196-1	.70	5516-26	1.60	5530-59	5.70	5560-6	1.10
5198-4	4.00	5516-27	1.20	5530-60	8.00	5563-12	.30
5198-6	2.80	5516-29	1.70	5530-61	8.50	5563-17	.60
		5517-1	.50	5530-62	7.00	5564-1	.15
		5517-4	.18	5530-69	8.00	5565-1	2.50
		5517-7	.40	5532-4	*5532-7	5565-9	1.50
		5517-8	.30	5532-5	1.60	5566-1	1.00
		5517-24	.50	5532-7	1.60	5566-2	1.00

* Recommended substitute.

ALL PRICES SUBJECT TO CHANGE WITHOUT NOTICE

REFRIGERATION PARTS PRICE LIST—Continued

PART NUMBER	LIST PRICE or Substitute	PART NUMBER	LIST PRICE or Substitute	PART NUMBER	LIST PRICE or Substitute	PART NUMBER	LIST PRICE or Substitute
5566-3	*5566-1	5597-14	.30	5656-23	8.00	6001-102	45.00
5566-6	.70	5597-15	1.20	5656-24	6.00	6001-103	40.00
5570-5	.20	5597-16	.80	5656-26	5.20	6002-6	*6012-51
5570-19	*5570-44	5597-17	1.00	5656-27	4.30	6002-7	*6012-49
5570-22	.40	5598-2	.90	5656-28	5.00	6002-8	*6012-50
5570-23	.40	5598-3	1.00	5656-29	*5656-32	6002-9	*6012-54
5570-24	.20	5598-8	1.10	5656-30	8.00	6002-10	*6012-55
5570-25	.20	5598-9	1.10	5656-31	*5656-33	6002-11	*6012-56
5570-32	.20	5599-1	.20	5656-32	5.00	6002-12	*6012-58
5570-35	.15	5599-4	.20	5656-33	5.00	6002-15	*6012-61
5570-40	.50	5599-9	.60	5656-34	4.40	6003-1	35.00
5570-44	.25	5599-12	.16	5656-35	3.90	6003-3	35.00
5570-47	.12			5656-39	7.30	6005-203	2.00
5570-53	.12	5630-1	2.20	5656-40	6.80	6005-208	1.60
5572-1	3.00	5630-2	2.20	5656-41	6.80	6005-218	1.00
5572-2	3.00	5630-3	2.50	5656-42	6.30	6005-508	.50
5572-3	3.00	5632-1	2.50	5656-44	3.40	6006-26	.50
5572-6	3.00	5632-3	2.40	5656-46	7.50	6006-64	.50
5576-2	.30	5632-4	4.50	5656-47	7.20	6006-93	.40
5576-3	6.00C	5635-1	.90	5656-48	7.50	6006-96	.40
5577-2	2.20	5635-3	1.20	5656-49	6.80	6007-1	2.40
5578-2	*5517-24	5635-4	1.20	5656-50	6.50	6007-2	2.10
5578-3	*5517-25	5635-8	1.20	5656-51	7.00	6007-6	*6007-7
5578-4	*5517-26	5635-14	.90	5656-52	6.50	6007-7	2.50
5579-5	*5515-32	5635-16	1.00	5691-2	2.60	6007-22	*6007-28
5580-19	*5580-20	5635-17	1.00	5691-3	1.80	6007-23	*6007-28
5580-20	.30	5635-18	1.00	5691-4	2.50	6007-26	*6007-28
5581-1	6.00C	5635-19	*5636-45	5691-5	3.00	6007-27	*6007-28
5584-5	4.60	5635-20	1.10	5691-6	2.00	6007-28	2.50
5584-6	4.60	5635-28	1.00	5691-9	4.20	6007-31	2.50
5586-5	1.50	5635-36	3.70	5691-10	4.20	6007-40	3.50
5586-6	1.90	5636-7	.20	5691-11	4.60	6007-43	6.00
5586-8	1.30	5636-8	.40	5691-12	4.60	6007-44	*6007-40
5586-9	2.00	5636-9	.40	5691-13	3.50	6007-45	5.00
5586-10	.70	5636-10	.60	5692-3	1.00	6007-46	1.80
5586-14	4.50	5636-11	.75	5692-8	.40	6007-48	1.20
5586-15	1.60	5636-15	.40	5692-9	.60	6007-67	*6007-1
5586-16	2.20	5636-18	.46	5692-12	.70	6007-78	*6007-90
5586-17	*5586-20	5636-21	.20	5692-13	.70	6007-79	3.00
5586-20	4.50	5636-22	.40	5692-16	.70	6007-81	7.50
5586-21	5.00	5626-23	.56	5692-18	.30	6007-83	6.50
5587-1	.80	5636-24	.80	5692-20	.40	6007-84	6.20
5587-5	*5587-29	5636-28	.50	5692-21	.30	6007-85	*6007-90
5587-6	3.30	5636-41	.50	5692-22	.30	6007-88	5.50
5587-7	3.30	5636-46	.40	5692-23	2.00	6007-89	3.20
5587-8	1.20	5636-47	.20	5692-24	.18	6007-90	4.00
5587-12	1.30	5636-49	.20	5692-30	3.00	6007-91	5.00
5587-13	.12	5636-66	.80	5692-31	3.00	6007-92	6.00
5587-16	*5587-37	5636-67	.80	5692-32	2.50	6008-14	.90
5587-18	*5587-36	5636-74	.90	5692-33	2.50	6008-32	1.30
5587-23	*5587-29	5636-75	.90	5692-34	2.50	6008-33	1.30
5587-24	*5587-30	5636-76	*5636-95	5692-35	2.40	6008-37	.60
5587-28	1.30	5636-77	*5636-95	5692-37	.40	6008-42	.90
5587-29	1.20	5636-81	.90	5692-38	3.75	6008-43	1.00
5587-30	.96	5636-82	.90	5692-40	2.40	6008-46	1.90
5587-31	1.60	5636-89	.60	5692-41	2.40	6008-47	1.50
5587-33	4.00C	5636-90	.50	5692-44	1.40	6008-48	1.20
5587-36	2.50	5636-95	2.40	5692-45	1.40	6012-17	*6012-54
5587-37	3.00	5636-104	4.60	5692-46	2.00	6012-20	13.00
5587-38	1.80	5636-107	4.30	5692-47	2.00	6012-32	13.00
5588-1	*5588-8	5641-5	3.50	5692-48	.60	6012-34	13.00
5588-2	1.10	5641-6	3.50			6012-35	13.50
5588-3	1.50	5641-7	5.00	6001-59	35.00	6012-44	16.00
5588-4	1.50	5641-8	3.00	6001-61	40.00	6012-48	11.00
5588-5	3.50	5641-11	1.00	6001-71	35.00	6012-49	10.50
5588-6	1.20	5641-13	1.40	6001-72	35.00	6012-50	11.00
5588-7	1.00	5645-15	.12	6001-73	35.00	6012-51	11.50
5588-8	.80	5645-38	.40	6001-74	50.00	6012-54	11.00
5588-9	.80	5645-41	.40	6001-84	29.20	6012-55	13.00
5588-10	5.00	5649-1	1.80	6001-85	36.00	6012-56	13.50
5588-11	5.00	5656-8	5.60	6001-86	35.00	6012-57	7.50
5595-7	7.50C	5656-11	7.00	6001-87	25.00	6012-58	11.00
5595-13	7.50C	5656-12	6.00	6001-88	32.00	6012-61	11.00
5595-14	7.50C	5656-16	6.00	6001-89	60.00	6012-62	11.00
5595-23	5.00C	5656-17	5.00	6001-90	32.00	6012-63	9.00
5595-24	.20	5656-18	*5656-21	6001-91	35.00	6012-68	*6012-87
5595-29	7.50C	5656-19	3.60	6001-93	19.00	6012-70	14.00
5595-31	.10	5656-20	5.00	6001-98	40.00	6012-72	17.00
5597-6	.50	5656-21	5.50	6001-99	30.00	6012-73	14.00
5597-8	*5597-6			6001-101	45.00	6012-74	11.50

* Recommended substitute.

ALL PRICES SUBJECT TO CHANGE WITHOUT NOTICE

REFRIGERATION PARTS PRICE LIST—Continued

PART NUMBER	LIST PRICE or Substitute	PART NUMBER	LIST PRICE or Substitute	PART NUMBER	LIST PRICE or Substitute	PART NUMBER	LIST PRICE or Substitute
6012-78	12.50	6025-80	4.50	6031-31	.12	6045-2	.22
6012-80	17.00	6025-81	3.50	6032-1	.04	6045-4	.35
6012-81	22.00	6025-84	3.50	6035-10	*6335-10	6046-1	.40
6012-84	12.00	6026-24	3.30	6035-16	.30	6046-3	.74
6012-85	22.00	6026-26	3.30	6035-18	.36	6046-4	.90
6012-86	16.00	6026-35	8.50	6035-41	.36	6046-6	.44
6012-87	14.00	6026-36	9.00	6035-71	.50	6048-5	.44
6012-89	19.00	6026-37	8.50	6035-101	.60	6048-13	.14
6012-90	22.00	6026-38	9.50	6035-105	.30	6048-14	7.50 C
6012-91	22.00	6026-41	14.00	6035-107	.70	6048-21	.12
6016-13	9.50	6027-2	2.00	6035-108	.70	6048-25	.12
6016-14	9.50	6027-6	2.00	6035-118	2.00	6048-30	.18
6017-21	7.80	6027-7	2.00	6035-119	2.00	6048-32	.14
6017-25	9.00	6027-9	2.00	6035-128	.70	6048-33	.14
6017-26	8.00	6027-14	1.30	6035-138	.60	6048-36	.36
6017-27	8.00	6027-15	1.10	6035-139	.60	6048-37	.18
6017-31	9.00	6027-16	1.10	6035-140	2.50	6048-54	.06
6017-34	*6017-31	6027-25	1.20	6035-141	1.60	6048-59	.08
6017-37	10.00	6027-26	3.00	6035-142	2.60	6048-64	.30
6017-38	10.00	6027-29	4.50	6035-146	1.80	6050-2	2.70
6017-39	8.00	6027-31	2.20	6035-150	.60	6050-6	7.50
6017-41	4.50	6027-34	2.20	6035-151	.60	6050-7	7.50
6017-42	7.50	6027-35	2.40	6035-152	1.70	6050-10	7.50
6017-46	9.50	6027-36	1.50	6035-153	2.80	6050-11	7.50
6017-47	10.00	6027-43	4.20	6035-154	1.20	6050-13	*6050-10
6022-23	13.00	6027-44	4.60	6035-156	.30	6051-5	1.50
6022-24	20.00	6027-45	2.00	6035-157	2.80	6051-6	*6051-14
6022-25	12.00	6027-46	2.70	6035-159	1.30	6051-8	*8040-56
6022-26	9.70	6027-51	2.40	6035-160	1.10	6051-11	1.30
6022-27	11.00	6027-52	10.00	6035-153	.30	6051-13	2.10
6022-32	10.00	6027-55	4.30	6035-164	1.50	6051-14	2.60
6022-33	10.00	6027-67	2.40	6035-170	1.00	6051-16	16.00
6022-34	*6022-39	6029-1	1.90	6035-174	2.40	6051-17	2.50
6022-38	6.30	6029-19	2.60	6035-175	2.40	6051-18	2.50
6022-39	8.00	6029-21	2.00	6035-185	.40	6051-19	*6051-17
6023-30	3.10	6029-23	2.60	6035-186	.40	6051-20	3.50
6023-32	2.40	6029-24	2.00	6037-1	.16	6053-1	.60
6024-4	1.50	6029-27	3.70	6037-4	6.00 C	6054-1	.22
6024-5	2.20	6029-29	2.60	6037-6	6.00 C	6055-3	.30
6024-6	2.20	6029-31	*6025-60	6037-11	8.00 C	6055-6	.60
6024-10	1.50	6029-33	2.20	6037-14	8.00 C	6055-7	.30
6024-11	2.20	6029-35	2.20	6037-15	8.00 C	6055-8	.90
6024-12	2.20	6029-36	1.80	6037-17	.10	6055-9	.30
6024-13	2.20	6029-38	5.20	6037-19	8.00 C	6055-11	7.50 C
6024-14	2.20	6029-39	4.90	6037-23	4.50 C	6055-12	.30
6024-15	2.20	6029-42	1.80	6037-24	8.00 C	6055-13	7.50 C
6024-16	2.20	6029-43	2.20	6037-25	8.00 C	6055-15	.60
6024-17	2.20	6029-51	3.10	6037-29	4.50 C	6055-19	.90
6024-18	4.00	6029-52	3.50	6037-31	8.00 C	6055-20	.14
6024-25	6.00	6029-53	4.50	6037-32	.15	6055-21	.16
6024-29	6.50	6029-54	7.00	6037-34	8.00 C	6055-22	.44
6024-33	3.90	6029-56	3.80	6037-35	.10	6055-24	.30
6024-34	5.40	6030-1	*6030-15	6037-38	.12	6055-26	.96
6024-35	6.00	6030-7	2.20	6037-49	8.60 C	6055-28	8.00 C
6024-36	3.90	6030-8	4.00	6037-50	8.00 C	6055-29	.80
6024-37	5.50	6030-10	*6030-8	6037-51	.12	6055-31	.12
6024-38	6.00	6030-15	3.00	6037-52	.04	6055-33	.12
6024-39	2.60	6030-19	1.80	6037-53	3.00 C	6055-34	.12
6024-40	4.00	6030-21	3.00	6037-54	.04	6055-35	1.20
6024-41	4.20	6030-22	5.50	6037-55	6.00 C	6055-36	.30
6025-17	2.40	6030-23	2.80	6039-1	4.50 C	6055-37	.12
6025-21	2.40	6031-2	*6031-21	6040-1	3.30	6055-43	4.50
6025-23	2.00	6031-3	*6031-21	6040-12	1.90	6055-44	1.00
6025-26	2.00	6031-4	*6031-21	6040-13	*6040-27	6055-47	*6055-29
6025-28	2.20	6031-6	.24	6040-15	2.20	6055-51	.30
6025-29	2.50	6031-10	5.00 C	6040-16	2.20	6055-53	.80
6025-32	2.20	6031-11	.30	6040-17	1.90	6055-54	.14
6025-37	1.80	6031-12	.30	6040-18	1.90	6055-55	.20
6025-37C	*6025-37	6031-13	.15	6040-20	4.00	6056-1	.22
6025-38	1.80	6031-15	.60	6040-22	.74	6058-1	.25
6025-41	3.50	6031-16	*6031-21	6040-24	1.00	6058-4	1.00
6025-45	*6025-60	6031-17	*6031-10	6040-25	4.50	6058-7	.50
6025-46	1.80	6031-18	*6031-10	6040-26	4.50	6058-11	1.20
6025-55	6.00	6031-19	.44	6040-27	1.50	6058-14	.70
6025-56	9.00	6031-20	.08	6040-28	1.50	6058-15	.30
6025-57	5.00	6031-21	.14	6042-1	3.50	6058-16	.90
6025-59	3.00	6031-26	.06	6043-31	.90	6058-18	.60
6025-60	4.20	6031-27	.06	6043-35	*6269-1	6058-19	1.00
6025-63	10.00	6031-29	.12	6045-1	.50	6058-20	.90

* Recommended substitute.

ALL PRICES SUBJECT TO CHANGE WITHOUT NOTICE

REFRIGERATION PARTS PRICE LIST—Continued

PART NUMBER	LIST PRICE or Substitute	PART NUMBER	LIST PRICE or Substitute	PART NUMBER	LIST PRICE or Substitute	PART NUMBER	LIST PRICE or Substitute
6058-21	.40	6069-28	6.00 C	6085-18	3.20	6129-10	4.50
6059-1	.74	6069-34	4.50 C	6085-20	3.50	6129-12	4.00
6059-2	.74	6069-36	.30	6088-67	*6083-67	6129-14	5.20
6059-5	.30	6069-38	.22	6090-1	3.00	6129-17	4.00
6059-6	.30	6069-41	.14	6093-9	1.00	6131-1	*6131-40
6059-11	.74	6069-50	.04	6096-1	.22	6131-2	3.70
6059-12	.50	6069-52	.04	6097-4	*8645-1	6131-8	4.50
6059-15	.36	6069-53	.10	6097-5	.14	6131-11	*6131-15
6061-5	3.00 C	6069-54	.10	6101-1	3.00 C	6131-12	3.70
6061-6	3.00 C	6069-59	5.00 C	6103-1	1.90	6131-13	6.00
6061-7	3.00 C	6069-70	.16	6104-4	4.50	6131-15	3.70
6061-8	3.00 C	6069-77	.04	6104-5	4.50	6131-16	4.00
6061-18	.36	6080-5	2.20	6104-6	1.50	6131-24	5.00
6061-19	.36	6080-7	1.50	6105-2	.12	6131-32	3.00
6061-20	.96	6080-8	2.20	6105-3	.30	6131-33	3.00
6061-21	.96	6080-11	.74	6106-1	.36	6131-38	*6131-40
6061-22	1.20	6080-12	.90	6107-1	.44	6131-39	*6131-41
6061-24	1.00	6080-14	1.90	6107-2	.30	6131-40	3.00
6061-25	.14	6080-18	.74	6107-3	.30	6131-41	3.90
6061-32	.60	6080-19	1.00	6107-3	7.50 C	6131-42	2.40
6061-35	1.00	6080-20	2.10	6107-5	.10	6131-44	*6131-50
6061-41	2.20	6080-21	2.10	6107-6	.30	6131-45	1.80
6061-43	2.40	6080-26	.90	6107-22	3.00 C	6131-46	1.10
6061-52	1.00	6080-28	1.50	6107-31	4.00 C	6131-47	2.00
6061-54	1.00	6080-29	1.80	6112-1	.24	6131-48	1.70
6061-62	1.00	6080-31	1.50	6113-2	.90	6131-49	*6131-51
6062-2	1.10	6080-32	*5080-39	6113-3	.80	6131-50	4.50
6062-3	2.20	6080-34	.90	6117-1	7.50	6131-51	4.60
6062-4	1.50	6080-36	1.30	6117-4	7.50	6131-52	2.30
6062-6	1.50	6080-37	1.40	6117-12	16.00	6131-55	1.50
6062-7	1.10	6080-38	1.30	6117-13	20.00	6132-1	.80
6062-8	3.00	6080-39	2.20	6117-14	23.00	6132-2	.75
6062-9	1.50	6080-40	1.60	6117-15	15.00	6132-3	1.50
6062-12	2.20	6082-4	.14	6125-34	3.70	6132-4	1.50
6062-13	1.60	6082-5	.14	6125-36	3.70	6132-6	.30
6062-14	.70	6082-5	4.50 C	6126-29	1.60	6132-13	.30
6062-16	1.50	6082-11	4.50 C	6126-31	2.80	6132-14	.30
6062-17	1.50	6082-14	1.50 C	6126-32	*6126-54	6132-15	.75
6063-1	.30	6083-15	4.50 C	6126-33	*6126-55	6132-22	.30
6063-2	.36	6083-18	4.50 C	6126-34	2.40	6132-25	.36
6065-7	.60	6083-20	3.00 C	6126-36	*6126-52	6133-29	*6131-40
6065-8	.74	6083-23	4.50 C	6126-38	1.60	6133-30	*6131-41
6065-12	.50	6083-27	4.50 C	6126-50	6.00	6135-4	1.70
6065-17	.10	6083-33	2.40 C	6126-51	3.00	6137-1	.15
6065-26	.70	6083-34	3.70 C	6126-52	3.60	6137-3	.15
6065-29	.60	6083-37	.22	6126-54	2.50	6137-4	.22
6065-30	.60	6083-38	7.50 C	6126-55	2.30	6137-7	.15
6065-31	.74	6083-42	1.50 C	6126-58	*6126-66	6137-8	.15
6065-32	.60	6083-46	3.70 C	6126-59	*6126-67	6137-9	.15
6065-39	.90	6083-47	1.50 C	6126-60	*6126-68	6137-11	.30
6065-45	3.00 C	6083-48	7.50 C	6126-61	*6126-69	6137-12	.40
6065-55	.30	6083-49	3.00 C	6126-62	*6126-70	6137-16	.30
6065-58	.40	6083-50	8.00 C	6126-63	*6126-71	6137-17	.10
6067-13	3.00 C	6083-51	.05	6126-65	4.00	6137-18	1.00
6067-14	.14	6083-52	.06	6126-66	1.60	6137-21	.03
6067-15	.14	6083-53	7.50 C	6126-67	1.60	6139-13	8.00 C
6067-18	.14	6083-54	7.50 C	6126-68	1.40	6139-15	*6139-20
6067-21	.14	6083-55	1.90 C	6126-69	1.40	6139-17	.30
6067-26	.14	6083-56	3.70 C	6126-70	1.70	6139-20	.10
6067-27	1.00	6083-59	.22	6126-71	1.60	6139-22	8.00 C
6067-34	.12	6083-62	1.10 C	6127-7	1.90	6139-23	7.50 C
6067-35	.10	6083-63	1.50 C	6128-6	1.20	6139-24	.12
6067-37	.30	6083-65	.30	6128-8	3.70	6139-25	3.00 C
6067-38	.30	6083-67	.10	6128-12	4.00	6139-28	.30
6067-40	8.00 C	6083-68	*8004-9	6128-13	4.00	6139-31	1.50 C
6067-41	.14	6083-71	1.80 C	6128-29	5.80	6139-32	*6139-44
6067-42	.10	6083-74	8.00 C	6128-31	5.50	6139-35	.50
6067-43	.30	6083-77	3.70 C	6128-32	6.00	6139-36	.25
6067-44	.08	6083-81	.300 C	6128-33	8.00	6139-37	*6139-44
6067-45	.20	6083-83	.02	6128-34	5.10	6139-44	7.5 C
6069-6	4.50 C	6085-1	1.10	6128-35	3.60	6139-45	4.00
6069-9	7.50 C	6085-3	1.50	6128-37	3.60	6139-51	.12
6069-10	.14	6085-4	1.50	6128-44	4.20	6139-53	8.00
6069-11	.22	6085-7	1.50	6128-54	4.80	6139-55	1.40 C
6069-12	.22	6085-9	1.50	6128-55	6.00	6139-56	8.00
6069-13	7.50 C	6085-10	*6085-11	6128-56	5.50	6139-58	.05
6069-17	.30	6085-11	1.50	6129-1	3.00	6139-65	.08
6069-18	.30	6085-14	*8040-57	6129-2	3.30	6139-72	.08
6069-24	.22	6085-15	2.00	6129-7	3.70	6139-74	.06
6069-27	4.50 C	6085-16	4.50	6129-9	3.30	6140-132	5.50

* Recommended substitute.

ALL PRICES SUBJECT TO CHANGE WITHOUT NOTICE

REFRIGERATION PARTS PRICE LIST—Continued

PART NUMBER	LIST PRICE or Substitute	PART NUMBER	LIST PRICE or Substitute	PART NUMBER	LIST PRICE or Substitute	PART NUMBER	LIST PRICE or Substitute
6140-133	5.50	6141-229	1.40	6146-58	.22	6181-16	7.00
6140-134	3.50	6141-230	.75	6146-59	.22	6181-17	4.50
6140-135	3.50	6141-231	1.00	6146-60	.30	6181-18	4.00
6141-89	1.20	6141-233	1.80	6146-61	.30	6181-19	8.00
6141-90	.90	6141-236	1.40	6146-65	.22	6181-20	7.00
6141-91	1.30	6141-237	1.20	6146-68	.30	6181-21	3.70
6141-93	1.00	6141-238	1.00	6146-75	.22	6182-1	.96
6141-94	1.50	6141-239	1.00	6146-109	.36	6182-2	1.80
6141-95	.80	6141-240	1.00	6146-110	.44	6182-4	1.30
6141-96	.75	6141-241	.50	6146-111	.30	6182-7	*6182-22
6141-97	.80	6141-242	.80	6146-112	.30	6182-9	2.20
6141-98	1.20	6141-243	1.50	6146-113	.18	6182-10	*6182-17
6141-99	.80	6141-244	1.80	6146-114	.30	6182-11	*6182-22
6141-100	1.30	6141-245	.80	6146-117	.30	6182-12	*6182-24
6141-101	1.30	6141-246	*6141-247	6146-118	.30	6182-13	1.30
6141-102	1.50	6141-247	.70	6146-119	.22	6182-15	*6182-22
6141-103	1.30	6141-250	.80	6146-122	.22	6182-17	1.60
6141-104	1.30	6141-254	3.00	6146-123	.24	6182-21	.20
6141-105	1.00	6141-255	.90	6146-124	.15	6182-22	1.20
6141-106	1.30	6141-256	1.30	6146-125	.20	6182-23	1.80
6141-108	1.50	6141-257	1.30	6146-126	.20	6182-24	1.30
6141-109	1.10	6141-258	2.50	6146-127	.26	6182-25	1.50
6141-110	1.00	6141-262	1.30	6146-129	.36	6182-26	1.80
6141-111	1.00	6141-263	1.60	6146-130	.30	6182-27	1.00
6141-112	.80	6141-264	1.50	6146-131	.40	6182-28	1.80
6141-114	.70	6141-265	1.50	6146-132	.20	6182-29	1.10
6141-115	.80	6141-266	2.00	6146-133	.26	6182-30	1.60
6141-116	.70	6141-267	1.90	6146-140	.18	6182-31	1.40
6141-124	1.10	6141-268	1.70	6146-143	.90	6182-32	1.50
6141-125	1.10	6141-273	1.00	6146-144	.90	6186-4	3.00
6141-126	.90	6141-274	*6141-254	6146-145	1.20	6186-6	1.80
6141-127	1.20	6144-6	.22	6146-147	1.90	6196-7	3.70
6141-134	.75	6144-7	.30	6146-150	2.10	6196-14	2.60
6141-135	.75	6144-7	.22	6146-151	1.20	6197-4	.30
6141-136	.70	6144-18	.22	6146-153	1.50	6187-5	.36
6141-137	1.00	6144-20	.30	6146-154	2.00	6187-15	.22
6141-138	1.25	6144-21	.30	6146-156	4.00	6187-26	.22
6141-139	1.00	6144-22	.22	6146-157	1.70	6187-31	.30
6141-140	1.00	6144-23	.22	6146-158	1.00	6187-33	.04
6141-141	.90	6144-27	*6144-33	6146-159	.80	6187-34	.04
6141-144	2.50	6144-28	*6144-34	6146-160	1.40	6187-38	.06
6141-145	1.30	6144-29	.34	6146-161	1.40	6187-44	.12
6141-146	2.50	6144-31	.40	6146-162	1.60	6187-51	.15
6141-147	2.50	6144-33	.30	6147-5	18.00	6187-57	*6187-34
6141-148	.80	6144-34	.20	6147-12	*8040-58	6187-58	*6187-33
6141-149	1.00	6144-36	.20	6148-1	.15	6187-59	.40
6141-151	1.70	6144-37	.40	6148-2	.15	6187-63	.10
6141-152	2.70	6144-38	.40	6148-3	.10	6187-64	.10
6141-153	2.70	6146-1	.44	6148-4	.10	6187-68	1.00
6141-154	2.70	6146-3	.60	6148-5	.15	6187-77	.20
6141-175	.36	6146-4	.30	6148-6	.15	6187-83	1.00
6141-181	2.10	6146-5	.36	6150-1	.60	6187-86	.16
6141-183	.80	6146-7	.36	6152-1	2.00	6187-98	.08
6141-184	1.00	6146-8	.36	6159-1	.10	6189-1	.15
6141-185	1.00	6146-11	.36	6159-3	3.00 C	6191-11	.40
6141-201	2.60	6146-12	.22	6159-4	5.40 C	6191-13	1.30
6141-203	2.80	6146-13	.30	6164-3	3.00 C	6191-14	.50
6141-204	2.80	6146-16	.22	6164-4	1.10 C	6191-15	.30
6141-205	3.00	6146-17	.30	6164-5	3.00 C	6192-1	.44
6141-206	3.30	6146-18	.50	6170-1	4.00	6192-2	.30
6141-207	3.30	6146-19	.36	6170-2	2.20	6192-3	.30
6141-208	3.30	6146-20	.36	6170-5	5.60	6192-4	1.10
6141-209	3.30	6146-21	.30	6170-6	2.20	6192-5	1.10
6141-211	2.60	6146-24	.22	6170-7	2.50	6192-6	.90
6141-212	1.10	6146-25	.30	6170-8	5.60	6192-7	1.50
6141-213	1.20	6146-35	.90	6170-10	7.20	6192-8	1.50
6141-214	1.20	6146-38	1.20	6170-12	14.00	6192-9	1.50
6141-215	1.50	6146-40	.30	6177-3	6.00	6192-10	1.50
6141-216	.90	6146-42	.30	6177-15	6.30	6192-12	2.60
6141-217	1.00	6146-43	.22	6177-16	7.00	6192-13	.22
6141-218	1.00	6146-45	.36	6180-1	4.20	6192-20	*5692-22
6141-219	1.30	6146-46	.30	6181-2	3.70	6192-21	1.80
6141-220	1.00	6146-47	.20	6181-3	7.50	6192-24	.75
6141-221	.80	6146-48	.22	6181-6	7.00	6192-31	1.50
6141-222	1.20	6146-50	.22	6181-7	3.70	6192-32	.30
6141-223	1.50	6146-51	.15	6181-10	4.50	6192-33	1.90
6141-224	1.90	6146-54	.36	6181-13	3.70	6192-34	1.90
6141-225	2.60	6146-55	1.40	6181-14	2.60	6192-38	.44
6141-228	1.20	6146-56	.44	6181-15	8.00	6192-39	4.50
						6192-42	2.60

* Recommended substitute.

ALL PRICES SUBJECT TO CHANGE WITHOUT NOTICE

REFRIGERATION PARTS PRICE LIST—Continued

PART NUMBER	LIST PRICE or Substitute	PART NUMBER	LIST PRICE or Substitute	PART NUMBER	LIST PRICE or Substitute	PART NUMBER	LIST PRICE or Substitute
6192-43	1.10	6246-62	24.00	6285-51	.14	6394-5	3.30
6192-51	1.10	6246-64	24.00	6288-2	3.70	6394-6	3.80
6192-52	1.50	6246-65	18.00	6288-3	3.80	6394-7	5.30
6192-53	1.30	6246-66	10.00	6288-8	1.00	6394-8	6.00
6192-55	.40	6246-67	15.00	6289-3	.30	6394-9	7.20
6192-56	2.00	6246-68	25.00	6289-5	2.70	6394-10	8.00
6192-59	.70	6246-69	25.00	6292-1	.12	6394-13	5.50
6192-60	.90	6246-70	25.00	6292-2	.30	6394-14	9.00
6192-63	1.90	6248-13	*6048-13	6296-6	4.00 C	6395-2	2.30
6192-66	.90	6253-1	.90	6296-8	*8640-5	6395-4	4.60
6192-68	3.20	6256-1	.44	6296-9	*8640-5	6395-5	3.30
6192-70	2.70	6258-2	2.20	6296-11	.30	6395-7	3.30
6192-73	.26	6262-1	1.30	6296-12	.50	6395-8	3.30
6192-74	.80	6266-1	.22	6296-13	.60	6395-9	4.70
6193-7	5.60	6266-2	.15	6296-15	.44	6395-11	3.50
6193-8	12.00	6267-1	.30	6296-18	.60	6395-12	5.00
6193-9	10.00	6267-2	*6269-1	6296-20	.36	6398-2	*6025-80
		6267-3	.30	6296-22	.14	6398-3	6.00
6203-44	.60	6268-1	1.50	6296-23	.20	6398-4	7.20
6203-90	.10	6269-1	2.20	6296-36	.60	6398-5	6.70
6203-108	.20	6270-1	.44	6296-46	.06	6398-6	8.00
6203-117	.50	6270-2	.36	6296-48	.16	6398-7	6.00
6203-118	.50	6272-5	22.00	6298-1	4.50	6398-8	5.50
6213-9	1.90	6272-6	25.00	6299-32	1.30	6398-9	7.00
6213-11	1.20	6272-7	25.50	6299-34	.70	6398-10	6.50
6213-14	1.30	6272-8	30.00			6399-2	3.30
6213-15	.90	6273-3	*6273-11	6316-1	*5584-5	6399-3	4.00
6213-18	1.00	6273-7	*6273-11	6316-2	*5584-6	6399-4	4.30
6213-21	1.20	6273-9	50.00	6323-6	.20	6399-6	4.20
6213-22	1.20	6273-11	28.00	6323-7	.30		
6213-23	.90	6273-12	35.00	6323-8	.30	6500-5	7.50
6225-3	.30	6274-1	*6269-1	6323-14	.30		
6226-3	.50	6276-2	.36	6325-1	6.00	7086-1	.26
6226-11	.80	6278-1	4.80	6325-2	6.00		
6226-12	1.00	6280-1	.90	6325-5	5.60	7103-10	1W11510FA22
6226-18	.36	6280-4	1.50	6325-12	4.50	7105-11	*2W11515FA7
6231-1	1.50	6280-6	1.30	6325-13	4.10	7119-3	1W11325FA22
6231-2	1.50	6280-9	1.50	6325-14	4.50	7119-4	1W11327FA22
6231-3	.90	6280-17	1.50	6325-16	.50	7128-7	4.00 C
6235-1	.10	6280-19	1.50	6325-18	*6326-8	7131-1	3.00 C
6236-2	3.70	6280-21	1.50	6326-2	*6326-7	7135-6	2W11511FA7
6236-3	3.70	6280-22	1.50	6326-4	*6326-8	7140-2	*1W12063FA2
6236-8	4.50	6280-23	1.50	6326-6	2.30	7147-2	3.00 C
6236-9	4.50	6280-24	1.90	6326-7	2.60	7147-4	5.20 C
6236-10	8.00	6280-28	1.60	6326-8	3.00	7147-5	5.00 C
6236-13	3.00	6280-29	1.50	6328-1	*6055-44	7149-1	4.40 C
6236-14	3.00	6280-30	6.00	6328-2	1.30		
6236-19	8.00	6280-31	3.20	6328-3	1.40	7228-2	*9W19580
6236-21	*8040-58	6280-33	.20	6328-5	1.00	7263-4	*1W19446FA22
6236-22	10.40	6280-34	.14	6333-1	1.10		
6236-23	3.50	6280-35	1.60	6333-3	1.50	7382-4	4.40 C
6236-24	4.00	6280-40	1.00	6335-4	3.50	7382-7	4.40 C
6236-25	5.00	6280-42	2.00	6335-8	5.60	7382-8	4.40 C
6236-26	5.00	6281-1	.60	6335-9	4.00	7444-8	1.40 C
6236-27	10.00	6281-2	.44	6335-11	6.60	7454-5	.14
6236-32	9.00	6281-3	.90	6335-12	4.50	7457-1	.14
6236-33	10.00	6281-4	.80	6335-16	4.50	7457-10	.14
6239-1	.30	6281-5	.74	6335-17	5.20	7467-3	.14
6239-2	.30	6281-6	1.00	6338-2	.60	7471-9	*1W52457FA3
6239-3	.30	6281-7	.74	6339-1	2.50	7482-2	*1W35047FA22
6239-4	.30	6281-11	.70	6340-9	14.00		
6241-1	.15	6281-13	.80	6340-12	10.00	7519-4	7.40 C
6245-55	*6246-55	6281-14	.44	6340-22	14.00	7519-7	*8622-4
6246-12	15.00	6281-15	.50	6340-23	14.00	7519-9	*8622-2
6246-15	12.50	6281-16	1.00	6340-26	15.00	7527-1	*2W44124FA3
6246-22	10.50	6281-26	1.00	6340-27	15.00	7546-1	1.00 C
6246-31	16.00	6281-33	.90	6341-4	1.20	7550-2	*2W10937FA8
6246-34	18.00	6282-2	2.50	6341-5	1.10	7551-20	*1W11888FA3
6246-35	18.00	6282-13	*6280-22	6341-6	1.00	7552-1	6.00 C
6246-43	*6246-44	6282-22	3.00	6341-11	5.60	7575-1	6.00 C
6246-44	16.20	6284-1	.36	6341-14	6.30	7576-1	3.60 C
6246-45	18.20	6285-4	.14	6342-1	4.50	7581-1	4.40 C
6246-46	*6246-45	6285-7	.14	6342-2	5.20	7599-1	*2W12180FA7
6246-47	21.00	6285-14	.74	6342-3	*6340-9		
6246-48	21.00	6285-15	.12	6342-4	*5641-5	8001-1	1.40 C
6246-51	17.00	6285-21	3.00	6342-5	6.70	8001-3	7.40 C
6246-54	*6246-45	6285-30	.60	6343-2	*6343-5	8001-4	7.40 C
6246-55	27.00	6285-38	.14	6343-3	2.40	8001-8	7.40 C
6246-56	18.00	6285-40	.04	6343-5	1.85	8001-9	7.40 C
6246-58	12.50	6285-42	.30	6394-4	*6128-55	8001-10	5.00 C
						8001-12	7.00 C

* Recommended substitute.

ALL PRICES SUBJECT TO CHANGE WITHOUT NOTICE

REFRIGERATION PARTS PRICE LIST—Concluded

PART NUMBER	LIST PRICE or Substitute	PART NUMBER	LIST PRICE or Substitute	PART NUMBER	LIST PRICE or Substitute	PART NUMBER	LIST PRICE or Substitute
8001-13	3.60 C	8022-4	.15	8606-2	1.00	8641-15	1.80C
8001-14	6.00 C	8023-2	7.40 C	8608-1	.80	8641-16	8.00C
8001-17	2.20 C	8023-4	3.00 C	8613-1	2.30	8641-17	.10
8001-18	7.40 C	8023-6	3.80 C	8614-1	.14	8641-18	.60C
8001-21	.14	8023-7	3.80 C	8617-1	1.20 C	8641-20	.12
8001-26	2.40 C	8023-8	3.00 C	8618-2	.36	8641-25	.02
8001-27	4.80 C	8023-16	.05	8618-3	.30	8641-28	6.00C
8001-29	.04	8023-18	3.00 C	8622-1	2.60 C	8641-32	3.00C
8001-31	.08	8023-19	.03	8622-2	4.00 C	8641-38	1.20C
8001-32	.04	8025-1	.14	8622-3	.80 C	8641-44	.03
8002-9	6.00 C	8025-2	7.40 C	8622-4	6.00 C	8641-56	3.00C
8002-10	7.40 C	8027-1	.12	8622-5	1.40 C	8642-4	.60C
8002-11	9.00 C	8027-4	6.00 C	8622-6	6.00 C	8642-11	.30
8003-1	.14	8028-3	7.40 C	8626-1	.14	8645-1	4.00C
8003-5	2.40 C	8028-4	8.00 C	8631-2	.08	8649-6	2.00C
8003-6	3.00 C	8028-5	8.00 C	8632-1	4.40 C	8649-7	2.40C
8003-7	.02	8028-6	.18	8639-3	4.40 C	8651-1	.05
8003-8	2.00 C	8028-7	.18	8639-6	1.20 C	8653-1	.20
8003-10	2.50 C	8040-13	†	8639-7	2.40 C	8653-3	.30
8004-1	1.40 C	8040-15	†	8639-8	4.00 C	8653-4	.30
8004-8	1.40 C	8040-17	10.50	8639-9	2.00 C	8654-1	.10
8004-9	.40 C	8040-18	16.50	8639-10	2.20 C	8654-8	15.00
8004-15	.60 C	8040-19	15.00	8639-13	.36	8675-9	10.00
8004-22	*8004-1	8040-20	21.00	8639-17	.05	8675-10	18.00
8004-26	1.40 C	8040-21	10.00	8639-18	2.00 C	8675-11	16.00
8004-29	1.40 C	8040-22	10.50	8639-20	*2W14027FA3	8888-22	*4316-2
8004-30	1.40 C	8040-26	16.00	8639-21	*SW10328	8900-1	*8020-3
8004-32	*8004-1	8040-29	5.00 C	8639-23	*8639-31	8901-14	3.80
8004-34	2.20 C	8040-33	1.50	8639-29	*8639-31	8901-18	3.60
8004-38	.30	8040-54	13.50	8639-31	.30	8901-24	3.40
8004-40	.40	8040-57	3.30	8639-33	.20	8901-30	1.20
8004-41	.24	8040-58	15.00	8639-35	.20	8901-37	2.20
8004-43	1.20 C	8043-1	4.40	8639-36	.20	8901-55	3.80
8006-1	*8006-20	8043-2	3.70	8639-37	.20	8901-56	2.30
8006-7	.56	8046-2	8.00	8639-42	.04	8901-57	1.60
8006-10	.56	8049-1	6.00	8640-2	.18	8902-1	*8902-3
8006-13	.20			8640-3	7.40 C	8902-4	*8902-6
8006-16	.74	8506-113	.36	8640-5	2.20 C	8902-5	.90
8006-17	.74	8506-128	.10	8640-7	5.20 C	8902-6	2.20
8006-19	.66	8506-188	.20	8640-8	*8640-24	8905-10	9.00
8006-20	.36	8520-2	6.00 C	8640-10	1.40 C	8905-12	8.80
8009-3	3.00 C	8520-4	1.80 C	8640-11	1.00 C	8907-17	24.00
8009-4	.60 C	8520-7	3.00 C	8640-12	.05	8907-19	29.00
8009-5	.02	8520-8	1.80 C	8640-13	.04	8907-20	23.00
8009-7	*8009-10	8520-15	.04	8640-18	.18	8907-21	23.00
8009-9	.04	8520-16	.03	8640-19	8.00 C	8913-14	20.00
8009-10	6.00 C	8520-17	.06	8640-20	8.00 C	8913-17	40.00
8011-4	3.00 C	8520-18	.04	8640-22	1.80 C		
8012-2	3.00 C	8521-5	3.00 C	8640-24	2.80 C	13676-R-3	2.00
8018-3	4.40 C	8522-5	3.00 C	8640-25	.20	13691-A-2	6.00
8018-6	6.00 C	8538-14	*8902-6	8640-29	.44	13691-A-2A	.90
8018-8	.14	8538-16	*8902-6	8640-32	.02	13691-A-22	.68
8018-9	.14	8538-18	*8902-6	8640-33	4.20 C	13691-A-2-X	.80
8018-12	.24	8538-25	*8902-6	8640-37	.08	13691-A-2-Y	3.20
8018-13	.06	8538-26	*8902-6	8640-40	.14	13691-A-2-Z	.90
8022-3	4.40 C	8605-1	.10	8641-5	4.80 C	T-33-1	3.40

* Recommended substitute.

† Refer to distributor.

ALL PRICES SUBJECT TO CHANGE WITHOUT NOTICE

AIR CONDITIONING PARTS PRICE LIST

PART NUMBER	LIST PRICE or Substitute	PART NUMBER	LIST PRICE or Substitute	PART NUMBER	LIST PRICE or Substitute	PART NUMBER	LIST PRICE or Substitute
2701-1	2.50	4563-6	3.40	173510	.14	S-449309Y	8.50
2710-2	.44	4563-8	6.00	173524	1.00	S-449316Y	4.00
2730-3	1.50	4563-9	1.30	173531	6.00 C	S-449318X	4.20
2801-1	3.70	4565-1	.90	173532	.06	S-449320V	.90
2810-1	.36	4565-3	.90	176422	1.50	S-449334X	2.40
2810-2	.36	4573-4	.30	176423	.24	S-449336X	2.40
2815-1	.10	4573-6	2.00	176424	.70	S-449337X	3.80
		4577-1	*4577-4	176426	44.00	S-449339Y	13.00
4201-1	.60	4577-2	*4577-5	176428	5.00	S-449351Y	15.00
4250-1	.12	4577-4	1.80	176431	.44	S-449364Y	15.00
4252-1	.26	4577-5	.84	176434	.14	S-449370	*P-203234
4253-1	.30	4587-1	.20	176441	1.90	S-452208	.56
4254-1	.14	4587-12	.40	176443	*1W24516FA2	S-452209	.56
4254-2	.14	4587-13	3.50	176445	.20	S-452229	10.50
4270-1	11.50	4587-14	.30	176447	.44	S-452234	2.20
4270-2	11.00	4587-16	3.20	176449	.14	S-452250	9.00
		4587-17	.30	177950	55.00	S-452257	*S-461826
4301-1	*5198.4	4587-35	.40	177953	20.00	S-452282V	9.00
4303-1	17.00	4588-2	.02	177955	1.00	S-452294	60.00
4309-1	.60	4592-1	.18	177956	1.80	S-453586	.76
4314-1	7.50	4592-2	.15	177957	.50	S-456505	70.00
4316-2	8.50	4592-4	.20	177958	13.50	S-456515	4.50
4318-1	.44	4592-8	.30	177961	10.00	S-456533	2.60
4320-1	4.30			177962	.90	S-456538	6.30
4320-2	4.00	4606-1	1.80	177963	.30	S-456539	45.00
4320-3	4.00	4606-2	1.80	177964	*177967	S-456540	95.25
4325-1	6.00	4606-3	.50	177981	8.40	S-456542	6.00
4325-2	5.40	4606-4	.20	177984	1.10	S-457450	2.10
4329-1	.50	4614-1	1.00	177988	*P-402562	S-457454	1.80
4330-1	2.00	4614-2	.86	177995	.60	S-457479	*F-461809
4331-1	.50	4614-3	1.00	177996	.44	S-457487	*F-461810
4331-2	1.10	4616-1	.40	177997	.20	S-457491	4.80
4332-1	10.00	4616-2	.40	177999	*177961	S-457496	*F-461811
4332-4	8.50	4622-1	1.00			S-461826	70.00
4333-1	.08	4632-1	.34	181054	.50	S-461841	1.26
4334-1	1.60	4635-3	1.30	181055	1.00	S-461851Z	20.00
4334-2	*4334-1					S-461856X	7.30
		4920-1	19.00	A-4024	7.00 C	S-473169	1.80
4502-1	†	4920-2	22.00	A-4025	.12	S-473171	.50
4502-3	†	4920-3	35.00	A-4026	3.00 C	S-473172	.50
4510-4	*4502-1	4920-4	16.00			S-473176	5.30
4511-1	1.30	4921-1	6.80	443828	92.00	S-473190	3.20
4511-2	1.40	4924-1	1.80	443884	102.00	S-473191	3.20
4511-3	.44	4924-2	1.80			S-473194	8.80
4511-4	.40	4925-1	2.20	S-437766Y	60.00	S-473196	†
4511-6	.40	4925-3	.40	S-442137	*S-442137X	S-476134	5.70
4511-8	.06	4925-4	.40	S-442137X	1.60	S-476754	6.20
4513-2	2.00	4925-5	2.00	S-442138Y	8.00	S-476763	5.50
4515-2	12.00	4926-1	.20	S-442169X	3.50	S-476770	2.80
4515-3	7.50	4930-2	1.50	S-442170X	6.50	S-476778	5.70
4515-4	7.50	4978-1	30.00	S-442171X	6.50	S-476780	10.50
4518-1	4.50	4978-2	2.60	S-442172X	6.30	S-476790	†
4520-1	11.00	4980-2	.20	S-442174Y	55.00	S-476791	5.50
4520-2	11.00	4981-1	.14	S-442188Z	4.50	S-476802	3.70
4521-2	5.00	5192-4	7.50	S-442199Y	*S-452229	S-476804	40.00
4527-3	14.00	5198-4	4.00	S-445047Y	50.00	S-476805	3.20
4536-1	1.80			S-445056X	10.00	S-476816	4.30
4536-2	5.50	5220	8.00	S-445062X	6.30	S-476832	3.70
4537-2	4.80			S-445082X	2.80	S-476979	10.00
4543-7	.50	8040-27	2.00 C	S-445083V	1.10	S-476980	2.80
4543-13	.40	8040-28	17.00	S-445086Y	3.50	S-476996	.90
4545-1	.60	8040-41	10.00	S-445091V	2.10	S-477000	.30
4546-2	.70			S-445093Y	3.60		
4547-1	.20	8611-2	1.00	S-445100	5.00	D-509	.14
4547-7	.50	8611-3	6.00	S-447301V	3.40		
4547-11	.08	117434	*176434	S-447323X	4.50	F-447319	9.50
4547-12	.06			S-447336X	6.50	F-456597	8.50
4549-17	.30	12857MA	5.80	S-447340X	3.30	F-456598	11.50
4550-1	1.40			S-447350V	3.30	F-456599	12.00
4550-2	4.50	146907	1.50	S-447358V	1.60	F-456600	25.40
4550-5	3.50	146908	.44	S-447359V	2.00	F-461805	40.00
4550-6	1.50	146909	.44	S-447360V	1.50	F-461809	10.00
4552-1	.20	146910	.36	S-447361V	1.80	F-461810	10.00
4556-1	.80	146912	1.00	S-447362V	5.50	F-461811	12.00
4558-1	6.40 C	146913	1.20	S-447363Y	3.90		
4560-2	4.50	146959	21.00	S-447370Y	6.50	P-1803	12.00
4560-4	4.80	149251	21.00	S-447396	3.00	P-4411	*P-10168
4563-1	1.80	150171	.14	S-447397	*P-447397	P-4513	*SP-4513
4563-3	3.00	150177	.14	S-449305X	6.40	P-4533	1.10
4563-5	3.00	156031	.14	S-449307Y	15.00	P-5670	15.00

* Recommended substitute.

† Refer to distributor.

ALL PRICES SUBJECT TO CHANGE WITHOUT NOTICE

AIR CONDITIONING PARTS PRICE LIST—Continued

PART NUMBER	LIST PRICE or Substitute	PART NUMBER	LIST PRICE or Substitute	PART NUMBER	LIST PRICE or Substitute	PART NUMBER	LIST PRICE or Substitute
P-5677	6.50	P-14770	.52	P-21748	.30	P-202844	.40
P-5684	.74	P-15155	15.00	P-21749	3.00 C	P-202858	.14
P-5692	.74	P-15165	6.00	P-22367	.14	P-202882	8.00 C
P-5773	15.00	P-15199	.22	P-22375	3.00	P-203069	1.60
P-5779	7.00	P-15200	*SP-15200	P-22376	3.96	P-203127	2.80
P-5800	5.00	P-15219	2.40	P-22380	3.00	P-203129	1.10
P-5801	4.00	P-15225	.30	P-22941	*P-25106	P-203130	2.70
P-5832	4.20	P-15232	1.00	P-22957	2.60	P-203174	6.00
P-5854	*P-10136	P-15233	9.00	P-22990	.74	P-203197	.30
P-5855	.74	P-15236	*SP-15236	P-25106	27.50	P-203199	1.00
P-5890	20.00	P-15242	*FP-15242	P-25107	1.20	P-203200	1.80
P-5897	2.70	P-15255	*FP-15255	P-25108	1.20	P-203215	*S-453586
P-5898	2.20	P-15293	*FP-15293	P-25110	40.00	P-203218	2.10
P-5928	.30	P-15505	12.00	P-25117	.48	P-203226	150.00
P-5929	.06	P-15506	32.00	P-25121	1.10	P-203227	*P-204993X
P-5930	.74	P-15507	32.00	P-25125	4.00 C	P-203229	1.10
P-5935	.90	P-15508	6.50	P-25163	59.60	P-203230	.60
P-6553	.74	P-15512	8.00	P-25165	56.00	P-203234	3.00
P-6554	.74	P-15517	.14	P-25174	3.00	P-203235	*203981
P-6555	.74	P-15518	.22	P-25175	.40	P-203238	.14
P-6875	4.00	P-15523	2.20	P-25176	.20	P-203253	.10
P-6876	1.50	P-15796	.74	P-25178	.44	P-203255	2.20
P-7383	20.00	P-15797	.74	P-25179	.60	P-203269	.60
P-9846	1.00	P-15810	.74	P-25180	*54-4105	P-203270	2.10
P-9849	.44	P-15811	.50	P-25194	.20	P-203271	2.00
P-10136	.90	P-15885	40.00	P-25195	.26	P-203294	2.20
P-10152	.90	P-16227	.74	P-25196	1.80	P-203297	.30
P-10155	2.50	P-16408	.44	P-25204	6.00	P-203362	175.00
P-10168	.30	P-16451	.48	P-25205	5.00	P-203363	120.00
P-10172	1.10	P-16473	3.60	P-25218	.18	P-203369	13.00
P-10188	.74	P-16480	1.10	P-25219	1.00	P-203464	2.10
P-10189	.74	P-16583	*FP-16583	P-25220	3.00 C	P-203503	.06
P-10207	.60	P-16584	*FP-16584	P-25222	.54	P-203504	2.00
P-10277	.50	P-16602	*FP-16602	P-25225	.84	P-203512	8.00
P-10323	.60	P-17112	1.10	P-25226	.84	P-203554	14.00
P-10342	.30	P-17113	.30	P-25227	.84	P-203556	10.00
P-10408	1.30	P-17438	.30	P-25228	.20	P-203557	11.00
P-10428	6.50	P-17470	96.00	P-25229	.44	P-203561	12.00
P-10448	.70	P-17477	1.80	P-25232	.14	P-203566	15.00
P-10506	52.00	P-17480	9.00	P-25250	1.00	P-203569	2.90
P-10612	.36	P-17481	7.00	P-25252	.42	P-203570	3.30
P-10613	.36	P-17488	60.00	P-25254	.36	P-203571	2.20
P-10617	.30	P-17490	7.50	P-25255	2.40 C	P-203572	2.30
P-10621	.30	P-17491	*P-25106	P-25262	.14	P-203573	3.70
P-10630	.36	P-17498	1.50	P-25272	12.00	P-203574	3.70
P-10636	1.10	P-17499	*P-202782	P-25275	3.50	P-203575	4.00
P-10664	30.00	P-1803	12.00	P-25285	.50	P-203596	8.00 C
P-10689	*SP-10689	P-19021	3.00	P-25286	*P-202776	P-203601	2.40
P-10702	*P-210898	P-19025	.60	P-25287	*P-202794	P-203602	1.30
P-10705	4.00	P-19027	.70	P-25708	20.00	P-203604	2.70
P-10709	.36	P-19028	.50	P-26025	.90	P-203608	7.00
P-10713	2.60	P-19032	3.70	P-26069	*P-25165	P-203609	1.50
P-10714	.80	P-19038	2.50	P-26073	*P-25106	P-203611	7.00
P-10733	.44	P-19043	.70	P-26076	*P-25163	P-203615	6.00
P-10737	.44	P-19044	7.00	P-26079	16.00	P-203619	19.00
P-11410	1.20	P-19045	*6498	P-26090	1.80	P-203620	22.00
P-12052	1.30	P-19059	52.20	P-201641	.14	P-203981	64.00
P-12144	*FP-12144	P-19061	7.00	P-201722	2.00 C	P-204056	2.00
P-12502	1.80	P-19065	72.00	P-201723	3.00 C	P-204058	16.00
P-12674	3.60	P-19071	1.00	P-201724	4.00 C	P-204184	16.00
P-12675	2.20	P-19072	.22	P-201898	3.00	P-204185	11.00
P-12676	3.70	P-19085	6.00	P-202365	.18	P-204187	11.00
P-12677	2.20	P-19086	1.10	P-202388	20.00	P-204188	8.50
P-12678	1.80	P-19091	.50	P-202454	*S-456542	P-204490	1.60
P-12729	7.50	P-19097	.52	P-202475	25.00	P-204639	.10
P-12880	*SP-12880	P-19234	6.00	P-202528	8.00	P-204648	1.50
P-12916	*FP-12916	P-19246	1.90	P-202622	*80-40-41	P-204707	4.60
P-12917	1.20	P-19260	*SP-19258	P-202623	.50	P-204752	5.00
P-12918	2.20	P-19261	*P-19262	P-202732	.66	P-204753	6.30
P-12919	.60	P-19262	2.20	P-202740	2.80	P-204755	.90
P-14728	1.10	P-19264	*P-442145	P-202741	.74	P-204759	.10
P-14733	.70	P-19276	.14	P-202742	13.00	P-204762	.24
P-14739	2.50	P-19280	.82	P-202776	5.00	P-204766	4.20
P-14741	.22	P-19290	.30	P-202777	1.60	P-204767	1.30
P-14742	.60	P-19314	.36	P-202778	40.00	P-204772	4.00
P-14743	1.86	P-19359	.36	P-202782	2.20	P-204775	.10
P-14744	.44	P-19376	*SP-19376	P-202783	.84	P-204778	.40
P-14746	8.00	P-19428	.30	P-202794	8.50	P-204779	.40
P-14749	2.20	P-21712	2.25	P-202801	.36	P-204783	2.70
P-14760	1.26	P-21746	2.00	P-202805	2.00	P-204785	6.30

* Recommended Substitute.

ALL PRICES SUBJECT TO CHANGE WITHOUT NOTICE

AIR CONDITIONING PARTS PRICE LIST—Concluded

PART NUMBER	LIST PRICE or Substitute	PART NUMBER	LIST PRICE or Substitute	PART NUMBER	LIST PRICE or Substitute	PART NUMBER	LIST PRICE or Substitute
P-204795	3.30	P-473166	.20	SP-19216	13.00	ISD-139	20.00
P-204860	3.70	P-473167	.20	SP-19245	6.00	ISD-150	22.00
P-204993X	50.00	P-473168	.20	SP-19250	5.50	ISD-177	6.50
P-204995	2.10	P-473170	.30	SP-19258	9.00	ISD-207	4.00
P-204998	50.00	P-473173	.20	SP-19259	.80	ISD-248	2.10
P-205000	80.00	P-473174	.20	SP-19265	4.50	ISD-250	.18
P-205018	12.00	P-473175	.10	SP-19269	7.50	ISD-261	8.00 C
P-300341	5.50	P-473186	.30	SP-19274	1.00	ISD-265	4.50
P-300363	8.00	P-473187	1.70	SP-19278	1.10	ISD-271	8.00 C
P-300479	*P-203569	P-473197	.30	SP-19313	.36	ISD-276	6.00
P-300522	*P-300645	P-473198	.30	SP-19327	.80	ISD-280	23.00
P-300528	12.00	P-476116	.30	SP-19342	*SP-19216	ISD-281	4.00 C
P-300645	7.50	P-476138	.30	SP-19376	12.00	ISD-282	*27-4326
P-402562	.50	P-476141	.30	SP-19447	9.00	ISD-284	3.00 C
P-431930	.30	P-476789	.06	SP-22848	1.20	ISD-285	3.00 C
P-442136	.26	P-476796	.20	SP-22860	1.20	ISD-291	3.00 C
P-442144	.22	P-476800	.20	SP-24387	4.80	ISD-292	2.00 C
P-442145	.48	P-476817	1.00	SP-25102	16.00	ISD-297	*1W23166FA2
P-442158	3.50	P-476818	.20	SP-25111	21.00	ISD-299	3.00 C
P-443808	2.50	P-476820	.50	SP-25121	1.10	ISD-332	*P-203561
P-443815	8.00	P-476821	.40	SP-25193	5.00	ISD-346	1.60 C
P-447342	.10	P-476827	.10	SP-25199	2.50	ISD-366	1.10
P-447347	.42	P-476893	*P-476983	SP-25261	50.00	ISD-372	2.10
P-447354	6.00 C	P-476969	.20	SP-25284	.80	ISD-376	2.10
P-447364Y	1.00	P-476983	.06	SP-26079	16.00	ISD-379	1.20
P-447392	.24	P-477904	1.70	SP-25291	1.80	ISD-380	2.10
P-449374	8.00 C			SP-26089	*SP-26090	ISD-382	.14
P-449375	.04	AC-212	.30			ISD-404	5.00 C
P-449383	.08	AC-213	.30	FP-10350	6.50	ISD-408	2.00 C
P-452206	.26	AC-214	7.00 C	FP-12144	9.00	ISD-415	1.00 C
P-452207	.26	AC-215	.36	FP-12916	9.00	ISD-432	.22
P-452210	.36	AC-218	.36	FP-15255	13.00	ISD-450	2.10
P-452222	.22	AC-240	4.00 C	FP-15293	9.00	ISD-470	3.00
P-452223	.18	AC-242	4.00 C	FP-16583	6.50	ISD-480	15.00
P-452232	.18	AC-266	14.00	FP-16584	9.00	ISD-589	3.00 C
P-452259	8.00 C			FP-16602	9.00	ISD-590	*1W36553
P-452260	6.00 C	SP-1301	7.00	FP-22929	90.00	ISD-591	*1W24895FA2
P-452261	.44	SP-4369	17.00	FP-22930	100.00	ISD-707	*1W24265FA2
P-452276	.75	SP-4513	6.00	FP-22939	*SP-26079	ISD-748	11.70
P-452277	.65	SP-5781	12.00	FP-22952	13.00	ISD-879	5.00 C
P-452279	.26	SP-5861	14.00			ISD-880	2.00 C
P-452295	.42	SP-7812	.36	ISD-7	3.70	ISD-881	1.00 C
P-452296	.42	SP-10216	25.00	ISD-8	*149251	ISD-890	2.10
P-453170	*P-473170	SP-10655	*SP-12880	ISD-9	7.50	ISD-895	16.00
P-456511	.50	SP-10689	10.00	ISD-32	2.60	ISD-897	2.10
P-456513	1.00	SP-12880	20.00	ISD-45	6.00	ISD-901	.14
P-456554	.04	SP-15155	15.00	ISD-100	3.00 C	ISD-903	8.00
P-456556	4.00	SP-15200	7.00	ISD-106	8.00 C	ISD-905	.06
P-457449	.20	SP-15236	.70	ISD-107	3.00 C	ISD-912	*P-202776
P-461812	.18	SP-15558	8.00	ISD-108	3.00 C	ISD-913	*P-202794
P-461829	.50	SP-15643	14.00	ISD-109	5.00 C	ISD-936	66.50
P-461853	.78	SP-15646	2.20	ISD-110	5.00 C	ISD-956	6.50
P-469941	.24	SP-15799	.44	ISD-115	3.00 C	ISD-973	10.00
P-473165	.20	SP-15821	6.50	ISD-116	3.00 C	ISD-974	7.50
		SP-16079	3.90	ISD-117	3.00 C		

* Recommended substitute.

ALL PRICES SUBJECT TO CHANGE WITHOUT NOTICE

SALES PROMOTIONAL MATERIAL—PHILCO PARTS AND ACCESSORIES



PHILCO TUBE DISPLAY

A window-display combination of five units, including two Giant Tube cartons and a handsomely colored decalcomania that will call attention to, and sell Philco Tubes for you. Colorful, strong and compact. Special decalcomania can be used on your store window inside or out.

PHILCO DRY BATTERIES...For Every	

PHILCO DRY BATTERY WALL CHART

Just the thing to hang on the wall for handy reference. Has all up-to-date battery replacement information for Philco and other makes. Get your Battery wall chart today from your Philco Distributor.

PHILCO Battery Displays



NEW PORTABLE RADIO BATTERY DISPLAY

Every season is Portable Radio time when you put this attractive new Philco Portable Battery display on your counter, or in your store window. Get yours now from your Philco distributor.



NEW FARM RADIO BATTERY DISPLAY

Set this display up on your counter or in your window to attract store traffic from the rural areas. Every farmer is a prospect for a Philco Farm Radio Battery.

PRICE LIST

PHILCO TUBE-PRICE CARD



PHILCO TUBES

Lists all current Philco Radio Tubes with latest list prices. Use it for reference in your tube department. Also contains tube complements of latest Philco Radio Models.

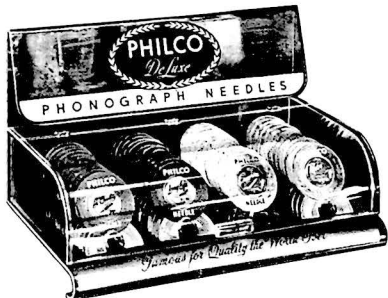

PHILCO NEEDLE MERCHANDISER

Enables you to have a complete Philco Phonograph Needle department in a few square inches of counter space. Magnificent, clear lucite counter case for displaying the only balanced line of fine jewel and precious-metal needles priced for easy sales.



PHILCO DeLuxe NEEDLE FLASHER DISPLAY

Put this handsome colorful flasher display to work for you and watch your Philco needle sales zoom.

PHILCO NEEDLE CONSUMER FOLDERS

Handy for use as a direct mail or package enclosure. Tells all about the Philco Phonograph Needle line.



PHILCO POLISH CONSUMER FOLDER

Tells real selling story on both Philco Furniture and Refrigerator Polish. Use them as package enclosures or mail them with monthly statements.

VOLUME-CONTROL RACKS

Available in two sections—one for the Philco Universal 3-inch shaft type, and the other for Philco Universal Shaft-Saver Controls. Each section contains 24 compartments and can be mounted on the wall or located on or near the repairman's work bench. Each section contains list of each Universal Volume Control with Philco Part Number and resistance. Ask your Philco Distributor how you can get these attractive, handy racks.

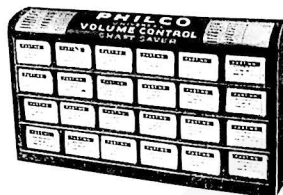

PHILCO TOOL DISPLAY

The kind of display that merchandises the Philco line of Tools. A revolving display made out of metal and wood, with display panels enclosed in glass. Ask your Philco Distributor how you can put one to work for you.

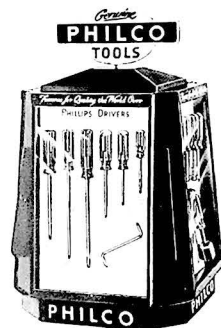

PHILCO PARTS HANGER CARD

Every Philco Dealer who maintains a Service Department should keep a fresh copy of this Hanger Card handy at all times. The self-addressed (to Distributor) postcards attached enable you to place rush orders for Philco Parts needed. Ask for copies from your Philco Distributor.



PHILCO SERVICE COAT

Here is a fine-quality, light-weight Service Coat. Has Philco Service insignia on left side. Gives your shop that dressed-up appearance. Ask your Philco Distributor how you can get these handsome Philco Service Coats.



SALES PROMOTIONAL MATERIAL — PHILCO PARTS AND ACCESSORIES (Cont.)

OUTDOOR BANNER AND SIGNS



METAL SIGN

Ask your Philco Distributor how you can get one of these long-lasting "Auto Radios Serviced" outdoor metal signs. Strongly made and colorful in appearance. Size: 19" x 70".

OUTDOOR DUCKTINE BANNER

Contains same copy as metal sign. For use outdoors. Just the thing for use in spring months as added display to get auto-radio-service business.



"AUTO-RADIOS-SERVICED" HANDBILLS

Dovetail your activity for spring and summer auto-radio-service business with a quantity of these attractive handbills. Size: 8 1/2" x 11". Unimprinted.

NEW PHILCO VIBRATOR WALL CHART

Complete up-to-date information for dealers and servicemen as to type of vibrator required for over 1,000 different makes and models of auto radios. Contains cross-index replacement guide.

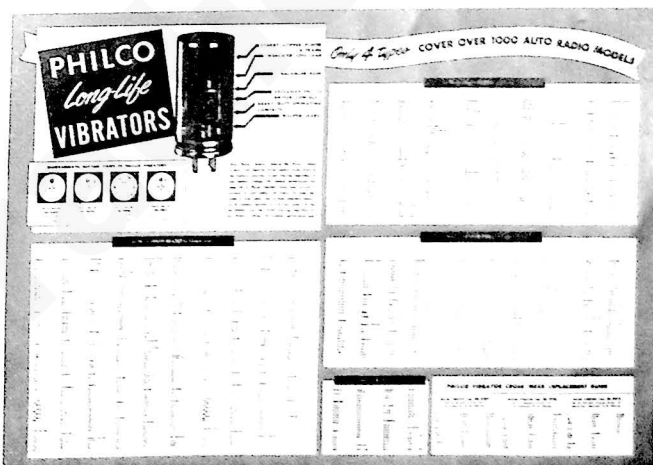

PHILCO DRY BATTERY MATERIAL



PHILCO DRY BATTERY CATALOGUE

Includes selling features and specifications for all Philco types, and replacement information for all makes of portable and farm radios.

DRY BATTERY POSTCARDS

Just the thing to mail to the unelectrified homes of your area. Mail one each month.





PHILCO ACCESSORY- PRODUCTS DISPLAY

A floor display that will help you acquaint your customers with Philco Accessory Products. Note the number of items it will show off for you. Put this display to work now and watch your Philco Accessory Products move. Can also be used to display Philco Batteries.

ALBUM LENGTH RECORD PLAYER DISPLAY

Just the display needed to help you sell the famous Philco Album Length Record Player. Attractive, colorful and compact.



PHILCO FM-DIPOLE-AERIAL WINDOW DISPLAY

Lots of FM-radio owners will buy a Philco Dipole Aerial when they know what it will do for them. Ask your Philco Distributor about this display and the accompanying smaller unit for use inside the store.

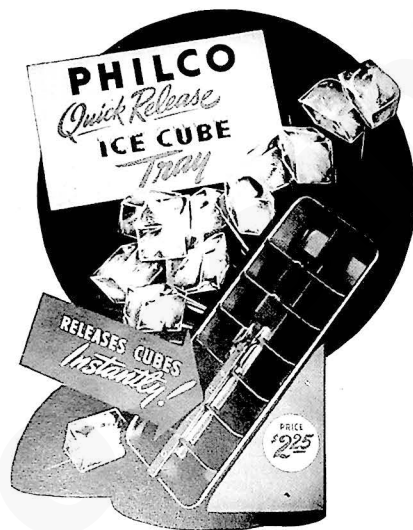

PHILCO ICE-CUBE TRAY DISPLAY

A splendid way to sell Philco Quick-Release Ice-Cube Trays. This display tells a potent story quickly and to the point.



PHILCO POLISH DISPLAY

Enables you to show both Philco Furniture and Refrigerator Polish in cans or in bottles. Display in five colors takes up little counter space. A real sales-getter.

SALES PROMOTIONAL MATERIAL—PHILCO AUTO RADIO



SMART NEW CR-2 COUNTER DISPLAY

Use this brilliant, full-color display to spotlight the popular CR-2. Convenient size—18" high, 15" wide, 12" deep; can be used in window or on counter.

AUTO AERIAL GUIDE

Chart shows proper aerial for each car. Place permanently on wall.



Brand New Reinforced FIVE-UNIT AUTO-AERIAL DISPLAY

A beautiful and effective aerial display that will help you sell more Philco Aerials for added profits. Colorful and really attention-getting. Plan to use it now to brighten up and get business for your shop or store.



32" x 40" AUTO RADIO WALL CHART

Shows the complete Line—with custom-styled control units for individual cars and all the new selling features. With this chart any retail salesman can sell

Philco Auto Radios. Heavy stock. Var-nished to keep clean.



REAR SEAT SPEAKER DISPLAY

A most attractive, colorful counter or window display that will help you sell many of the popular new Philco Rear Seat Speakers. Can be used for demonstration of unit.

TWO-UNIT AUTO-AERIAL DISPLAY

Attractively designed and a real plugger for more Philco Aerial Sales and increased profits for you. Colorful and effectively designed—for stores where space saving is of utmost importance. Use it now for effective merchandising.



CUSTOM STYLED PHILCO

Far Ahead
IN
**FEATURES, TONE
AND PERFORMANCE!**

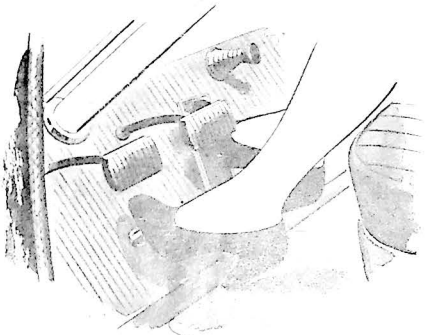

PHILCO FOOT CONTROL

A sensational feature to demonstrate—just step on it to tune in programs and change stations. No need to take your hands from the wheel, or your eyes from the road. Optional equipment. Profitable sales. (See page 45.)

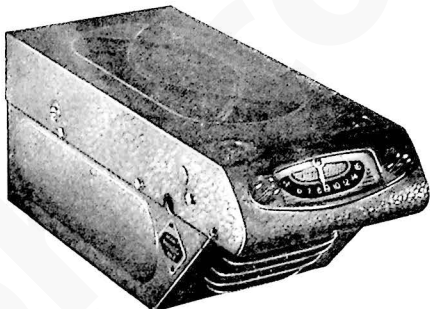

PHILCO MODEL CR-2

Most sensational value in the lowest-price range; manually operated. Built to give you amazing tone, power, sensitivity, and selectivity. Without question, this Philco Model CR-2 is the biggest money's worth in the entire Auto Radio field. Mounts neatly and attractively under the instrument panel of any car. Easy to reach . . . and easy to tune!

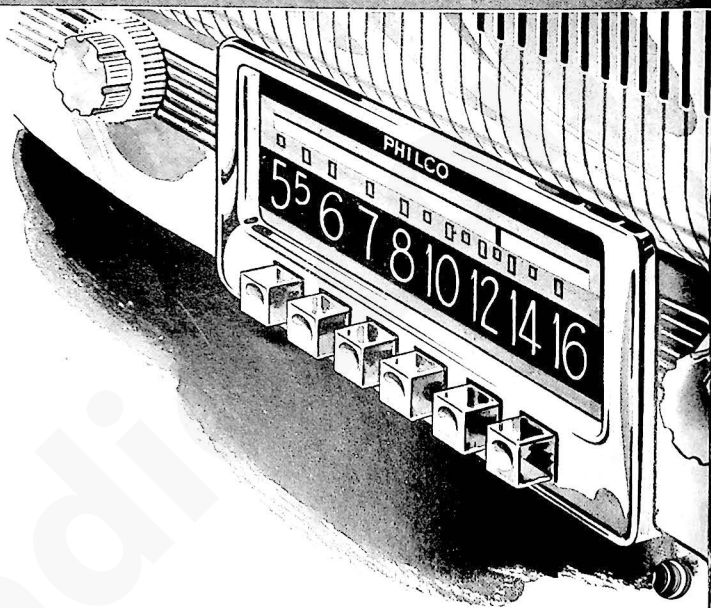

The Most Powerful Selling Advantages in the Auto Radio Business

. . . YOURS FROM PHILCO, THE LEADER

It's smooth-selling all the way—when you promote the feature-packed Philco Auto Radios. Spectacular selling features and values at every price level! Custom-styled installations for all modern cars! DeLuxe and popular-price models; automatic and manual tuning; with and without separate speakers! In addition, with Philco you have no service problems. The famous nationwide Philco Auto Radio service organization provides quick nearby installation and maintenance service by factory-trained experts. It leaves you free to concentrate on SALES—aided by powerful Philco advertising and promotional campaigns to help bring buyers into your store.

AUTO RADIOS



Universal Rear Seat Speaker Kit Model RS3



For any auto radio. See Metal Cutter Tool on page 105 for installing the kit.

Part No. 40-7606 List Price \$12.50

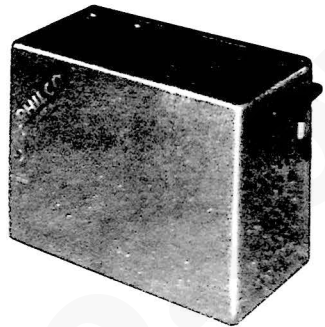

PHILCO MODEL CR-6

Philco's newest development in a fine auto radio with manual tuning. Very powerful and selective. Beautiful tone with big separate 7" electro-dynamic speaker. A sensational value at a popular price. Separate speaker is concealed behind grille provided in car. Chassis is housed in handsome, taupe-brown metal case mounted on fire wall.

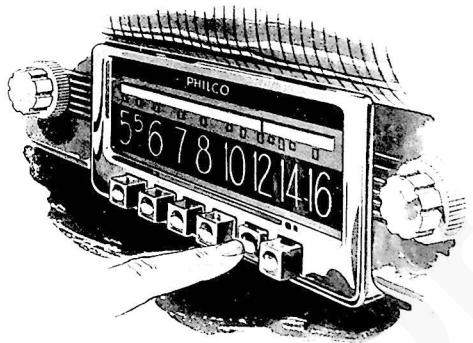

NEW PHILCO ELECTRONIC TUNING

Adds a new fascination to push-button tuning, as you hear and see the stations click by. War-developed invention gives the most accurate, positive station indexing ever achieved. Fool-proof; jam-proof.

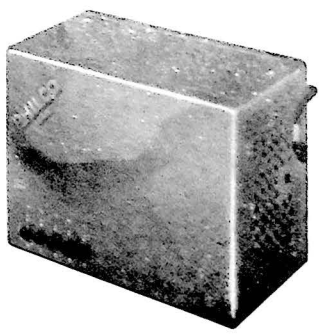

**PHILCO MODEL CR-8
AND DeLuxe CR-12**

All the new Philco advanced features—automatic electronic tuning, six push buttons, provision for foot control, big separate 7" speaker, miniature tubes. Finest performing auto radios ever offered at moderate price. Separate speaker is concealed behind grille provided in car. Chassis is housed in handsome blue-green metal case mounted on fire wall.

The new Philco CR-8 is the only moderate-price auto radio with all these ultra-modern features and convenience.

For those who demand auto-radio performance comparable in tone, power, sensitivity, and selectivity to the finer home sets. Philco has created the new DeLuxe Model CR-12.

PHILCO MODEL CR-4

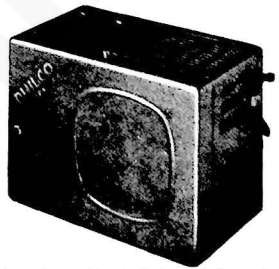

Fine-quality, single-unit, manually operated auto radio with powerful, built-in, 6" electro-dynamic speaker and new war-developed miniature-tube circuit—performance and value unequalled at this low price. Built-in speaker is concealed behind grille of radio housing. Chassis is housed in handsome, taupe-brown metal case, mounted on fire wall.

PHILCO

PARTS and ACCESSORIES

Catalog