

COMPLETE INSTRUCTIONS

FOR ADJUSTING ALL

Philco Radio Receivers



Prepared by

Philco Service Department

Especially for Members of

Radio Manufacturers Service

COMPLETE INSTRUCTIONS FOR ADJUSTING ALL PHILCO RADIO RECEIVERS

	PAGE
Introduction	3-6
PART I. Adjusting Procedure — Superheterodyne Models	6-9
Illustrations of Superheterodyne Chassis	10-21
PART II. Adjusting Procedure — Tuned R. F. Models	22
PART III. Adjusting Short-wave Converter and All-wave Receivers	23-30
PART IV. Adjusting Condensers in Neurodyne Plus Models	30
PART V. Adjusting Condensers in Philco Auto Radios	31-35



A PHILCO SERVICE PLAN

Prepared by
PHILCO SERVICE DEPARTMENT
Especially for Members of
Radio Manufacturers Service

INDEX OF INSTRUCTIONS

and

Table of Intermediate or Adjusting Frequencies

MODEL	TYPE	I. F. OR ADJ. FREQ. K. C.	ILLUSTRATION ON PAGE	INSTRUCTIONS ON PAGE
3	Tuned RF	1000-1200		31
4	Converter	3600	24	24-5
5	Superheterodyne	460	31	31-2
6	Superheterodyne	260	32	32-3
7	Superheterodyne	175	33	33-4
8	Superheterodyne	175	34	33-4
9	Superheterodyne	260	32	32-3
10	Superheterodyne	260	34	34-5
12	Superheterodyne -- (Code 121)	175	34	33-4
14	Superheterodyne -- (Code 121)	260	21	6-9
14	Superheterodyne -- (Codes 122 and 123)	175	10	6-9
15	Superheterodyne	175	10	6-9
16	Superheterodyne	460 & 3600	28	25-8
17	Superheterodyne	175	11	6-9
18	Superheterodyne	260	11	6-9
19	Superheterodyne	260	12	6-9
20	Tuned R. F.	1400		22
22	Superheterodyne	260	19	6-9
23	Superheterodyne	260	21	6-9
25	Superheterodyne	460	23	23-4
26	Superheterodyne	460	12	6-9
30	Tuned R. F.	1200-1400		22
35	Superheterodyne	260	12	6-9
36	Superheterodyne	260	12	6-9
37	Superheterodyne	175	13	6-9
38	Superheterodyne	460	14	6-9
41	Tuned R. F.	1200-1400		22
43	Superheterodyne	460	23	23-4
44	Superheterodyne	460 & 3600	29	29-30
46	Tuned R. F.	1200-1400		22
47	Superheterodyne	260	14	6-9
48	Superheterodyne	175	15	6-9
50	Tuned R. F.	1400		22
51	Superheterodyne	175	15	6-9
52	Superheterodyne	175	15	6-9
53	Superheterodyne	460	16	6-9 & 16
54	Superheterodyne	460	17	6-9
57	Superheterodyne	460	17	6-9
60	Superheterodyne	460	18	6-9
65	Tuned R. F.	1400		22
70	Superheterodyne	260	18-19	6-9
71	Superheterodyne	260	19	6-9
76	Tuned R. F.	1400		22
77	Tuned R. F.	1400		22
80	Superheterodyne	460	19	6-9
81	Superheterodyne	460	20	6-9
86	Neutrodyne Plus	1200-1400		30
87	Neutrodyne Plus	1200-1400		30
89	Superheterodyne	260	12	6-9
	(with 2-45)	175		
90	Superheterodyne (with 1-47)	260	20-1	6-9
	(with 2-47)	260		
91	Superheterodyne	260	21	6-9
95	Tuned R. F.	1400		22
96	Tuned R. F.	1400		22
111	Superheterodyne	175	10	6-9
112	Superheterodyne	175	10	6-9
470	Superheterodyne	260	19	6-9
490	Superheterodyne	260	21	6-9
511	Neutrodyne	1200-1400	30	30

INSTRUCTIONS

For Adjusting All Philco Radio Receivers

Prepared Especially for Members of

RADIO MANUFACTURERS' SERVICE

Purpose of this Book This book has been prepared to enable members of Radio Manufacturers Service to have complete instructions for adjusting all Philco receivers which they are called upon to service.

Necessity for Knowledge Since the fundamental requirement of Radio Manufacturers Service members is the possession of equipment and training to give expert radio service, it is absolutely essential that they be thoroughly familiar with the various steps in the process of adjusting all Philco models. No matter how well versed a serviceman may be in general repairs, unless he is able to make these adjustments correctly, he cannot place a receiver in perfect operating condition.

Equipment Needed All members of Radio Manufacturers Service own a set-analyzer and signal generator. Some have these two instruments combined in one unit, such as the Philco Model O-8 All-purpose Set Tester. Such an instrument is ideal from many standpoints. Its portability allows its use either in the shop or the customer's home.

For strictly shop or service station use the analyzer and signal generator requirements are equally well combined in a larger unit, such as the Philco Model 059 bench tester. This instrument also includes a test speaker and various field coils, so that any chassis may be connected to the tester, and is played through the test speaker (separately excited), while the speaker field requirements are provided in the tester.

Types of Sets Covered In order to simplify these instructions we will separate the various Philco models into four groups:

- | | |
|---------------------------|-----------------------------|
| Group 1—Super-heterodyne. | Group 3—"Neutrodyne Plus". |
| Group 2—Tuned R. F. | Group 4—Philco Auto Radios. |

Explanation of Philco Superheterodynes To assist you in understanding the extreme importance of the "padding" adjustments, a knowledge of the circuit and function of each of the above types is necessary, especially the Superheterodyne, since 90% of the sets in use today are of this type.

It will help you to understand the Superheterodyne receiver more readily if you will glance at the illustration below, and note that it consists of six main parts.

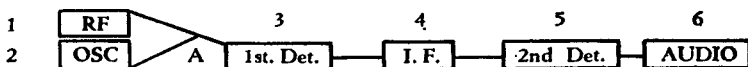

By following carefully as we briefly describe the function of each part of the circuit, you should have a good general idea of how the Superheterodyne functions.

"1" is the RF section or stage. This is similar to the first stage of a tuned RF receiver; however, in a Superheterodyne this first stage may or may not include a tube amplifier, depending on the model. In any case this stage amplifies the signal at its own frequency—760 KC, 1100 KC, etc., and is tuned by one section of the tuning condenser gang.

"2" is the "oscillator" section. This is a separate circuit which generates a signal of its own. Its condenser moves with the "gang", being on the same shaft. The oscillator coil and condenser are designed so that the oscillator's signal will always be a fixed amount above the incoming station's frequency. This fixed amount is equal to the "intermediate frequency" of the receiver.

As an example: Suppose an intermediate frequency of 260 has been decided upon. Then the oscillator circuit is so built that it will always generate a signal 260 KC above the station received. If the station is 700 KC, the oscillator generates 960KC; if the station is 1500 the oscillator generates 1760. The oscillator condenser must be very carefully adjusted so that the oscillator frequency exactly "tracks" with the incoming R. F. frequency all along the scale.

"3." Now refer to the illustration. At point "A" we have two signals entering the first detector — (1) the incoming R.F. signal, (2) the oscillator signal, which is (let us say) 260 K.C. higher. The two signals mix together in the first detector tube **"3"** and a *third frequency is produced* — 260 KC — this is the "intermediate frequency" of the receiver. At this frequency the signal passes into the "IF" amplifiers **"4."**

The reason for changing all incoming frequencies to the same "intermediate" frequency is this: The strength of a radio signal can be built up more efficiently in an amplifier designed for one fixed frequency only, therefore we mix the RF signal with an oscillator signal to produce the IF, which can then be greatly amplified. A further important reason is that this circuit arrangement in the Superheterodyne greatly increases the selectivity. Whatever the incoming RF frequency may be, the receiver does almost all of its amplification in its intermediate or IF stages.

The signal which has been amplified by the "IF" stages is finally passed into the second detector **"5"** where the audio signal is separated from the RF carrier. The audio amplifier **"6"** then provides sufficient volume to operate the speaker.

Summary. Reviewing the above:

1. We amplify the incoming signal in the radio frequency amplifier.
2. We mix the amplified signal with a generated oscillator signal, which is always a fixed amount higher in frequency.
3. Mixed together these produce the intermediate frequency, which is the difference between the two.
4. We amplify this intermediate frequency in the IF amplifiers.
5. We rectify the final signal and give it audio amplification.

Combination Tubes Recent developments in tube design have made it possible to combine the oscillator and first detector in one tube, however, the fundamental principle of the Superheterodyne remains the same. Receivers can now be built with less tubes than was possible some years ago, but with far greater sensitivity and selectivity.

Importance of Adjustments The proper functioning of a delicately balanced circuit arrangement like the Superheterodyne depends largely on the correct synchronizing of the various circuits. If only one of the circuits is out of balance, the receiver may become "dead"; consequently it is of the utmost importance that you understand how to make each of these adjustments, and the correct order in which to make them.

If it were possible to manufacture coils and condensers which would exactly match each other in capacity and inductance, and if variations in internal capacities of tubes did not exist, and placement of wiring never varied, the adjusting or compensating condensers would not be necessary, since the circuits would all match when the set was assembled. However, the minor variations in capacity and inductance which cannot be avoided in production, and the difference in capacity of tubes make it necessary to have each tuned circuit separately adjustable. Consequently, each variable condenser is shunted by a separate small variable condenser known as a "compensating" or "padding" condenser. By adjusting these little condensers, it is possible to overcome differences caused by tube capacity, etc., and bring all circuits into exact resonance.

As mentioned previously, it is extremely important that the oscillator frequency "tracks" or "follows" the incoming signal frequency all along the dial, maintaining the exact difference (IF) at all times. In order to make sure this condition exists, two adjusting condensers are provided to permit perfect synchronizing at both ends of the scale. These are known as the high frequency (HF) and low frequency (LF) oscillator adjustments. When they are properly adjusted, the oscillator should "track" accurately from one end of the scale to the other. The "Antenna" condenser allows balancing of the antenna circuit and the "RF" and "Detector" compensating Condensers "trim" these circuits respectively.

Procedure The IF circuits are first adjusted to the correct IF frequency, according to the table in this book. Next, the "high frequency" oscillator padding condenser is adjusted — according to detailed instructions given later in this book.

Third, the detector condensers, "RF" and "Antenna" are adjusted.

Fourth, the low frequency oscillator condenser is adjusted.

Fifth, a final readjustment of the high frequency oscillator condenser must be made to insure complete adjustment.

The service man who thoroughly understands the circuit of the receiver he is adjusting, and the proper function of each condenser, will be able to do a far more satisfactory servicing job than the untrained man, groping blindly in the dark. Understanding why a certain adjustment is made and what happens when it is or is not correctly adjusted will go a long way toward building up the serviceman's confidence and ability.

Equipment Required Complete equipment for adjusting the compensating condensers in all Philco receivers consists of:

1. A signal generator capable of generating a signal on any of the several frequencies employed as intermediate frequencies on Philco superheterodynes. A table of Philco models with corresponding intermediate frequencies will be found on the inside cover of this book.

2. An Output Meter for indicating the comparative output signal strength as the various circuits are being adjusted.

To take care of the above two requirements, either the Philco Model 048 "All-Purpose Set Tester," or the Model 059 Bench-Type Tester, is recommended. These units include a signal generator covering all necessary frequencies, and an efficient output meter.

The Philco Model 095 Tester, appearing in illustrations 1 and 2, can be used for adjusting sets having IF's of 175 or 260 KC; the Model 095B covers these two frequencies and also sets having IF of 450 KC.

3. A special fibre hex-nut wrench (Philco Part No. 3164), for adjusting the compensating condensers. Also a fibre adjusting screw driver, such as Philco Part No. 27-7059 is required for adjusting the later model Philcos.

4. For adjusting model 4 short-wave converter, also models 16 and 44 all-wave sets, a crystal controlled signal generator, which produces a 3600 KC signal is required. Philco Model 091 signal generator may be used for this purpose.

Functions of Equipment Used in Adjustments A signal generator such as contained in Philco Model 048 or 059 Testers, calibrated accurately to produce a signal at any desired frequency is the only satisfactory method of securing correct adjustment of the compensating condensers in a receiver. The principle of the signal generator is nothing more than the fundamental principle of resonance between radio circuits. When the generator is producing the desired frequency, the adjusting of the compensating condenser in the circuit being checked brings about resonance, resulting in maximum reading in the output meter connected to the output of receiver. When all the compensating condensers are correctly adjusted a maximum amplification of the signal is possible from the time it enters the receiver until it reaches the second detector tube of the set.

Your signal generator should be regularly checked for accuracy by comparing reception of harmonics of its signal with that of reliable stations of several frequencies in the broadcast band.

Part I. Adjusting Procedure — Superheterodyne Models

First determine the intermediate frequency of the set to be adjusted by referring to the table on Page 2 of this book.

The usual indications of a set being out of adjustment are poor sensitivity, poor selectivity, and dial readings more than 20 K.C. off. In some cases an unstable condition of the set, with a tendency to squeal or howl on certain sections of the dial, may be an indication of the need of adjustment.

The adjustments are then made in the following order:

1. INTERMEDIATE FREQUENCY (I.F.) ADJUSTMENTS. The adjustments of the I.F. compensating condensers should be done in the following manner:

1. Make the necessary connections between the signal generator and the receiver as shown in the illustration, Fig. 1. The connections consist of (a) the ground wire to the GND. terminal of the radio set and to the GND terminal of the signal generator; (b) the ANT. terminal of the signal generator through the necessary length of shielded lead, (shielding grounded) to the grid of the first detector tube (tube shield in place and first detector grid clip removed); (c) output meter terminals to the primary of the output transformer. If more convenient, this connection can be made to the two plates of the output tubes in the case of push-pull output circuits, or to the plate and cathode in the case of a single output tube; (d) power cord of receiver to the electric power outlet, after all other connections have been completed.

Shielded Wire

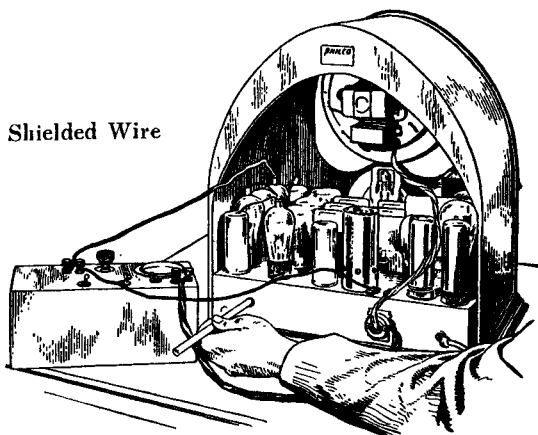
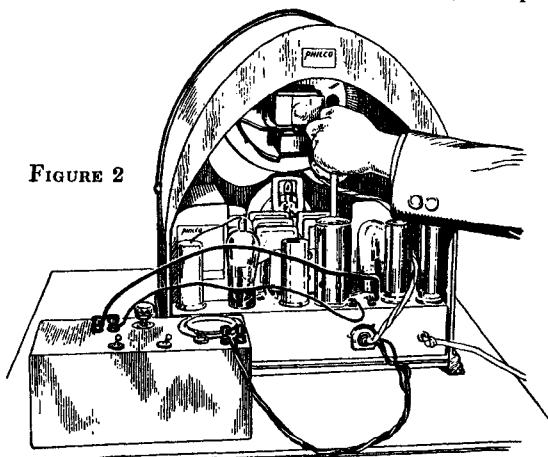

FIGURE 1

2. Turn on the radio set and the signal generator. Set the signal generator to the intermediate frequency of the Philco model being adjusted. (See Page 1 for the intermediate frequencies of all Philco Superheterodynes). When adjusting sets with a normal-maximum switch, the switch should be placed in the "normal" position; turn the radio volume control full "on." Set the dial to the low frequency end of the Philco scale. Adjust the signal generator control (attenuator) until a reading is obtained on the output meter, of approximately one-half the scale deflection.

3. By means of the Philco fibre wrench, part No. 3164, or fibre screw driver, part No. 27-7059, adjust the various intermediate frequency condensers, one at a time, to obtain maximum reading on the output meter. Locations of compensating condensers are shown in the illustrations of chassis on Pages 9 to 20 of this booklet. It is desirable to start with the I.F. compensating condenser nearest the second detector in the circuit, and progress in the adjustments toward the first detector. It may be necessary while the adjustments are being made to lower the setting of the signal generator attenuator control from time to time so as to keep the output meter reading within the scale range.

FIGURE 2



4. After these adjustments have been completed, remove the shielded antenna lead connection from the grid terminal of the first detector tube and restore the grid clip connection to this terminal.

5. The adjustment of the I.F. primary (coupling) condenser may have a slight ef-

fect on the adjustment of the low frequency compensating condenser in the Philco models which have a combined oscillator and first detector tube. After making the adjustment of the I.F. condensers on these models, be sure to make the low frequency adjustment as described below.

Ia. **COUPLING CONDENSERS.** Models 51 and 90 (with P.P. 47's) have "coupling condenser." This should now be adjusted in the same manner as described above.

II. **HIGH FREQUENCY ADJUSTMENTS.** It is the adjustment or setting of the H.F. and L.F. oscillator condensers which determines the position at which the stations will come in on the dial. Great care must therefore be taken with these adjustments. Improper adjustment of the high frequency compensating condenser is characterized by weak reception and poor selectivity at the high frequency end of the dial and by dial readings being off by more than 20 K.C. at this end of the dial. Proceed in the following manner:

1. Connect from the "A" terminal of the signal generator to the Antenna terminal of the broadcast receiver. All other connections remain the same as for adjustment of the I.F. compensating condensers. See Fig. 2 for complete connections.

2. Set the signal generator to 1400 K.C. Set the dial of the receiver to exactly 140 (1400 K.C.). (The eighth harmonic of 175 K.C. may be used). Turn the volume control to maximum. Adjust the attenuator until a $\frac{1}{2}$ scale reading is obtained on the output meter. If the receiver is badly out of adjustment, it may not be possible to obtain such a reading, in which case the meter reading must be disregarded temporarily and the adjustments made by ear.

3. Carefully adjust the high frequency compensating condenser for maximum reading in the output meter or for maximum volume if the output is not great enough to be read on the meter.

4. When making this adjustment, it may be found that a given position of the adjusting nut can be obtained at which maximum reading is noted, but that the meter reading decreases when the fibre wrench is lifted from the nut. Allow for this condition by turning slightly beyond the point of maximum reading, then when the wrench is removed the reading will go up instead of down.

5. If when a set is being adjusted on the high frequency and the signal generator set to generate at 1400 K.C., the signal is heard at an "off" point, say 1300 K.C., the set should be retuned by adjusting the other (antenna, H.F. or detector) condensers to maximum output at the "off" point; then retuning the set nearer 1400 and readjusting the H.F. condenser there. This alternate process can be repeated until the signal comes in to a maximum at 1400.

III. **ANTENNA, DETECTOR AND R.F. ADJUSTMENTS.** The adjustment of the antenna, detector and R.F. compensating condensers is done at 140 on the dial in the same manner and with the same connections as for the high frequency adjustments.

IV. **LOW FREQUENCY ADJUSTMENT.** The characteristics of improper adjustment of the low frequency condenser are weak reception, poor selectivity, and dial calibrations off more than 20 K.C. at the low end of the dial. The low frequency adjustment is made with the same connections as for the high frequency and antenna condenser adjustments. Proceed in the following manner:

1. With the receiver and the signal generator in operation, set the Philco dial at exactly 60 on the scale. Adjust the signal generator to 600 K.C.

2. With the volume control at maximum, adjust the signal generator output until the output meter reads approximately $\frac{1}{2}$ scale deflection. Adjust the low frequency compensating condenser for maximum reading in the output meter.

3. If the signal comes in stronger at a position off 60 on the Philco scale, adjust for maximum output on the meter at this "Off K.C." position of the dial. Now re-tune the set slightly to obtain any further possible increase, adjusting the compensating condenser and re-tuning the dial each time so as to bring the point of maximum output as near 60 as possible.

4. Re-set the dial to exactly 140, and re-adjust the high frequency condenser. It is possible that the adjustment of the low frequency condenser has affected the high frequency adjustment of the dial slightly.

V. SPECIAL INSTRUCTIONS—MODELS 53 and 54. See notes on page containing illustrations of these chassis.

ILLUSTRATIONS OF CHASSIS SHOWING LOCATION OF ADJUSTING CONDENSERS SUPERHETERODYNE MODELS

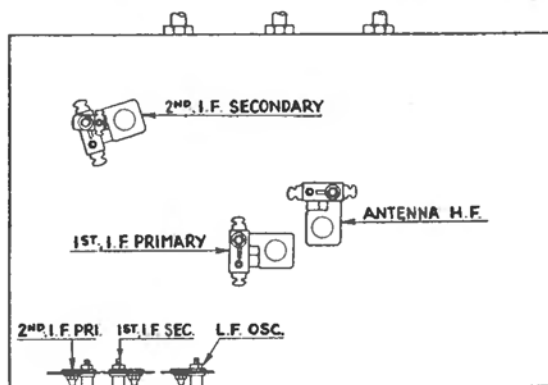

Fig. 3. Model 14 — (Codes 122 and 123) — I.F. 175

Model 14 — (Code 121) — See Model 91

NOTE: The "Osc. HF" and "Det" adjusting condensers are located on the tuning condenser assembly and are accessible from above.

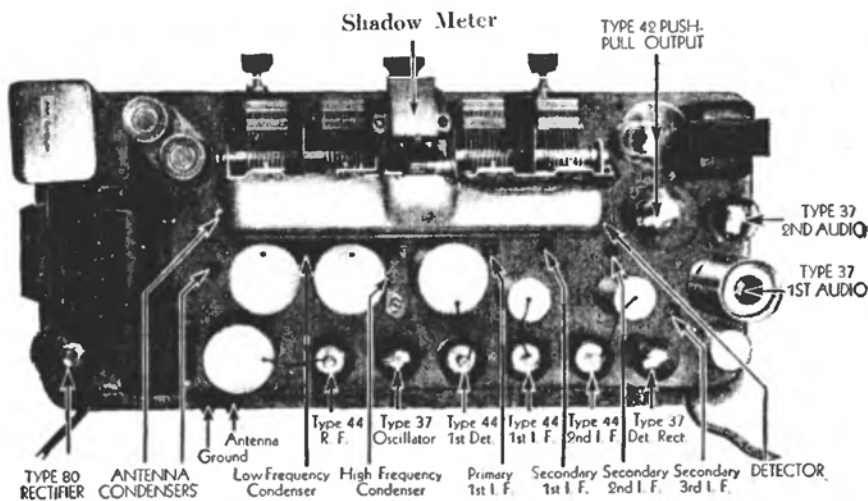

Fig. 4. Model 15 — I.F. 175 K.C.

Models 111 and 112 — Same Locations and I.F.'s

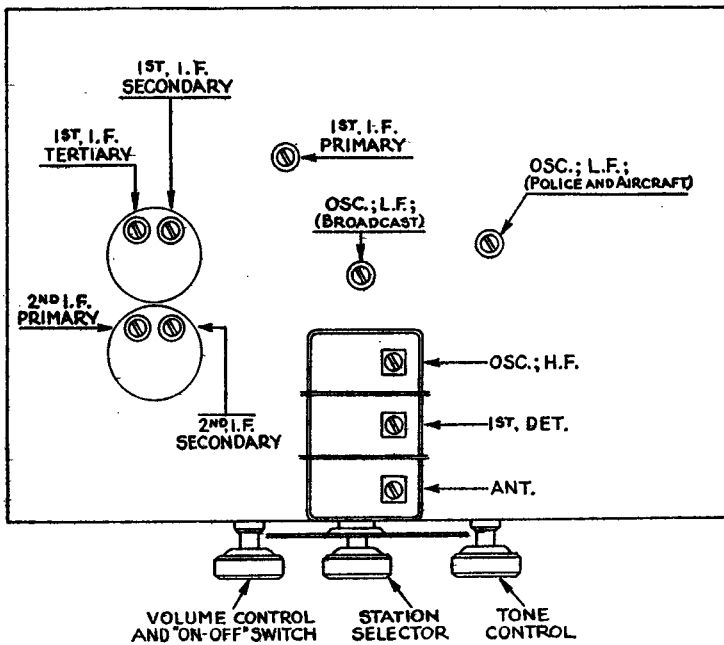

Fig. 5. Model 17 — I.F. 175 K.C.

NOTE: Adjust "OSC. LF (Police and Aircraft)" padder with signal-generator operating at 1700 K.C.

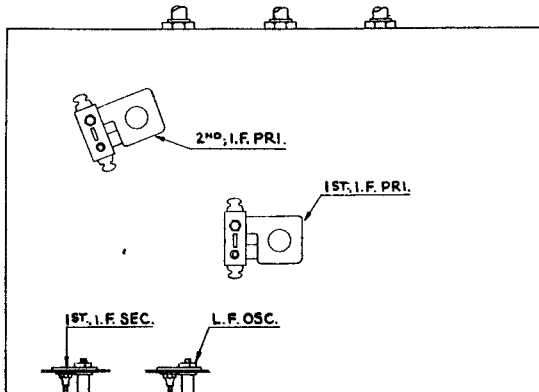

Fig. 6. Model 18 (bottom) I.F. 260 K.C.

The compensating condensers are situated:

(a) 1st I. F. PRIMARY — underneath chassis. Access from above through hole in sub-base, back of the Tuning Condenser Assembly. Shield covers the hole and may be removed by prying with a screw driver.

(b) 1st I. F. SECONDARY — at rear of chassis, beneath the two vertically mounted electrolytic condensers. Accessible from rear of chassis.

(c) 2nd I. F. PRIMARY — underneath chassis. Accessible from above through hole in chassis sub-base, in front of Type 42 (Driver; 2nd A. F.), and to right of Type 75 tube. The shield can be removed. The "OSC.; H. F." the "DETECTOR" and the "ANT.; H. F." compensating condensers are adjusted, in this sequence. The signal generator is set at 1500 K. C. for the "OSC"; at 1400 K. C. for the other two. These are mounted upon the Tuning Condenser Assembly. ANT. "HF" is mounted upon the condenser section nearest front.

The "OSC.; L. F." compensating condenser, located at rear of chassis is adjusted with the signal generator set at 600 K.C. It is accessible from rear of chassis. The Tuning Condenser should be "rocked" while the "OSC.; L. F." adjustment is made.

The "Push-on Button" shields should be replaced over 1st I. F. PRI and after the adjustments are finished.

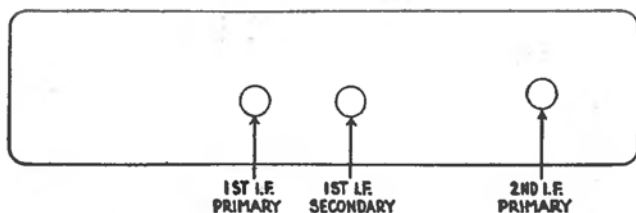

Fig. 7

Model 19 (back) — I.F. 260 K.C.

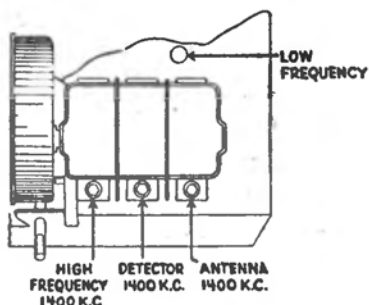

Fig. 8. Model 19 (Top View)

Model 89 — Same Locations — I.F. 260 K.C.

Model 26 — Same Locations — I.F. 460 K.C.

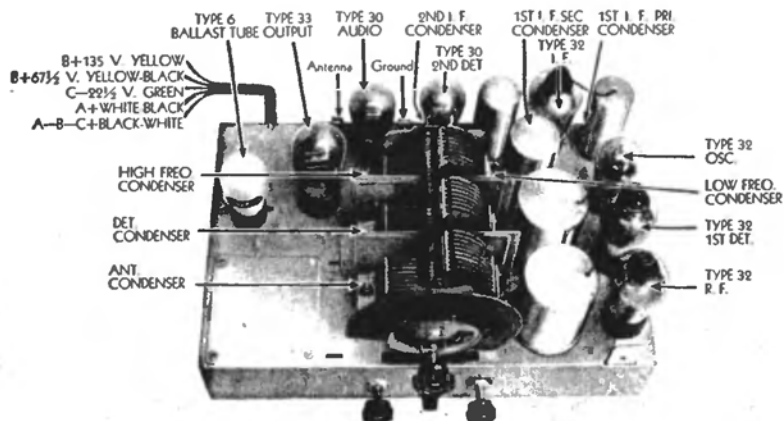

Fig. 9. Models 35 and 36 — (Battery Operated) — I.F. 260 K.C.

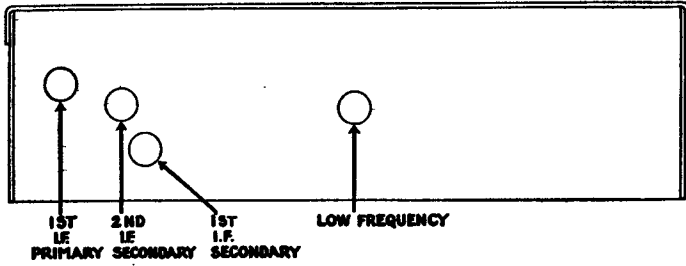

Fig. 10. Model 37 (back) — I.F. 175 K.C.

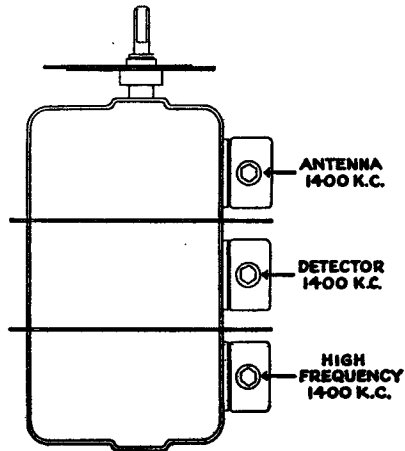

Fig. 11. Model 37 (top).

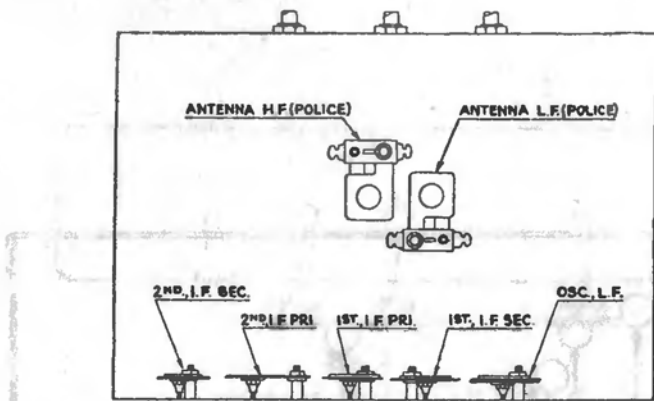

Fig. 12. Model 38 (Battery Operated) — I.F. 460 K.C.
(bottom view)

I.F. Adjustments are accessible from rear.

H.F. are mounted on tuning assembly, accessible from top.

H.F. "police" is reached thru opening in sub-base, to rear and left of tuning condenser (facing front). This is to be adjusted at 2400 K.C., which is obtained (as a harmonic) by setting the signal generator of the 048 Tester at 600 or 1200 K.C.

L.F. adjustments are located (1) Thru opening in chassis sub-base to right of "police" adj., and (2) on rear underside of chassis (accessible from rear).

"L.F. police" is adjusted with the signal-generator operating at 1700 K.C.

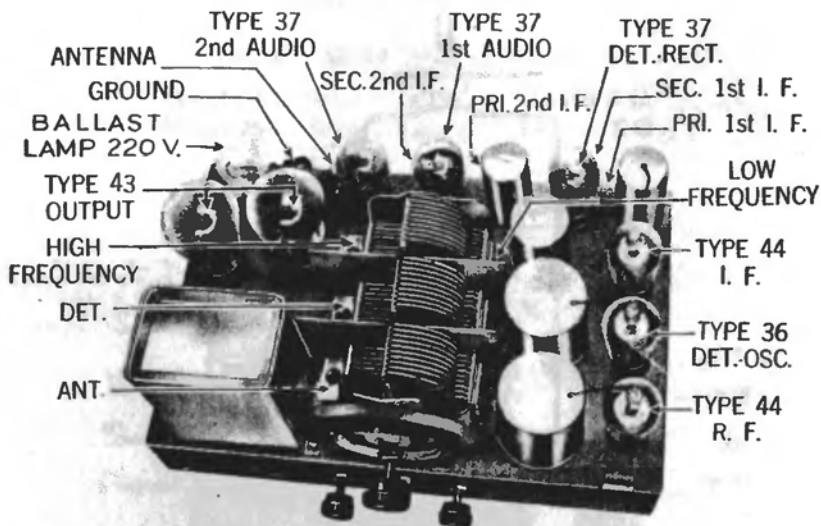

Fig. 13. Model 47 (D.C.) I.F. 260 K.C.

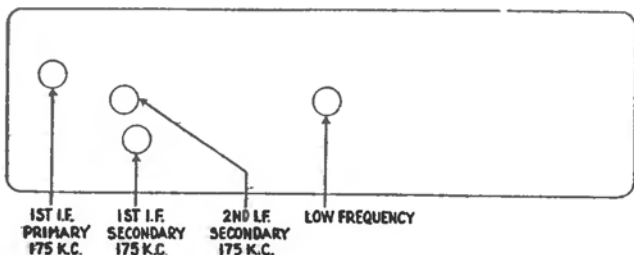

Fig. 14. Model 48 (back) — I.F. 175 K.C.

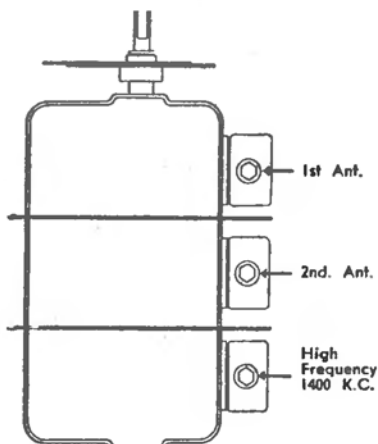

Fig. 15. Model 48 -- (Tuning Assembly)

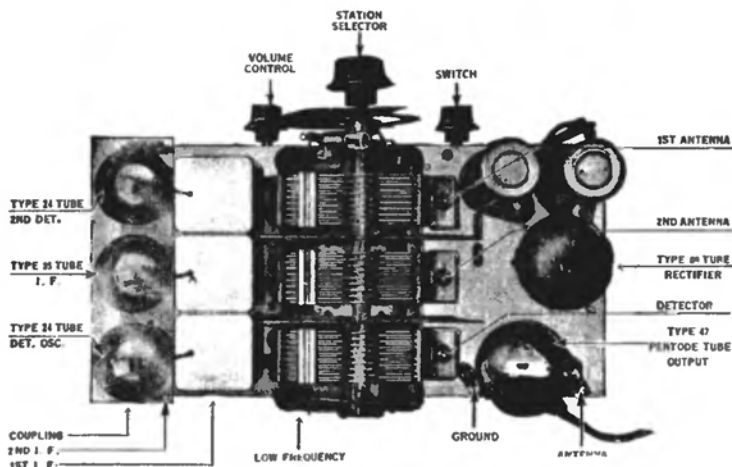

Fig. 16. Models 51 and 52 — I.F. 175 K.C.

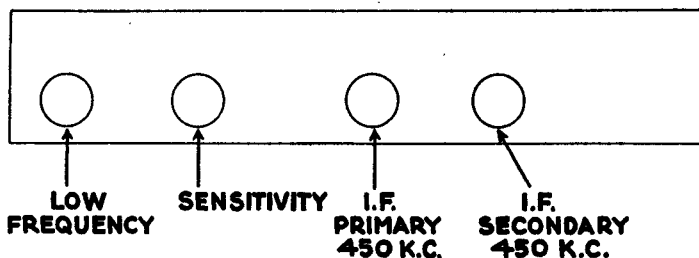

Fig. 17. Model 53 (back) — I.F. 460 K.C.

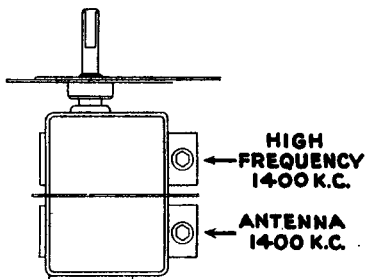

Fig. 18. Model 53 — (Tuning Assembly)

SPECIAL INSTRUCTIONS FOR MODEL 53

To obtain maximum sensitivity through the use of the 30' antenna wire it will be necessary to adjust the antenna compensating condenser, the low frequency compensating condenser and the sensitivity condenser in the following manner:— unroll the 30' antenna wire to its full length (do not connect it to another aerial or ground while the following adjustments are being made). Tune to a station near the high frequency end of the dial (between 1400 and 1500 K.C.). With a fibre adjusting wrench cut off, adjust the antenna condenser (Fig. 18) for maximum volume. After this is completed tune to a station near the low frequency end of the dial (as near 600 as possible) and then adjust the low frequency condenser (Fig. 17) for maximum volume; retune to the high frequency station and do any necessary fine re-adjusting so as to bring in the station with maximum volume. Now check the adjustments of the sensitivity condenser (Fig. 17) with the receiver tuned to a station near the high frequency end of the dial, turn this condenser to the right as far as possible without causing an oscillation or squeal. Repeat this adjustment on a station near the low frequency end of the dial; if an oscillation or squeal appears turn the condenser to the left until this disappears.

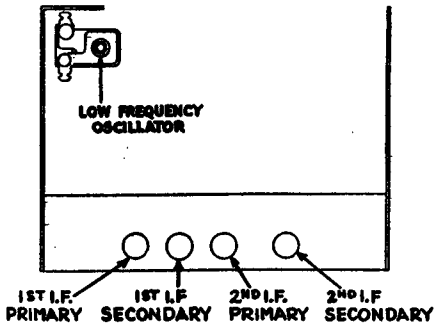

Fig. 19
Model 54 (back) — I.F. 460 K.C.

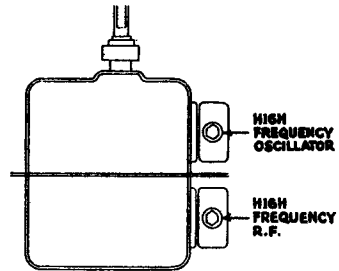

Fig. 20
Model 54 (Tuning Assembly)

NOTE: The adjustment of the High Frequency and Antenna compensating condensers can be accomplished by means of a screw driver through the top grille of the cabinet. The Low Frequency condenser is accessible from rear of cabinet.

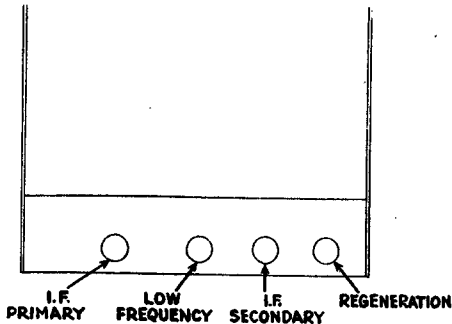

Fig. 21
Model 57 (back)—I.F. 460 K.C.

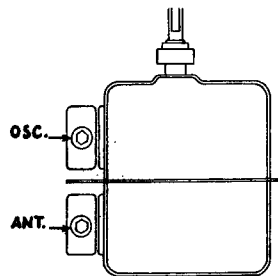

Fig. 22
Model 57 (Tuning Assembly)

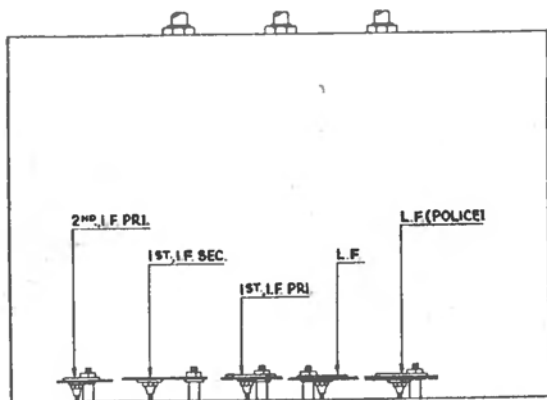

Fig. 23. Model 60 (bottom) — I.F. 460 K.C.

The three I.F. Condensers are accessible from the rear. H.F. and Ant. are mounted on tuning condenser assembly. L.F. Condensers are at rear. L.F. "police" is adjusted with the signal-generator operating at 1700 K.C.

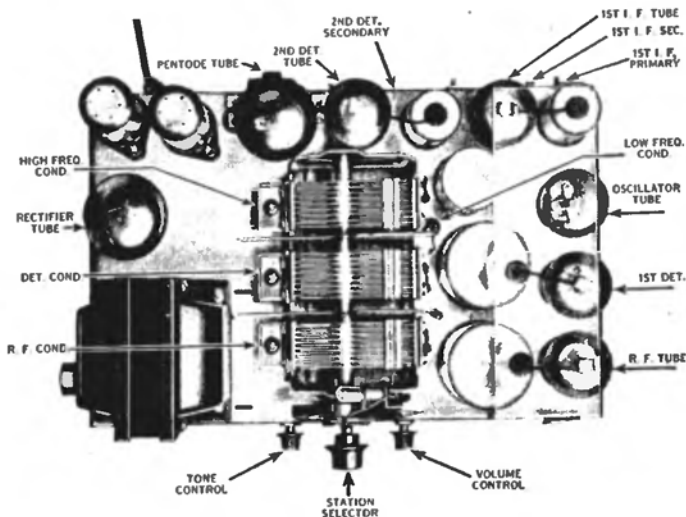

Fig. 24. Model 70 (without automatic volume control) — I.F. 260 K.C.

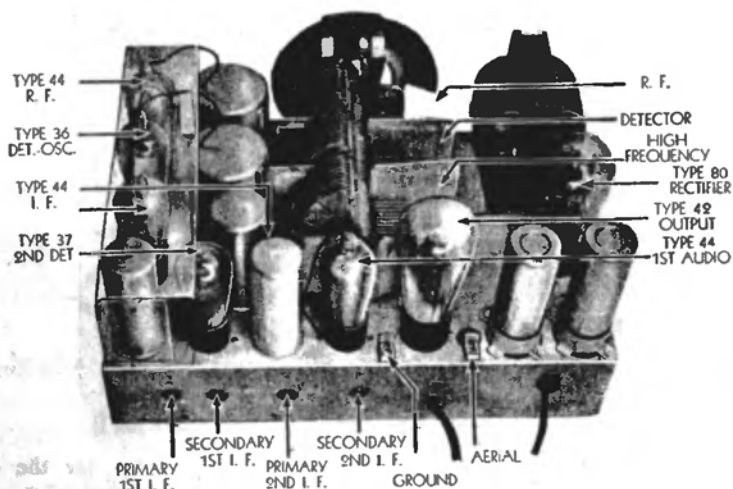

Fig. 25

Model 70 (with Automatic Volume Control) — I.F. 260 K.C.
 Models 71, 22, 470 — Same Locations and I.F.

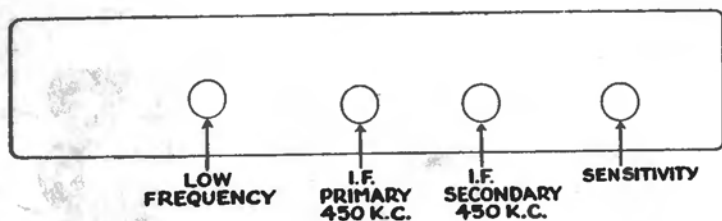

Fig. 26. Model 80 (back) — I.F. 460 K.C.

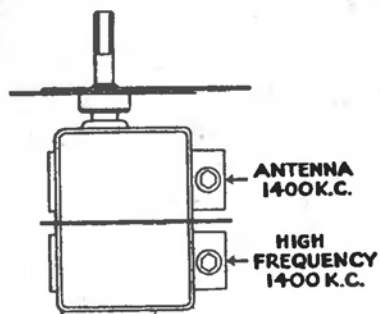

Fig. 27. Model 80 (Tuning Assembly)

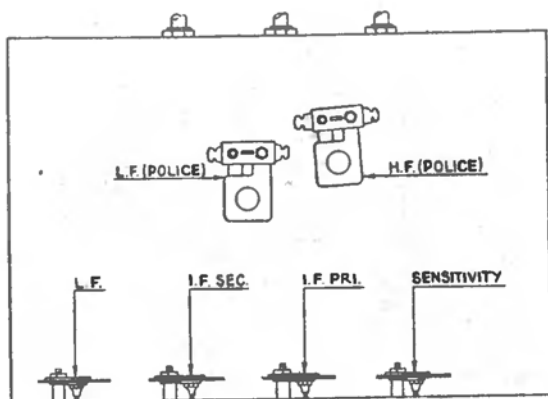

Fig. 28. Model 81 (bottom) — I.F. 460 K.C.

NOTE: The adjustments for police broadcasts are those near the center of chassis, reached from underneath. No. 1 is to be adjusted at 1700 K.C. and No. 2 at 2400 K.C. The other condensers are located the same as Model 80.

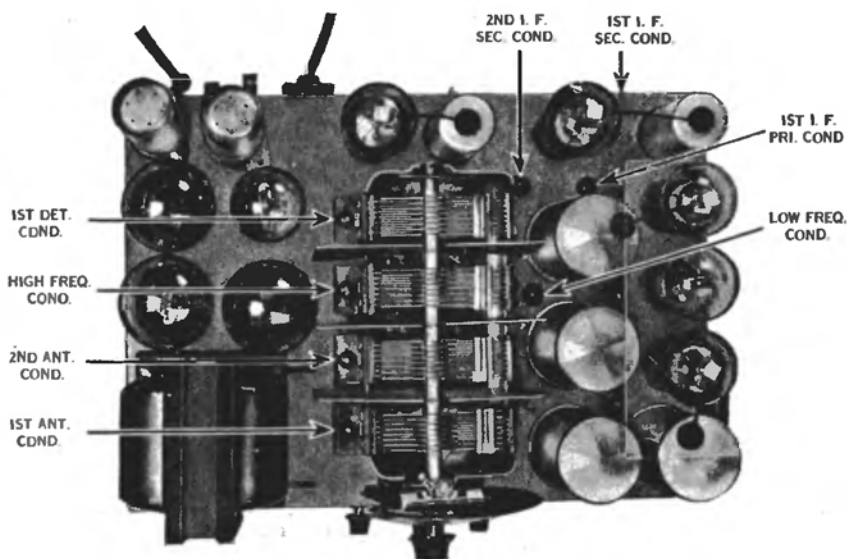

Fig. 29. Model 90 (P.P. 45's) — I.F. 175 K.C.
Model 90 with single 47 — Same Locations, I.F. 260 K.C.

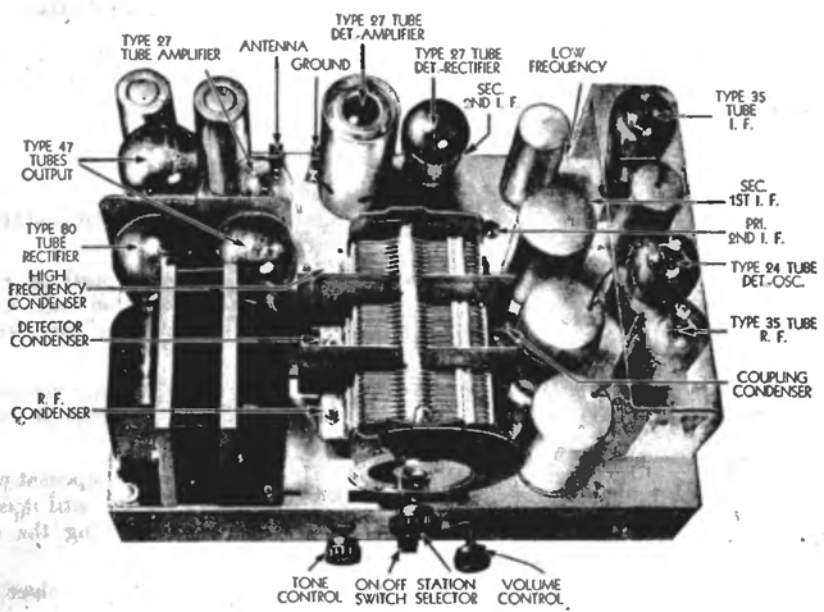

Fig. 30. Model 90 (with P.P. 47's) — I.F. 260 K.C.

Shadow Meter

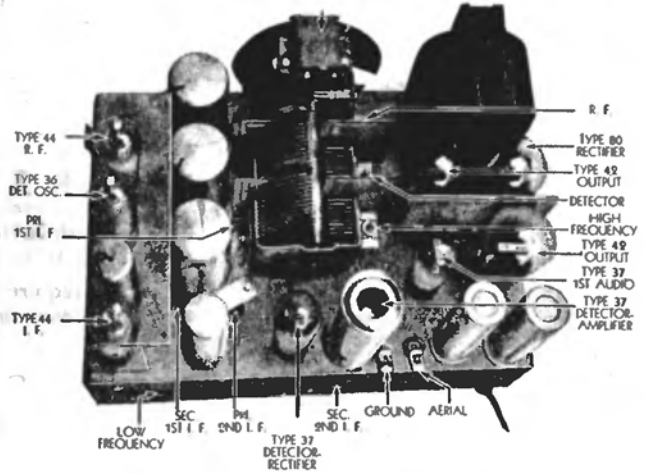

Fig. 31. Model 91 — I.F. 260 K.C.
 Models 23 and 490 — Same Locations and I.F.
 Model 14 (code 121) — Same location and I.F.

Part II. Adjusting Procedure — Tuned R. F. Models

The equipment used can be the same as recommended for adjusting Superheterodynes, that is, the Philco 048 All-Purpose Tester or its equivalent, and the fibre adjusting wrench.

Procedure:

(1) Models having only two adjustments.

In the earlier model tuned RF sets, only two compensating adjustments were provided.

1. Connect signal generator leads to Antenna and ground posts of receiver (a ground connection being made), turn volume control of receiver on full. Connect output meter terminals to output of receiver, as per instructions supplied with tester.

2. Adjust signal generator and receiver so that signal is being received between 1200 and 1400 (see table on Page 2). Reduce volume of signal to minimum by means of the attenuator.

3. With the fibre wrench, turn down adjusting nut on first compensating condenser (refer to list below for location of compensating condensers) until it is tight. This throws the first stage out of balance which permits adjusting the second stage accurately.

4. Adjust the second condenser for maximum signal, with the receiver accurately tuned to the signal from the signal generator.

5. Re-adjust the first condenser in the same manner.

(2) Models having three or more adjustments.

In tuned R.F. models having more than two adjustments, make connections to signal generator and output meter as just described, setting signal generator at frequency, indicated in table on Page 2, so that a low reading on meter is obtained.

Start with the last (No. 3 or No. 4) compensating condenser and adjust for maximum reading on output meter. Then adjust the next condenser (No. 2 or No. 3) and so on until all have been brought to maximum output meter reading.

Location of Adjusting Condensers — Tuned R. F. Models

Models 76 and 77: Adjusting condensers (2) are located on top of chassis, behind right-hand end of gang condenser assembly.

Model 65: The two adjusting condensers very seldom require adjustment in this model. They are located on back of condenser assembly inside same, and may be reached from rear thru opening in back of assembly frame.

Models 95 and 96: Located (4 in number) on top of chassis, behind gang condenser, and between R.F. transformers.

Models 20 and 50: Located (3 in number) on right side of frame of gang condenser assembly. May be reached from rear of set.

Model 30 (battery): Same locations as models 95 and 96.

Model 41 (DC): Two adjusting condensers located to right of gang condensers in front of first R.F. transformer.

Model 46 (DC): Located on each section of gang condenser. Adjust from above.

Part III. Adjusting Short-Wave Converter and Combination All-Wave Receivers

I. Adjusting the Model 43 and Model 25.

The Philco Model 43 Short-wave Combination Receiver can be adjusted by means of the signal generator in the Model 048 Tester. This signal generator provides the necessary frequencies for adjusting the intermediate frequency amplifier stages, and also for adjustments in the broadcast range. The other compensating

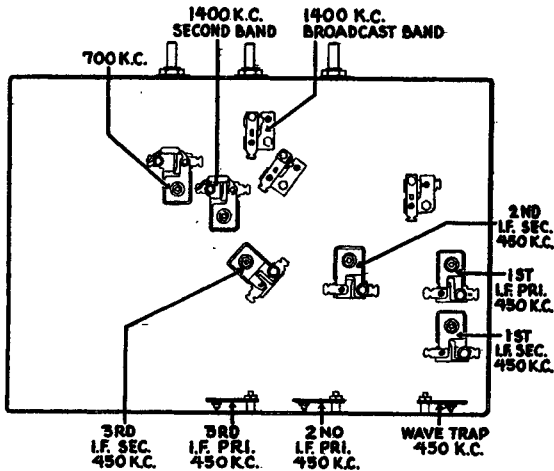

Figure 32

condensers (in short-wave range) are of special construction and will not require re-adjustment.

The following procedure should be used:

(1) Remove the control grid connection from the first detector tube, and substitute the antenna connection from the Philco 048 signal generator. Connect the output meter across the primary of the output transformer of receiver.

(2) Set the signal generator in operation at 460 K.C.

(3) Adjust the several I.F. compensating condensers successively for maximum output meter reading.

(4) Replace the control grid connection of the first detector tube, and connect Antenna lead from signal generator to the antenna terminal of the radio set; operate signal generator at 460 K.C. and adjust the wave trap for *minimum* reading in the output meter.

(5) Set signal generator at 700 K.C. and adjust the 700 K.C. condenser for maximum output meter reading.

(6) Re-set the signal generator to 1400 K.C. and receiver dial to 1400 on the bottom scale; adjust the 1400 K.C. condenser to maximum output meter reading.

(7) Tune the radio set to 1400 K.C. on the second scale from the bottom, and adjust this compensating condenser for maximum output meter reading.

NOTE: When adjusting the 1400 and 700 compensating condensers it may be found that the note from the signal generator will be heard 10 K.C. or more off the desired dial reading. This can be corrected by alternate adjustments and re-

tuning of the tuning condenser, bringing the signal nearer 700 or 1400 each time until maximum output meter reading is obtained with the correct dial scale reading.

Never attempt to make adjustment to any of the other compensating condensers in the receiver. It is important that the wires which connect between the R.F. coils and the wave change switch be so arranged that they will have maximum separation between them for minimum capacity losses.

Adjusting the Model 4 Short-Wave Converter

The adjustment of the compensating condensers in the Model 4 should be done with the aid of a Philco Model No. 091 Signal Generator. This instrument calibrated to give a signal at 3600 K.C. (3.6 M.C.). The various harmonics and image frequencies of this signal are used to adjust the compensating condensers at the different short-wave dial settings.

Connect the Model 4 to the broadcast receiver in the usual manner, with the ground wire connected and aerial disconnected. Set the dial of broadcast receiver at exactly 1000 K.C. (It is important that the broadcast receiver be accurately calibrated at this frequency).

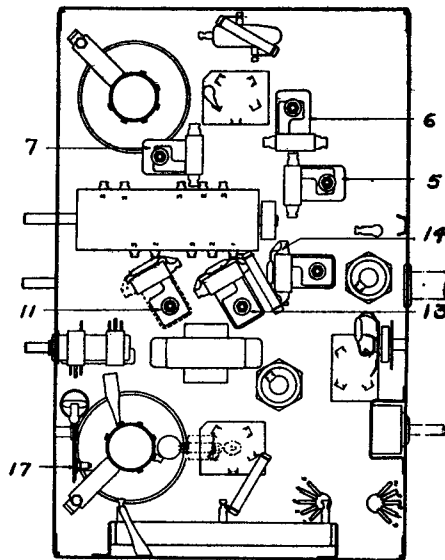

Figure 38

1. Adjusting at 3.6 megacycles on lower scale — Place the signal generator in operation and couple it with a wire to the antenna connection of the converter. Be sure the signal generator is grounded. Set the dial at 3.6 megacycles on the lower scale, and the frequency control switch of the converter in its proper corresponding position. Carefully adjust the compensator 7, shown in the illustration above, by means of your fibre wrench, until maximum signal is heard in the loudspeaker. It may be necessary to reduce the oscillator output by removing the oscillator from the coupling wire in order to obtain a faint input signal, the maximum strength of which can be readily determined by ear.

2. Adjusting at 1.6 megacycles — set the dial at 1.6 megacycles and adjust the compensating condenser 14 in the same manner as described above.

3. Adjusting at 7.2 megacycles — set the dial at 7.2 megacycles and set the frequency control switch in its proper position for the middle dial scale. Connect the signal generator output direct to the antenna terminal of the converter. Adjust the compensating condenser 6 for maximum output in the loudspeaker as described in the first adjustment.

4. Adjusting at 3.6 on middle scale — turn the dial to 3.6 on the middle scale and adjust the compensator 13 as described in the first adjustment.

5. Adjusting at 18. megacycles — set the dial at 18 and the frequency control switch in its corresponding position. Adjust the compensator 5 as described above. More than one signal will be heard as the adjustment is being made. Be sure to adjust for the one which is heard second as the compensating condenser capacity is reduced from its maximum (adjusting nut all the way in). When this adjustment has been made correctly, the oscillator signal can be heard at 18, 16, 14.4 and 12.4 megacycles. This adjustment is the most critical of any, and will require more care in getting the correct point.

6. Adjusting at 8.8 megacycles — (Early production). The early production of the short-wave converter used a compensating condenser for the 8.5 megacycle end of the high frequency dial. This part is replaced on later production with an 1800 mmf. fixed condenser, part 6022. Those with the compensating condenser can be adjusted in the following manner. Turn the dial to 8.8. Adjust the compensator 11 in the manner described in the first adjustment.

7. Re-setting 1000 K.C. Wave-trap.

A wave-trap tuned to 1000 kilocycles is connected in the antenna circuit of the converter for the purpose of suppressing any possible interference from nearby stations which might be broadcasting at or near 1000 kilocycles. If it is impossible to find a point between 950 and 1500 K.C. at which interference is not heard, the wave-trap 17 should be adjusted by means of the fibre wrench until the interfering station is tuned out.

Adjusting the Model 16

The adjustment of the compensating condensers in the Philco Model 16 is more complicated than in the ordinary broadcast receiver, although the principle of the adjustments is essentially the same. Because of the nature of this work it is not recommended that the service man undertake the adjustments without first studying these instructions carefully.

An accurately calibrated intermediate frequency signal generator is required for adjustments of the I.F. circuits. Harmonics of this generator are used for R.F. adjustments in the broadcast band. The Philco Model No. 048 All Purpose Set Tester is recommended.

The Philco Model No. 091 crystal controlled signal generator is needed for adjustments in the short-wave band. This generator has a fundamental frequency of 3600 K.C. (8.6 M.C.), controlled accurately at all times by the crystal. The fundamental frequency of the generator is sufficiently high that strong harmonics can be used for adjustment in the higher frequency bands. These harmonics are heard sufficiently far apart on the dial so that there is no difficulty experienced in distinguishing one frequency from another. Such would not be the case if a signal generator of lower fundamental frequency were used.

The following frequencies * generated by the Model No. 091 oscillator are employed in the various adjustments of the short-wave band in the order listed:

- 10.8 Megacycles
- 21.6 Megacycles
- 5.2 Megacycles
- 3.6 Megacycles
- 1.57 Megacycles

Referring to the top and bottom views of the Model 16 chassis as illustrated on page 27, the adjustments are made in the following manner in the order outlined:

Adjustment of I.F.

1. Remove the antenna connection from the receiver, disconnect the grid clip from the first detector of the Model 16 (see top view of chassis for location), and connect the "Ant." output terminal of the signal generator to the grid of the first detector tube; connect the GND terminal of the signal generator to the GND terminal of the receiver.

2. Connect the 0-100 volt range of the output meter to the primary terminals of the output transformer, or to the plate terminals of the two output tubes, whichever is more convenient.

3. Place the signal generator in operation at 460 K.C. and place the receiver in operation with the volume control set at maximum. Adjust the attenuator of signal generator for approximately half scale reading of the output meter.

4. Using the Philco fibre adjusting screw driver, Part No. 27-7059, adjust each of the I.F. compensating condensers in turn (shown in the top view chassis illustration) to give maximum reading on the output meter. If the receiver is badly out of adjustment, it may be necessary, in order to avoid the meter needle going off scale, to reduce the setting of the attenuator from time to time as the successive I.F. adjustments are completed.

Adjustment of Wave-Trap

1. Remove the signal generator connection to the first detector grid, and connect to the antenna terminal of the receiver. Replace the grid clip on the first detector grid cap.

2. Set the wave-band switch of the receiver in the broadcast position (Range No. 1, 520-1500 K.C.), and set the station selector at 520 K.C.

3. With the signal generator in operation at 460 K.C., adjust the wave trap condenser (see bottom chassis view for location) until a *minimum* reading is obtained on the output meter. The Philco fibre wrench, part No. 3164, is used for this adjustment and also for the adjustment of the other condensers on the underside of the chassis. In locations where a powerful commercial station is operating on a frequency near 460 K.C., so as to cause interference, it may be desirable to adjust the wave trap to the frequency of the station rather than to exactly 460 K.C. By adjusting the trap for minimum output from the station signal it should be possible to eliminate all interference.

*For those interested, the following is an explanation of the different frequencies: 10.8 M.C. is the third harmonic of 3.6 M.C.; 21.6 M.C. is the sixth harmonic of 3.6 M.C.; 5.2 M.C. is produced by beating of the second harmonic of receiver oscillator with the third harmonic of 3.6 M.C. $2 \times (5.2 + .46) - (3 \times 3.6) = .52 \times 10 = 5.2$ M.C.; 3.6 M.C. is the fundamental frequency of the No. 091 signal generator; 1.57 M.C. is produced by beating the second harmonic of the receiver oscillator (4.06 M.C.) with the 3.6 M.C. fundamental of the No. 091 signal generator $[(1.57 + .46) \times 2] - 3.6 = .46$ I.F., which is heard when the set is tuned to 1.57 M.C.

Adjustment of High Frequencies

CAUTION: Never attempt to adjust the two end tuning condensers shown in the top view illustration of the chassis. Servicemen are cautioned against attempting to make such an adjustment, since special signal generator equipment, available only in the Philco factory, is needed for this adjustment. These condensers are carefully regulated and sealed in the factory; they will not require re-adjustment in the field.

In the procedure given below, the frequency ranges are referred to as follows:

Range 1	520 K.C. to 1500 K.C.
Range 2	1.5 M.C. to 4.0 M.C.
Range 3	3.2 M.C. to 6.0 M.C.
Range 4	5.8 M.C. to 12.0 M.C.
Range 5	11.0 M.C. to 23.0 M.C.

The compensating condensers to be adjusted in the different high frequency and in the broadcast frequency bands are referred to in the chassis illustrations as numbers 1, 2, 3, 4, 5, and 6 in the order of adjustments. With each number is given the dial setting at which the adjustment is made.

1. Connect the output terminals of the 091 signal generator to the antenna and ground terminals of the receiver, and place the 091 in operation.

2. Place the wave band-switch of the receiver on Range 4, and tune the station selector to 10.8 megacycles, at which point the signal from the 091 will be heard. Adjust No. 1 compensating condenser located on front section of the tuning condenser to give maximum reading in the output meter.

3. Place the wave-band switch on Range 5, and tune the station selector to 21.6 megacycles. The signal from the 091 should be heard at this point. There is no adjusting condenser for this frequency. If the signal is not heard within a reasonable distance (100 K.C.) on either side of 21.6, it will be necessary to re-adjust slightly the 10.8 megacycle adjustment described in No. 2 above, so as to care for the 21.6 megacycle adjustment. Such re-adjustment will cause a slight error in the 10.8 M.C. setting. The error at the two points (10.8 and 21.6) must be split in proportion to the frequencies. Care must be taken not to mistake the image frequency of 21.6 M.C. which also can be heard at approximately 20.7 M.C.

4. Set the wave-band switch on Range 3, and tune the station selector to 5.2 M.C.

5. Adjust the compensating condenser No. 2 as shown on the bottom chassis view, for maximum output meter reading. The signal which will be heard at or near 5.2 M.C. will be somewhat weaker than the other signals from the 091.

6. Set the wave-band switch on Range No. 2 and tune the station selector to 3.6 M.C. Disconnect the antenna connection between the oscillator and the receiver. This is necessary because of the high output from the signal generator at this frequency.

7. Adjust the compensating condenser No. 3 as shown on the bottom chassis view, for maximum output meter reading.

8. With the wave-band switch still on Range No. 2, tune the station selector to 1.57 M.C. Normally, it is necessary to replace the antenna connection between the signal generator and the receiver for this adjustment.

9. Adjust the compensating condenser 4 as shown on the bottom chassis view, for maximum output meter reading.

10. Set the wave-band switch on Range No. 1 and tune the station selector to 1400 K.C.

11. Disconnect the No. 091 from the antenna and ground terminals and substitute the I.F. signal generator, such as the Philco Model No. 048. Place this in operation at 175 K.C. The eighth harmonic of this frequency will be heard at 1400 K.C.

12. Adjust the compensating condenser No. 5 as shown on the bottom chassis view for maximum output meter reading.

13. Place the signal generator in operation at 520 K.C. and tune the receiver to 520 K.C.; adjust the compensating condenser No. 6 for maximum output meter reading.

This completes the adjustments and the receiver is now ready for operation. In all cases, the adjustments of the Model 16 should be made in the sequence given above.

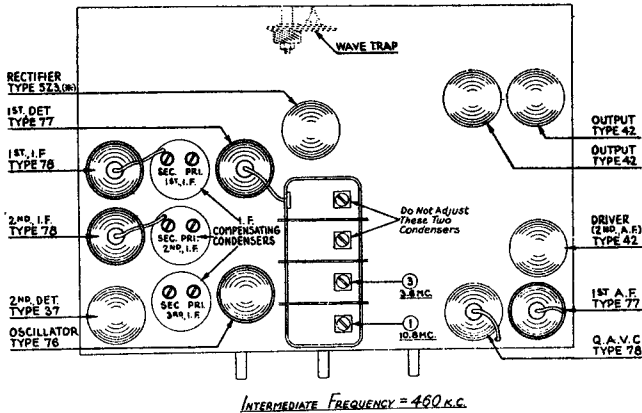

Fig. 34. Top View — Model 16 Chassis
Showing Location of Compensating Condensers

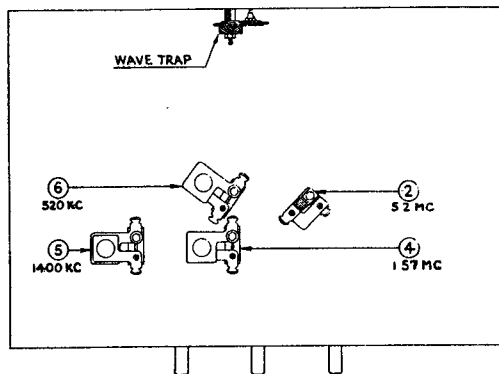

Fig. 35. Bottom View — Model 16 Chassis
Showing Location of Additional Compensating Condensers

Adjusting Model 44

The procedure of adjusting Model 44 Long and Short-Wave Receiver follows very closely that of the Model 16. The chief difference is due to the fact that the 44 has three Short-Wave Bands instead of the four on the Model 16.

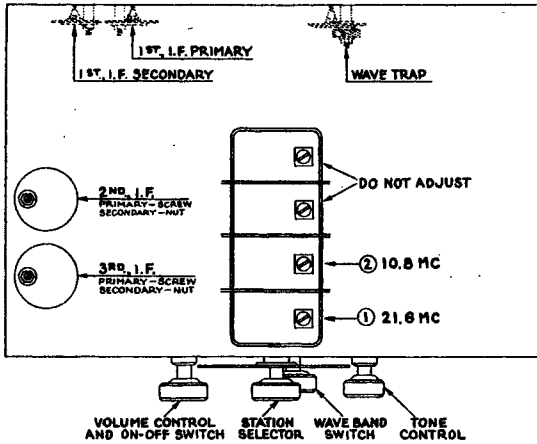

Fig. 36

By referring to the illustrations below you will note the locations of the I.F. compensators, primary, secondary, wave trap, and the adjustments located on the condenser gang and under the chassis. The two condensers on the rear sections of the gang are correctly adjusted and sealed at the factory and should not be touched.

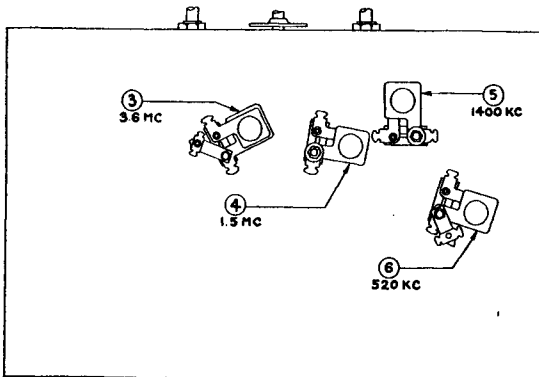

Fig. 37

Two of the adjustments of the dial frequencies are made by the compensating condensers on the first (nearest panel) two sections of the gang. Condenser No. 1 is the adjustment for Range 4 (dial set at 21.6), No. 2 for Range 3 (dial set at 10.8).

Condenser No. 3 is located underneath chassis and reached from beneath, for Range 2 adjustment (dial set at 3.6 M.C.). Be sure the wave-band switch is at the proper position when making each adjustment. Condenser No. 4 (also underneath chassis, Fig. 37) is next adjusted, this time using the Philco 048 signal generator or its equivalent, setting it for a signal of 1500 K.C. Condensers Nos. 5 and 6 (Fig. 37) are used to make the high frequency and low frequency adjustments in the broadcast band, setting the signal generator at 1400 and 520 K.C., respectively.

Part IV. Adjusting Condensers; "Neutrodyne Plus" Models

1. Padding Condensers.

The Philco Model 048 Tester will be very satisfactory for adjusting the padding condensers on the "Neutrodyne Plus" models.

Connect the antenna and ground leads from the signal generator to the corresponding posts of the receiver. Set the signal generator at about 700 K.C. and turn on the receiver and generator. Turn volume of set full "on."

Adjust the attenuator control on the signal generator so that the reading on the output meter is low.

Adjust each of the padding condensers, by means of the special fibre wrench, until maximum reading on the output meter is obtained in each case.

2. Neutralizing Condensers.

The "Neutrodyne Plus" models contain, in addition to the padding condensers, several other small condensers known as neutralizing condensers. These also must be adjusted in order for the receiver to function to a maximum.

Use the same connections for the signal generator as above described.

A "dummy" tube, type 226, will be required. This is obtained by cutting off one filament prong of a tube of this type. Insert this tube in the third R.F. socket, and then adjust the third R.F., neutralizing condenser so that minimum reading is obtained on the output meter.

Repeat this procedure with the second and first R.F. stages, placing the dummy tube in the corresponding socket each time.

3. Location of Adjusting Condensers — "Neutrodyne Plus" Models.

Figure No. 38 illustrates the bottom of chassis of Model 511 "Neutrodyne Plus" receiver. Nos. 1, 2, and 3 are padding condensers, and 4, 5 and 6 are neutralizing condensers.

In Models 86 and 87, "Neutrodyne Plus" Sets, the adjusting condensers are located on top of the chassis, the padding condensers being in front of the main condenser gang, and the neutralizing condensers in the back.

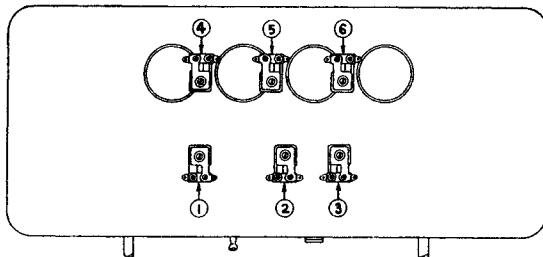

Fig. 38. Model 511

Part V. Adjusting Philco Auto Radios

Model 3

The Model 3 is a T R. F. Receiver and is equipped with three compensating or padding condensers, mounted on the tuning condenser housing. They can only be adjusted by using a special fibre wrench inserted in the holes provided for this purpose in the bottom of the Receiver (The normal mounting of the Model 3 is with the tubes inverted). The holes are covered with a dust proof cover plate which must be removed before padding.

With the signal generator and the Receiver set up for operation (and with the output meter connected) set the signal generator to a frequency between 1000 and 1200 K. C. Tune the Receiver sharply to the signal and then adjust the attenuator until a half scale deflection is obtained on the output meter. The Receiver volume control must be turned full on.

Using the special fibre wrench, adjust the third compensating condenser to the point at which the maximum reading is obtained on the output meter. Then adjust the second and finally the first compensating condenser in the same manner. Always adjust for the maximum reading on the meter.

Model 5

The intermediate frequency used is 460 K.C. Set up the signal generator for this frequency.

Disconnect the grid lead from the 6A7 tube. Then connect the test lead to the grid of this tube and ground the shield on the Receiver housing. Use the fibre adjusting wrench for all adjustments.

Padder "LF." Turn the adjusting nut in until tight. Then back off one full turn. Leave this condenser in this position until the last step.

Now adjust the first I.F. primary condenser. With the Receiver and signal generator turned on and the signal generator set for 460 K. C., turn the Receiver volume control on full and adjust the attenuator. Then adjust the padder for maximum reading on the output meter.

Next adjust the first I. F. secondary condenser. Adjust the attenuator so that a half scale reading is obtained. This should be repeated with each adjustment if necessary. Adjust the padder for maximum reading. Repeat this procedure in the next two adjustments.

The next adjustment in order is the second I.F. primary condenser. This is then followed by the second I.F. secondary condenser. These are indicated on the illustration. (Fig. 39).

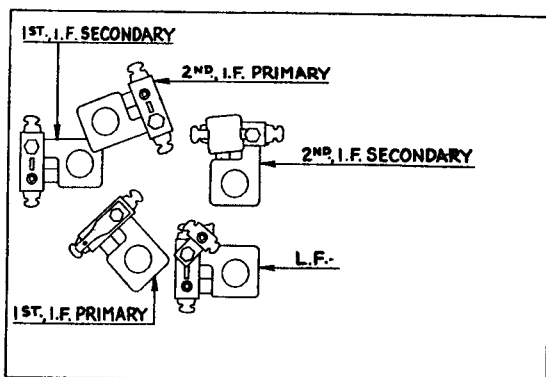

Fig. 39. Model 5 — I.F. 460 K.C.

Remove the signal generator connections from the 6A7 tube and reconnect the Receiver grid lead to this tube. The signal generator setting must now be changed to 1500 K. C.

The Receiver volume control must be turned on full, the oscillator lead connected to the antenna lead-in and the shield to the Receiver housing. To obtain the correct setting of the tuning condenser, open the plates as wide as possible. Place a piece of paper on the stator plates and then turn the rotor out until it strikes the paper.

Oscillator Adjustment. This is the padder on the second section of the tuning condenser (section nearest drive mechanism) Adjust for maximum reading.

Antenna Adjustment. This is the remaining padder on the tuning condenser. Remove the paper from the tuning condenser and set the condenser and signal generator for 1400 K.C. Adjust the padder for maximum reading.

Low Frequency Adjustment. Set the signal generator for 600 K. C. and tune the Receiver to this frequency. Adjust the padder for maximum reading. After completing these operations, readjust the antenna padder at 1400 K. C.

Models 6, 9 and 12 (Code 122)

I. F. Stages. Remove the grid clip from the detector-oscillator tube and connect the output of the signal generator to the control grid. The detector-oscillator is the second tube from the right.

With the Receiver and signal generator turned "on," set the signal generator for 260 K. C. and adjust the attenuator so that a half scale reading is obtained on the output meter, with the Receiver volume control turned on full.

Using a Philco fibre wrench, adjust the second I. F. condenser.

The correct adjustment is obtained when the maximum reading is secured on the meter.

Next adjust the secondary and primary I.F. condensers. These are the right-hand ones on Fig. 40.

Disconnect the signal generator and reconnect the clip to the control grid.

High Frequency Adjustments. Connect the output of the signal generator to the antenna lead and the housing of the Receiver. With the Receiver turned on and the signal generator set for 1400 K.C., tune the Receiver to 1400 K.C., and adjust the third padder on the tuning condenser for maximum signal. This is the one on the extreme left of the housing. The purpose of this adjustment is to line up the condenser so that 1400 K. C. is tuned in at 140 on the scale when the scale is set properly.

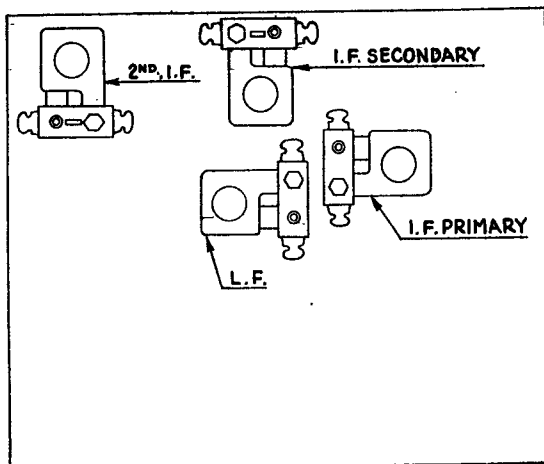

Fig. 40. Models 6, 9, and 12 (Code 122)
I.F. 260 K.C.

It may be necessary to adjust the first two compensators on the tuning condenser at 1400 K. C., in order to get a strong enough signal through.

R. F. Adjustments. After the detector-oscillator has been padded at 1400 K. C., adjust the first and second R. F. Condensers on tuning condenser at 1400 K. C.

Low Frequency Adjustment. Now tune the Receiver and signal generator to 700 K.C., and adjust the condenser (LF) on Fig. 40. During this operation the tuning condenser must be shifted and the compensator must be adjusted to bring in the maximum signal.

After this has been done, check the adjustment of the high frequency condenser at 1400 K. C. again.

Models 7, 8, and 12 (Code 121)

Intermediate Frequency or I.F. Stages—Remove the grid clip from the detector-oscillator tube and connect the output of the signal generator to the control grid. The detector-oscillator is the second tube from the right.

With the Receiver and signal generator turned "on," set the signal generator for 175 K. C. Adjust the attenuator so that a half scale reading on the output meter is obtained with the Receiver volume control turned on full.

Using a Philco fibre wrench, adjust the second I. F. condenser. This is the one in the upper left-hand corner of Fig. 41.

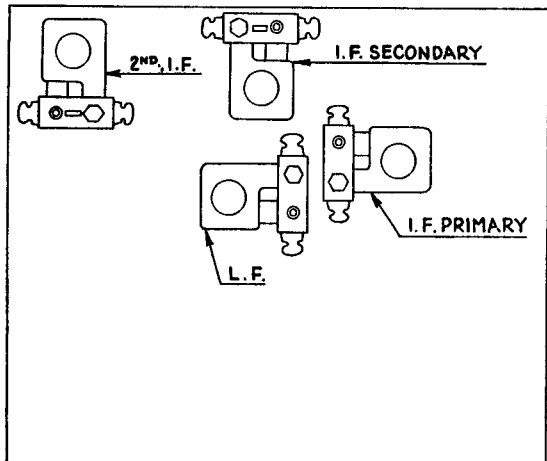

Fig. 41. Model 7. — I.F. 175 K.C.

The correct adjustment is obtained when the maximum reading is secured on the meter.

Next adjust the secondary and primary I. F. condensers. These are the two shown at the right on Figs. 41 and 42.

Disconnect the signal generator lead and reconnect the clip to the control grid.

High Frequency Compensator—Connect the output of the signal generator to the antenna lead and the housing of the Receiver. With the Receiver turned on and the signal generator set for 1400 K. C., tune the Receiver to 1400 K. C., and adjust the third padder on the tuning condenser for maximum signal. This is the one on the extreme left of the housing. The purpose of this adjustment is to line up the condenser so that 1400 K. C. is tuned in at 140 on the scale when the scale is set properly.

It may be necessary to adjust the first two compensators on the tuning condensers at 1400 K. C., in order to get a strong enough signal through.

R.F. Compensators—After the detector-oscillator has been padded at 1400 K. C., adjust the first and second R. F. Condensers at 1400 K. C.

Low Frequency Condenser—Set the signal generator to 700 K.C. Now tune the Receiver sharply. Adjust the L. F. condenser shown near the center of Figs. 41 and 42. During this operation the tuning condenser must be shifted and the compensators must be adjusted to bring in the maximum signal.

After this has been done, check the adjustment of the high frequency condenser at 1400 K. C. again.

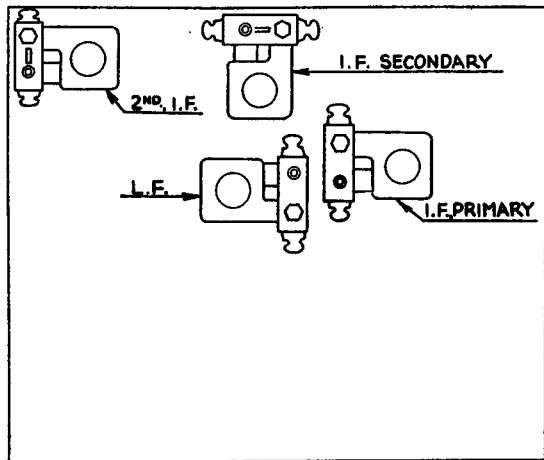

Fig. 42. Models 8 and 12 (Code 121)
I.F. 175 K.C.

Model 10

I. F. A new style I. F. transformer complete with adjusting condensers is used in the Model 10.

The condensers are placed in the top of the shield can, one above the other. The primary I. F. condenser is adjusted by means of the screw slot, accessible through the hole in the top of the shield can. The secondary is adjusted by means of the small hex nut, also accessible through the hole in the top of the shield can. Remove the speaker lid from the Receiver and disconnect the antenna lead from the Receiver. Remove the grid cap from the 6A7 tube (for location see Fig. 4

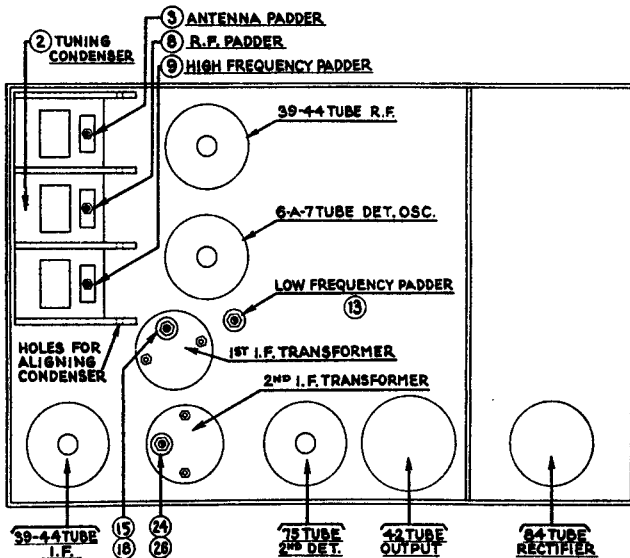

Fig. 43. Model 10 — I.F. 260 K.C.

Set up the signal generator and adjust it to exactly 260 K. C. Connect signal generator lead to the grid cap of the 6A7 tube. (See Fig. 43). The output meter must be connected by means of an adapter to the speaker prong of the speaker plug and to the chassis.

The Receiver volume control must be turned on approximately full volume and the attenuator in the signal generator set for a half-scale reading of the output meter.

The condensers 24 and 29 are adjusted first (Fig. 43). Turn the adjusting screws all the way in. A meter screw driver can be used for this. Then, with general attenuator set so there

approximately half-scale reading, adjust the nut with a fibre wrench for the maximum reading on the output meter.

Then adjust the screw for maximum reading on the meter. This adjustment is critical. Note the maximum reading obtained and then turn the screw in again and readjust, just bringing the adjustment up to the maximum reading. Do not pass it and then back off.

Repeat the above procedure with the condensers 15 and 18.

After adjusting the first I. F. stage, remove signal generator lead from the 6A7 tube and reconnect the grid lead to the 6A7 tube. Connect the antenna lead to the Receiver. Set signal generator to 1500 K.C. and then connect signal generator lead to the antenna lead.

H. F. There are four holes in line, one in each of the sections of the tuning condenser housing. (See Fig 43) Place a nail of the size that fits snugly through the holes and then turn the condenser plates out of mesh until they strike against the nail.

With the tuning condenser in this position adjust the high-frequency condenser until the maximum reading is obtained in the output meter. This is the true setting for 1500 K. C., 150 on the dial scale.

R.F. and Ant. Next turn the condenser plates in mesh to 140 on the scale, 1400 K. C., and set the signal generator for 1400 K. C. Adjust R. F. condenser and the antenna condenser for maximum reading on the output meter.

L.F. Turn the condenser plates in mesh to 60 on the scale, 600 K. C., and readjust the signal generator to this frequency. Adjust the low-frequency condenser for the maximum meter reading.

Recheck the adjustments and then remove all test leads. If this procedure has been carefully followed and an accurately calibrated oscillator or signal generator used, the Receiver is adjusted properly.